

ENGLISH

iFX-640

V1

Product code: 41552

Preface

Thank you for purchasing this Infinity product.

The purpose of this user manual is to provide instructions for the correct and safe use of this product.

Keep the user manual for future reference as it is an integral part of the product. The user manual shall be stored at an easily accessible location.

This user manual contains information concerning:

- Safety instructions
- Intended and non-intended use of the device
- Installation and operation of the device
- Maintenance procedures
- Troubleshooting
- Transport, storage and disposal of the device

Non-observance of the instructions in this user manual may result in serious injuries and damage of property.

©2021 Infinity. All rights reserved.

No part of this document may be copied, published or otherwise reproduced without the prior written consent of Highlite International.

Design and product specifications are subject to change without prior notice.

For the latest version of this document, please visit our website www.highlite.com or contact us at service@highlite.com.

Highlite International and its authorized service providers are not liable for any injury, damage, direct or indirect loss, consequential or economic loss or any other loss arising from the use of, or inability to use or reliance on the information contained in this document.

Table of contents

1. Introduction	4
1.1. Before Using the Product	4
1.2. Intended Use	4
1.3. Product Lifespan	4
1.4. LEDs Lifespan	4
1.5. Text Conventions	4
1.6. Symbols and Signal Words	5
1.7. Symbols on the Information Label	5
2. Safety	6
2.1. Warnings and Safety Instructions	6
2.2. Requirements for the User	8
3. Description of the Device	9
3.1. Front View	9
3.2. Back View	10
3.3. Base Plate	11
3.4. Product Specifications	12
3.5. Dimensions	13
4. Installation	15
4.1. Safety Instructions for Installation	15
4.2. Personal Protective Equipment	15
4.3. Installation Site Requirements	15
4.4. Rigging	15
4.5. Connecting to Power Supply	17
4.6. Power Linking of Multiple Devices	17
5. Setup	18
5.1. Warnings and Precautions	18
5.2. Stand-alone Setup	18
5.3. DMX Connection	18
5.3.1. DMX-512 Protocol	18
5.3.2. DMX Cables	19
5.3.3. Master/Slave Setup	19
5.3.4. DMX Linking	20
5.3.5. DMX Addressing	20
6. Operation	21
6.1. Safety Instructions for Operation	21
6.2. Control Modes	21
6.3. Control Panel	22
6.4. Start-up	22
6.5. Menu Overview	23
6.6. Main Menu Options	24
6.6.1. DMX Address	24
6.6.2. DMX Channel Mode	25
6.6.3. Settings Menu	26
6.6.3.1. Color Balance	27
6.6.3.2. Life Time	27
6.6.3.3. Set Password	27
6.6.4. Settings Menu	28
6.6.5. Reset Functions	28
6.6.6. Built-in Programs	28
6.6.7. Test Menu	29
6.6.8. Information Menu	30
6.7. DMX Channels	31
6.7.1. DMX Channels Overview	31
6.7.2. 24 channels, 86 channels	33
6.7.3. 53 channels, 59 channels	39

- 7. Troubleshooting45**
- 8. Maintenance46**
 - 8.1. Safety Instructions for Maintenance46
 - 8.2. Preventive Maintenance46
 - 8.2.1. Basic Cleaning Instructions47
 - 8.3. Corrective Maintenance47
 - 8.3.1. Replacing the Fuse.....47
- 9. Deinstallation, Transportation and Storage48**
 - 9.1. Instructions for Deinstallation.....48
 - 9.2. Instructions for Transportation48
 - 9.3. Storage48
- 10. Disposal48**
- 11. Approval.....48**

1. Introduction

1.1. Before Using the Product



Important

Read and follow the instructions in this user manual before installing, operating or servicing this product.

The manufacturer will not accept liability for any resulting damages caused by the non-observance of this manual.

After unpacking, check the contents of the box. If any parts are missing or damaged, contact your Highlite International dealer.

Your shipment includes:

- Infinity iFX-640
- Schuko to Neutrik powerCON cable (1,4 m)
- 2 x quick-lock brackets
- Safety cable
- User manual

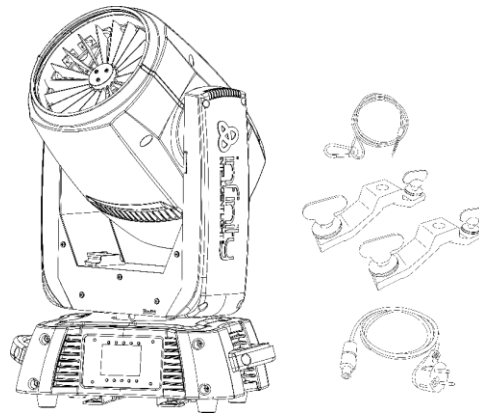

Fig. 01

1.2. Intended Use

This device is intended for professional use as a spot light moving head. It is suitable only for indoor installation. This device is not suitable for households and for general lighting.

Any other use, not mentioned under intended use, is regarded as non-intended and incorrect use.

1.3. Product Lifespan

This device is not designed for permanent operation. Disconnect the device from the electrical power supply when the device is not in operation. This will reduce the wear and will improve the device's lifespan.

1.4. LEDs Lifespan

The light output of the LEDs gradually decreases over time (lumen depreciation). High operating temperatures contribute to this process. You can extend the lifespan of the LEDs by providing adequate ventilation and operating the LEDs at the lowest possible brightness.

1.5. Text Conventions

Throughout the user manual the following text conventions are used:

- Buttons: All buttons are in bold lettering, for example "Press the **UP/DOWN** buttons"
- References: References to chapters and parts of the device are in bold lettering, for example: "Refer to **2. Safety**", "press the **beam shaper lock (05)**"
- 0–255: Defines a range of values
- Notes: **Note:** (in bold lettering) is followed by useful information or tips

1.6. Symbols and Signal Words

Safety notes and warnings are indicated throughout the user manual by safety signs.

Always follow the instructions provided in this user manual.



DANGER

Indicates an imminently hazardous situation which, if not avoided, will result in death or serious injury.



WARNING

Indicates a potentially hazardous situation which, if not avoided, could result in death or serious injury.



CAUTION

Indicates a potentially hazardous situation, which, if not avoided, may result in minor or moderate injury.



Attention

Indicates important information for the correct operation and use of the product.



Important

Read and observe the instructions in this document.



Electrical hazard



Hot surface



Eye damage hazard



Provides important information about the disposal of this product.



1.7. Symbols on the Information Label

This product is provided with an information label. The information label is located at the backside of the device.

The information label contains the following symbols:



This device is designed for indoor use.



This device shall not be treated as household waste.

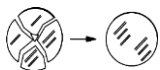

Replace any cracked protective shield.

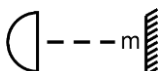

Minimum distance from lighted objects.

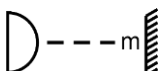

Minimum distance from other objects.



Caution: Risk of electric shock. Disconnect input power before opening.
Warning: This appliance must be earthed.

2. Safety



Important
Read and follow the instructions in this user manual before installing, operating or servicing this product.

The manufacturer will not accept liability for any resulting damages caused by the non-observance of this manual.

2.1. Warnings and Safety Instructions



DANGER
Danger for children

For adult use only. The device must be installed beyond the reach of children.

- Do not leave various parts of the packaging (plastic bags, polystyrene foam, nails, etc.) within children's reach. Packaging material is a potential source of danger for children.



DANGER
Electric shock caused by dangerous voltage inside

There are areas within the device where dangerous touch voltage may be present.

- Do not open the device or remove any covers.
- Do not operate the device if the covers or the housing are open. Before operation, check if the housing is firmly closed and all screws are tightly fastened.
- Disconnect the device from electrical power supply before service and maintenance, and when the device is not in use.



DANGER
Electric shock caused by short-circuit

This device falls under IEC protection class I.

- Make sure that the device is electrically connected to ground (earth). Connect the device only to a socket-outlet with ground (earth) connection.
- Do not cover the ground (earth) connection.
- Do not bypass the thermostatic switch or fuses.
- Do not let the power cable come into contact with other cables. Handle the power cable and all connections with the mains with caution.
- Do not modify, bend, mechanically strain, put pressure on, pull or heat up the power cable.
- Make sure that the power cable is not crimped or damaged. Examine the power cable periodically for any defects.
- Do not immerse the device in water or other liquids. Do not install the device in a location where flooding may occur.
- Do not use the device during thunderstorms. Disconnect the device from the electrical power supply immediately.



WARNING
Risk of burns due to hot surface

The surface and the inner parts of the device can become very hot during operation.

- Do not touch the device during operation.
- Allow the device to cool down for at least 15 minutes before handling.



WARNING
Risk of epileptic shock

Strobe lighting can trigger seizures in photosensitive epilepsy. Sensitive persons should avoid looking at strobe lights.



WARNING
Possible eye damage caused by high light intensity

Possibly hazardous optical radiation emitted from this device.

- Do not look at the operating light source. May be harmful to the eye.
- Do not look at the light source with optical instruments that may concentrate the light output.
- Make sure that persons are not looking directly into the light source when the device lights up suddenly. This can happen when the device is powered or when it receives DMX signal, or when certain menu items are selected.
- Disconnect power supply before servicing.
- Wear protective goggles if looking into light source during service or maintenance.



Attention
Power supply

- Before connecting the device to the power supply, make sure that the current, voltage and frequency match the input voltage, current and frequency specified on the information label on the device.
- Make sure that the cross-sectional area of the extension cords and power cables is sufficient for the required power consumption of the device.



Attention
General safety

- Do not insert objects into the air vents.
- Do not connect the device to a dimmer pack.
- Do not switch the device on and off in short intervals. This decreases the device's life.
- Do not shake the device. Avoid brute force when installing or operating the device.
- Change the lens or the LEDs if they are visibly damaged to such an extent that their effectiveness is impaired, for example by cracks or deep scratches. Contact your Highlight International dealer for more information, as servicing can be performed only by instructed or skilled persons.
- If the device is dropped or struck, disconnect the device from the electrical power supply immediately.

- If the device is exposed to extreme temperature variations (e.g. after transportation), do not switch it on immediately. Let the device reach room temperature before switching it on, otherwise it may be damaged by the formed condensation.
- If the device fails to work properly, discontinue the use immediately.



Attention
For professional use only
This device shall be used only for the purposes it is designed for.

This device is designed to be used as a professional stage light effect. Any incorrect use may lead to hazardous situations and result in injuries and material damage.

- This device is not suitable for households and for general lighting.
- This device is not designed for permanent operation.
- This device does not contain user-serviceable parts. Unauthorized modifications to the device will render the warranty void. Such modifications may result in injuries and material damage.



Attention
Before each use, examine the device visually for any defects.

Make sure that:

- All screws used for installing the device or parts of the device are tightly fastened and are not corroded.
- The safety devices are not damaged.
- There are no deformations on housings, fixations and installation points.
- The lens is not cracked or damaged.
- The power cables are not damaged and do not show any material fatigue.



Attention
Do not expose the device to conditions that exceed the rated IP class conditions.

This device is IP20 rated. IP (Ingress Protection) 20 class provides protection against solid objects greater than 12 mm, such as fingers, and no protection against harmful ingress of water.

2.2. Requirements for the User

This product may be used by ordinary persons. Maintenance may be carried by ordinary persons. Installation and service shall be carried out only by instructed or skilled persons. Contact your Highlite International dealer for more information.

Instructed persons have been instructed and trained by a skilled person, or are supervised by a skilled person, for specific tasks and work activities associated with the installation, service and maintenance of this product, so that they can identify risks and take precautions to avoid them.

Skilled persons have training or experience, which enables them to recognize risks and to avoid hazards associated with the installation, service and maintenance of this product.

Ordinary persons are all persons other than instructed persons and skilled persons. Ordinary persons include not only users of the product but also any other persons that may have access to the device or who may be in the vicinity of the device.

3. Description of the Device

The Infinity iFX-640 is a 6 x 40 watt RGBW effect Moving Head with Individual Pixel Control. This creative eye-candy lighting fixture is perfectly fit to create stunning effects with its 4 dimmer curves, continuously bi-rotating front lens, circular prism (flower effect) and strobe function.

With the iFX-640 you can create nice colours, from punchy saturates to smooth pastels and whites. It's also possible to seamlessly transition from a narrow 5° beam to a wide 36° wash due to its motorized zoom. Finally, you can control the diffraction blades steplessly. This enables you to create a wash effect with a soft edge that is precisely tailored to your scene. Controlling this fixture can be done manually and via DMX in either Manual and Auto-Run mode.

3.1. Front View

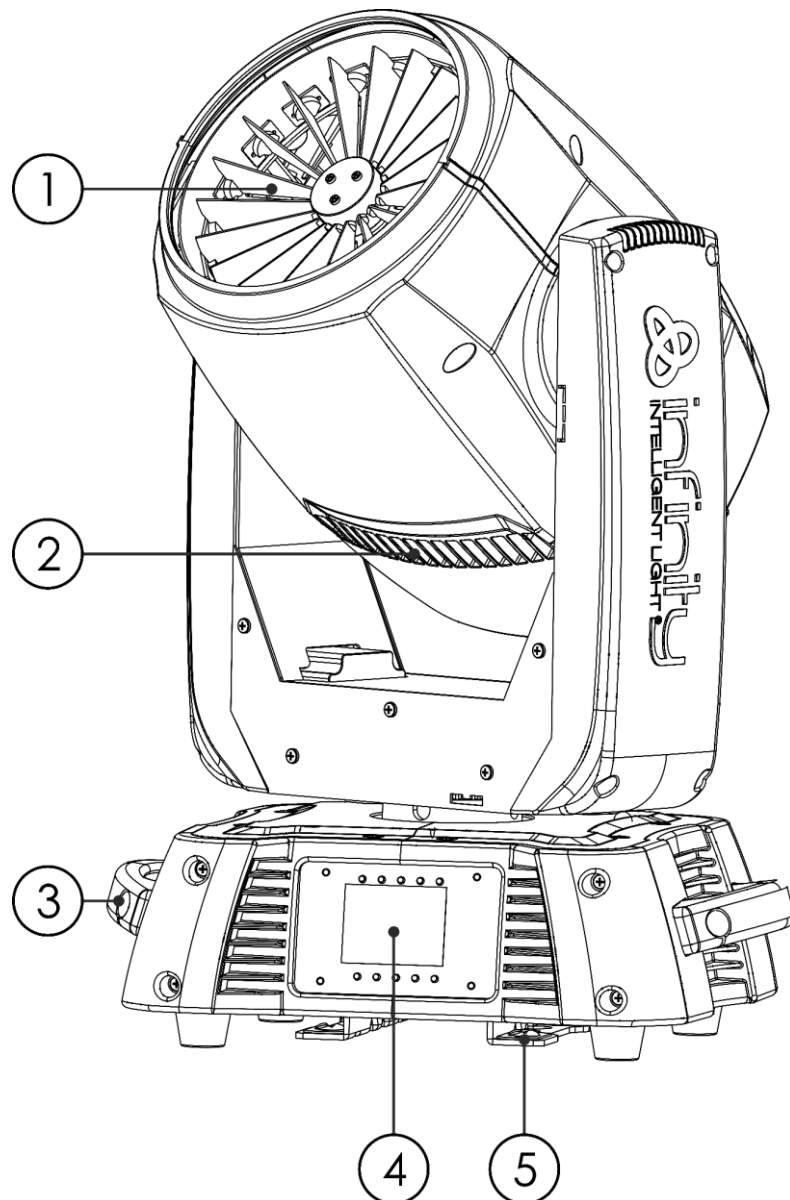

Fig. 02

- 01) 6x 40 W RGBW LEDs
- 02) Air vents
- 03) 2 x transport handles
- 04) Control panel: LCD display and control buttons
- 05) Mounting brackets

3.2. Back View

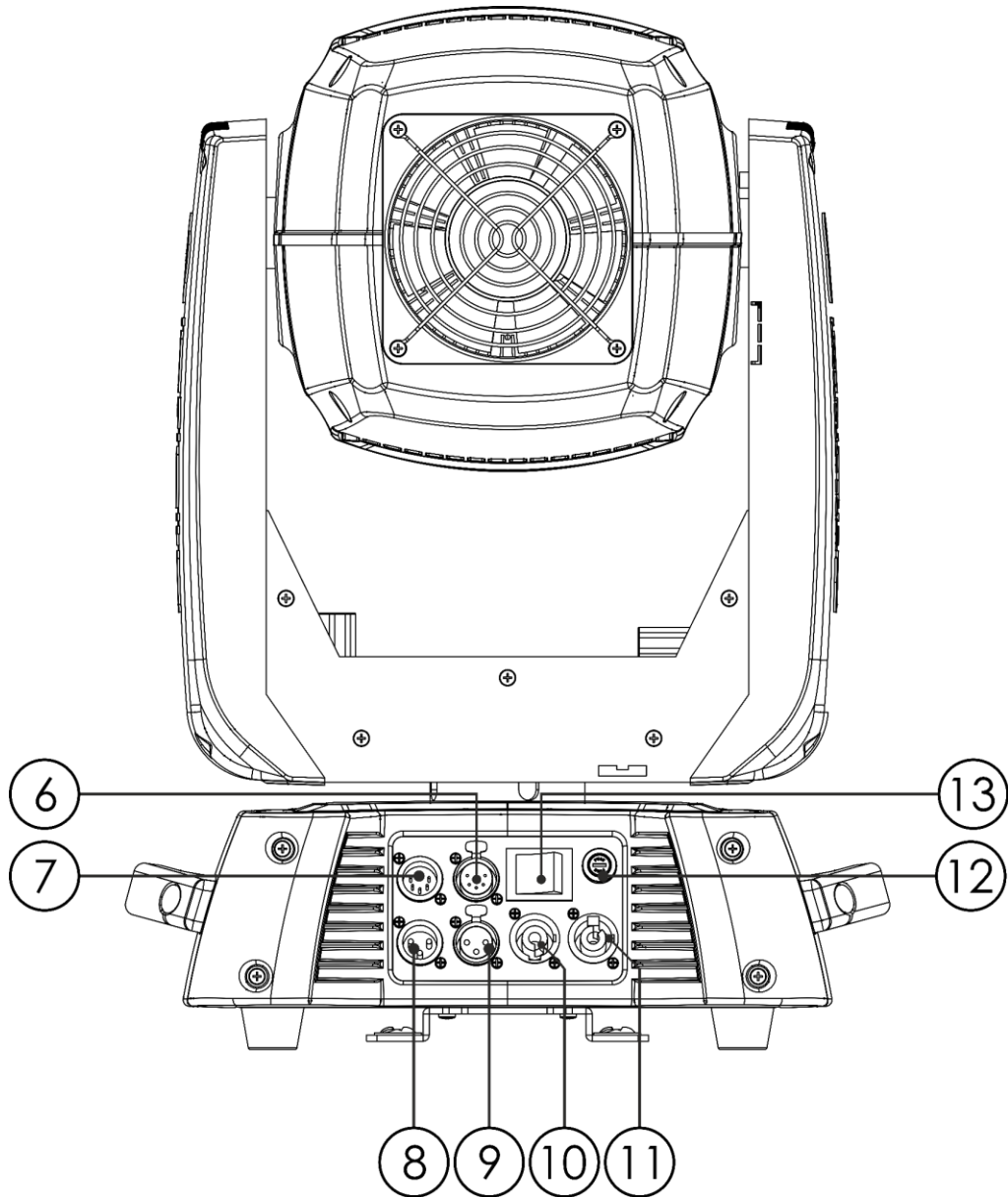
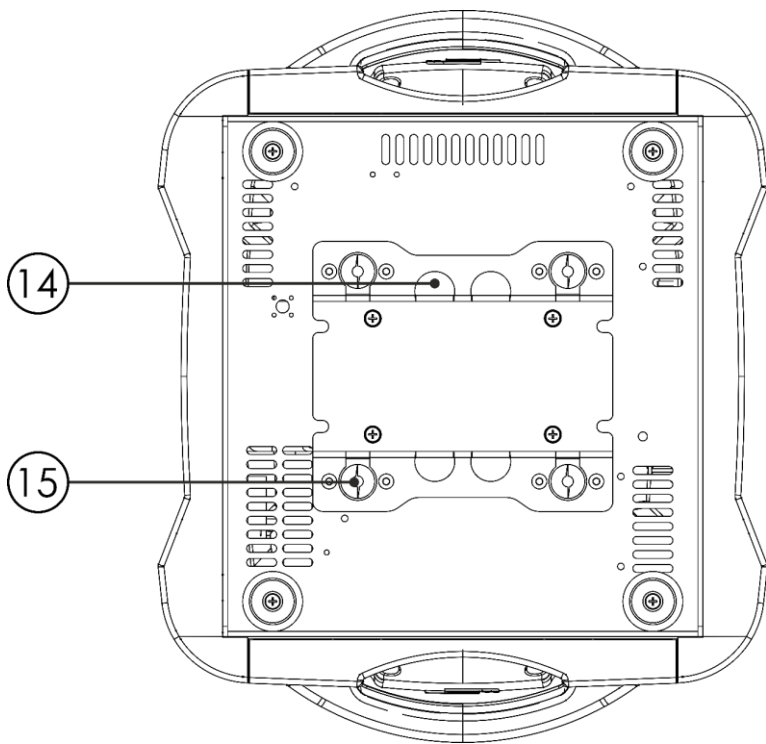

Fig. 03

- 06) 5-pin DMX signal connector OUT
- 07) 5-pin DMX signal connector IN
- 08) 3-pin DMX signal connector IN
- 09) 3-pin DMX signal connector OUT
- 10) Neutrik powerCON connector IN (Blue)
- 11) Neutrik powerCON connector OUT (Gray)
- 12) Fuse F7AL/250 V
- 13) ON/OFF

3.3. Base Plate



- 14) Safety eye
- 15) 4 x mounting holes for quick-lock brackets

Fig. 04

3.4. Product Specifications

Model:	iFX-640
Electrical:	
Input voltage:	100–240 V AC, 50/60 Hz
Power consumption:	360 W (max)
Fuse:	F7AL/250 V
Physical:	
Dimensions:	366 x 304 x 536 mm (L x W x H)
Weight:	14,56 kg
Movement:	
Pan adjustment:	0°-540°
Tilt adjustment:	0°-270°
Optics:	
Light source:	6x 40 W RGBW LEDs
Dimmer:	0–100 %
Strobe:	0–20 Hz
Beam angle:	5°–36° circular max.
Luminous flux:	1800 lm
Color temperature:	2700–19000 K
Effects:	6 x O-star RGBW LED Moving Head Continuously bi-rotating front lens Beam diffraction blades Individual Pixel Control (6 sections) Flower effect
Operation and control:	
Control:	DMX-512, RDM, manual
DMX channels:	24, 53, 59, 86 channels
Control panel:	LCD display, control buttons
Connections:	
Power connections:	Neutrik powerCON connectors IN/OUT
Data connections:	3 + 5-pin DMX connectors IN/OUT
Signal pinouts:	Pin 1 (ground), pin 2 (-), pin 3 (+), pin 4 (N/C), pin 5 (N/C) Pin 1 (earth), pin 2 (-), pin 3 (+)
Construction:	
Housing:	Machined aluminum, sheet metal, molded engineering grade plastics
Color:	Black
IP rating:	IP20
Cooling:	Internal fan (Silent, Auto, and Full modes)
Thermal:	
Maximum ambient temperature t_a :	40 °C
Maximum housing temperature t_c :	70 °C
Minimum distance:	
Minimum distance from flammable surfaces:	0,8 m
Minimum distance to lighted object:	0,8 m

3.5. Dimensions

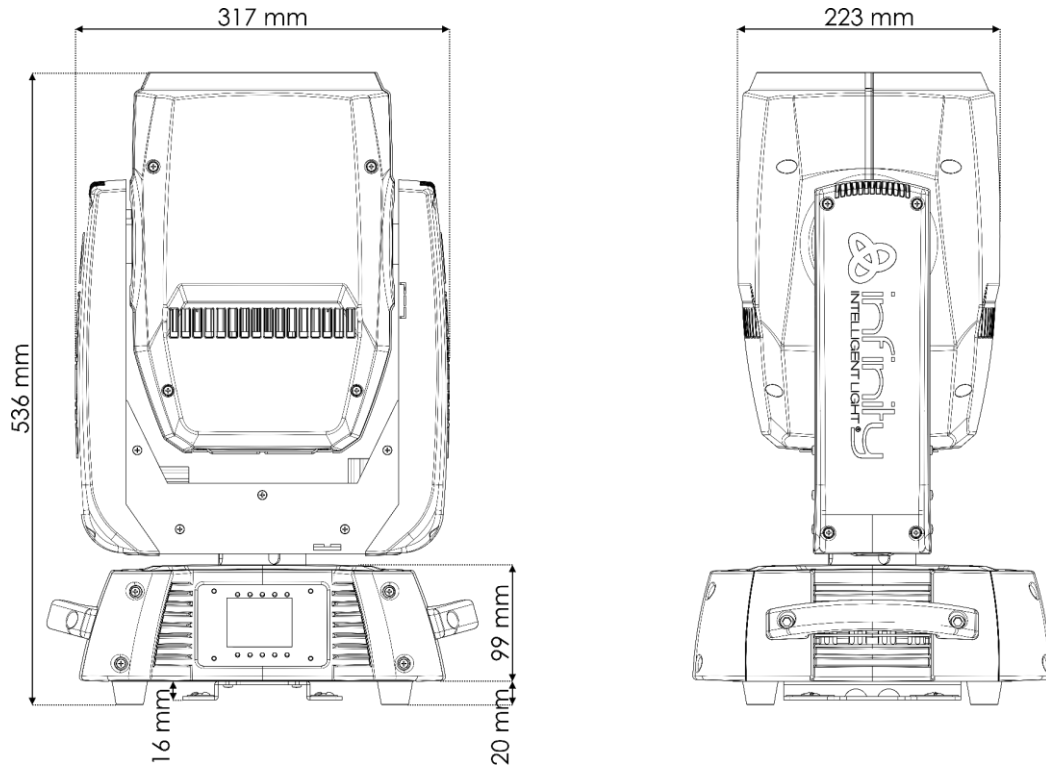

Fig. 05

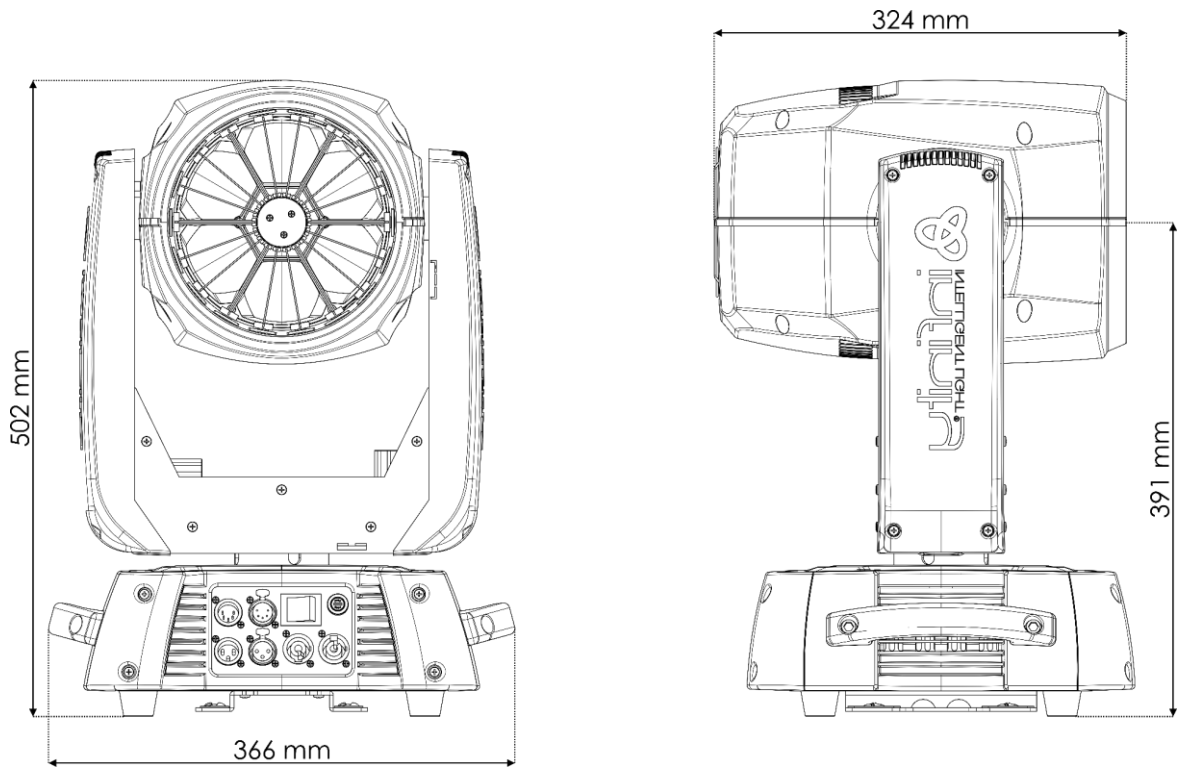

Fig. 06

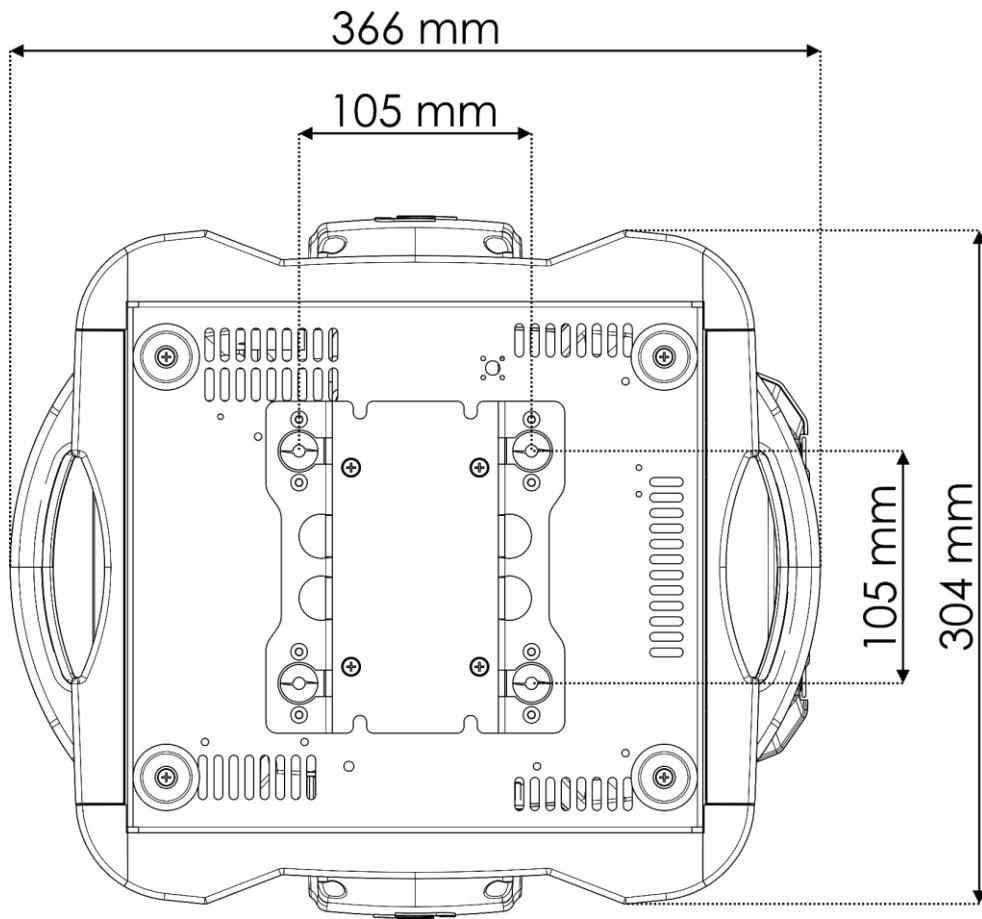

Fig. 07

4. Installation

4.1. Safety Instructions for Installation



WARNING

Incorrect installation can cause serious injuries and damage of property.

If trussing systems are used, installation must be carried out only by instructed or skilled persons.

Follow all applicable European, national and local safety regulations concerning rigging and trussing.

4.2. Personal Protective Equipment

During installation and rigging wear personal protective equipment in compliance with the national and site-specific regulations.

4.3. Installation Site Requirements

- The device can be used only indoors.
- The device can be mounted to a truss or another rigging structure in any orientation.
- The device can be placed on flat surface.
- The minimum distance to other objects must be bigger than 0,8 m.
- The maximum ambient temperature $t_a = 40\text{ °C}$ must never be exceeded.
- The relative humidity must not exceed 50 % with an ambient temperature of 40 °C.

4.4. Rigging

The device can be positioned on a flat surface or mounted to a truss or other rigging structure in any orientation. Make sure that all loads are within the pre-determined limits of the supporting structure.



CAUTION

Restrict the access under the work area during rigging and/or derigging.

To mount the device, follow the steps below:

- 01) Fasten the 2 quick lock brackets, supplied with the device, on the **mounting holes for quick lock brackets (15)**.
- 02) Install the clamps, as shown in Fig. 08. Make sure that you use clamps suitable for attaching the device to a truss.

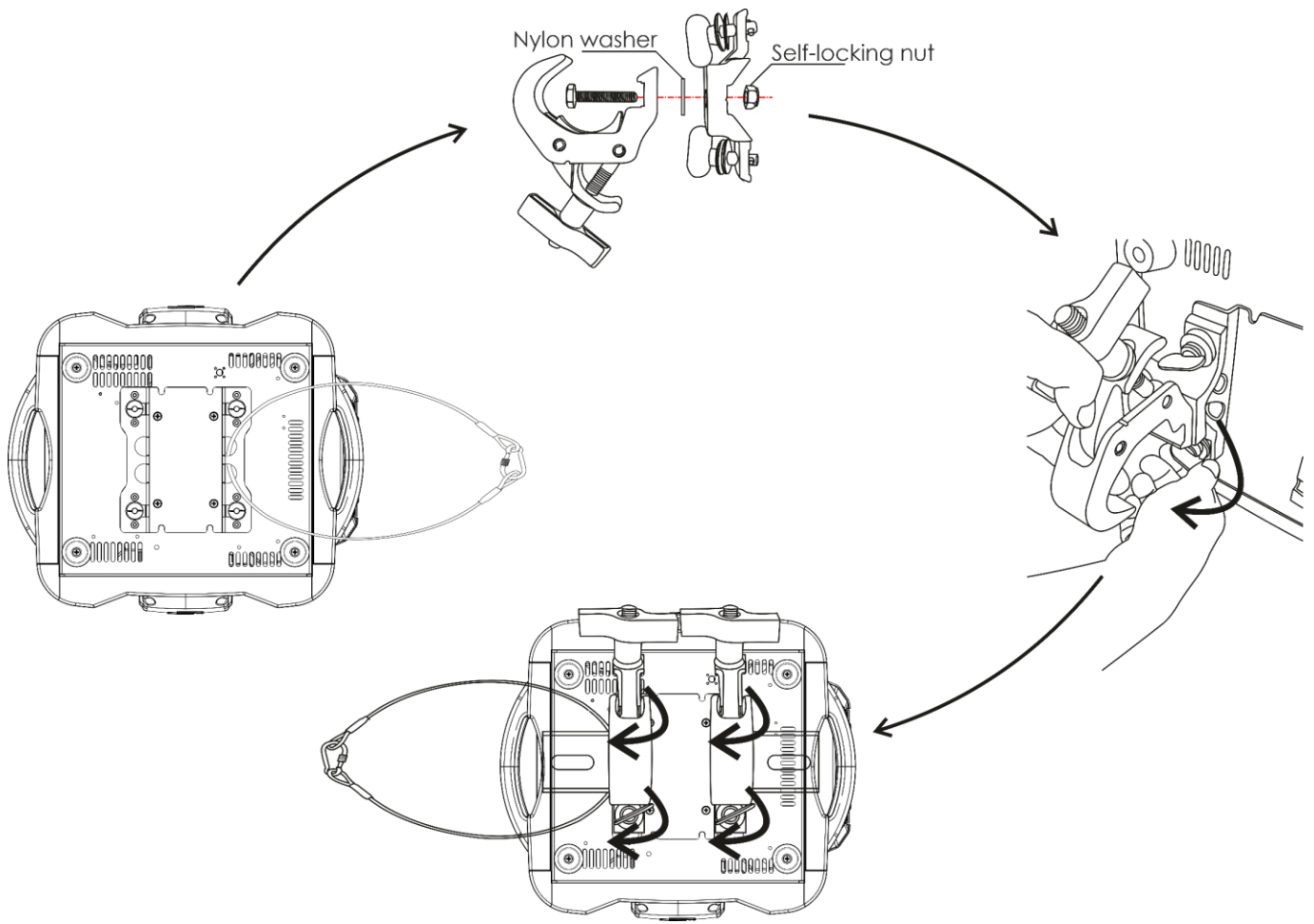

Fig. 08

- 03) Attach the device to the supporting structure. Make sure that the device cannot move freely.
- 04) Secure the device with a secondary suspension, for example a safety cable. Make sure that the secondary suspension can hold 10 times the weight of the device. If possible, the secondary suspension should be attached to a supporting structure independent of the primary suspension. Put the safety cable through the **safety eye (14)**, as shown in Fig. 08.

4.5. Connecting to Power Supply



DANGER
Electric shock caused by short-circuit

The device accepts AC mains power at 100–240 V and 50/60 Hz. Do not supply power at any other voltage or frequency to the device.

This device falls under IEC protection class I. Make sure that the device is always electrically connected to the ground (earth).

Before connecting the device to the socket-outlet:

- Make sure that the power supply matches the input voltage specified on the information label on the device.
- Make sure that the socket-outlet has ground (earth) connection.

Connect the device to the socket-outlet with the power plug. Do not connect the device to a dimmer circuit, as this may damage the device.

4.6. Power Linking of Multiple Devices

This device supports power linking. Power can be relayed to another device via the power OUT connector. Note that the input and the output connectors have different designs: one type cannot be connected to the other.

Power linking of multiple devices must be carried out only by instructed or skilled persons.



WARNING
Incorrect power linking may lead to overload of the electrical circuit and result in serious injuries and damage of property.

To prevent overload of the electrical circuit, when power linking multiple devices:

- Use cables with sufficient current-carrying capacity. The power cable supplied with the device is not suitable for power linking of multiple devices.
- Make sure that the total current draw of the device and all connected devices does not exceed the rated capacity of the power cables and the circuit breaker.
- Do not link more devices on one power link than the maximum recommended number.

Maximum recommended number of devices:

- at 100–120 V: 4 devices iFX-640
- at 200–240 V: 8 devices iFX-640

5. Setup

5.1. Warnings and Precautions



Attention

Connect all data cables before supplying power.

Disconnect power supply before connecting or disconnecting data cables.

5.2. Stand-alone Setup

When the iFX-640 is not connected to a DMX controller, it functions as a stand-alone device in manual control mode.

For more information about the control modes, refer to **6.2. Control Modes** on page 21.

5.3. DMX Connection

5.3.1. DMX-512 Protocol

You need a DMX serial data link to run light shows of one or more devices using a DMX-512 controller.

The iFX-640 has 3-pin and 5-pin DMX signal IN and OUT connectors.

The pin assignment is as follows:

- 3-pin: pin 1 (ground), pin 2 (-), pin 3 (+)
- 5-pin: pin 1 (ground), pin 2 (-), pin 3 (+), pin 4 (N/C), pin 5 (N/C)

Devices on a serial data link must be daisy-chained in a single line. The number of devices that you can control on one data link is limited by the combined number of the DMX channels of the connected devices and the 512 channels available in one DMX universe.

To comply with the TIA-485 standard, no more than 32 devices should be connected on one data link. In order to connect more than 32 devices on one data link, you must use a DMX optically isolated splitter/booster, otherwise this may result in deterioration of the DMX signal.

Note:

- Maximum recommended DMX data link distance: 300 m
- Maximum recommended number of devices on a DMX data link: 32 devices

5.3.2. DMX Cables

Shielded twisted-pair cables with 3-pin/5-pin XLR connectors must be used for reliable DMX connection. You can purchase DMX cables directly from your Highlite International dealer or make your own cables.

If you use XLR audio cables for DMX data transmission, this may lead to signal degradation and unreliable operation of the DMX network.

When you make your own DMX cables, make sure that you connect the pins and wires correctly as shown in Fig. 14.

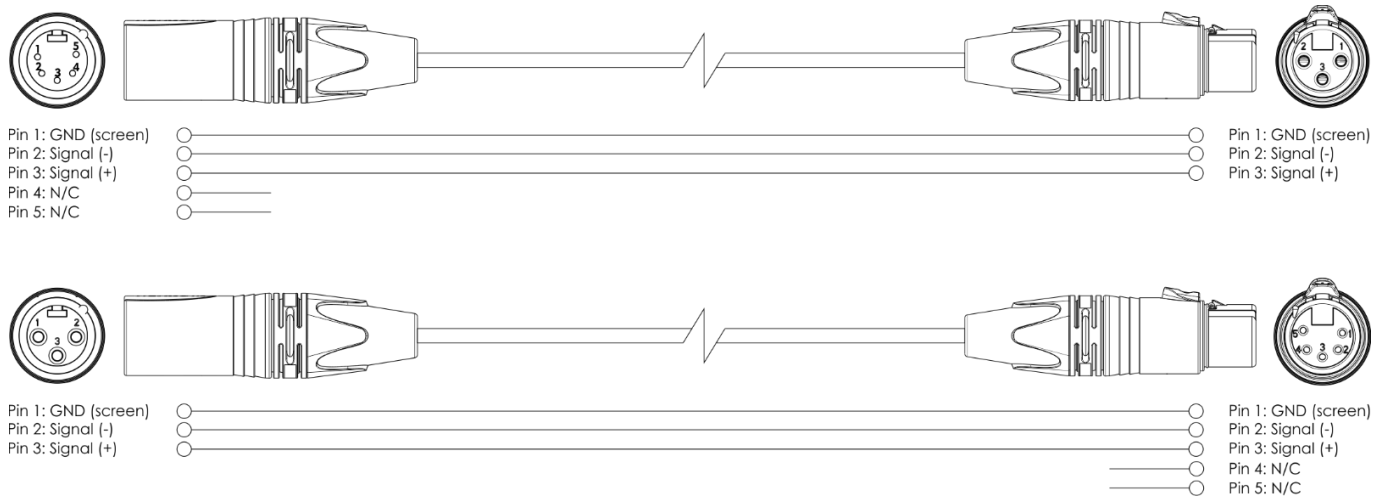

Fig. 14

5.3.3. Master/Slave Setup

The iFX-640 supports master/slave control mode. To connect multiple devices in master/slave setup, follow the steps below:

- 05) Connect the first device's DMX OUT connector to the second device's DMX IN connector.
- 06) Repeat step 1 to connect all devices as shown in Fig. 09. The first connected device will be automatically recognized as the master device.
- 07) Set all subsequent devices as slave devices. See **6.6.2. DMX Channel Mode** on page 25 for more information.
- 08) Connect a DMX terminator (120 Ω resistor) to the DMX OUT connector of the last device in the setup.

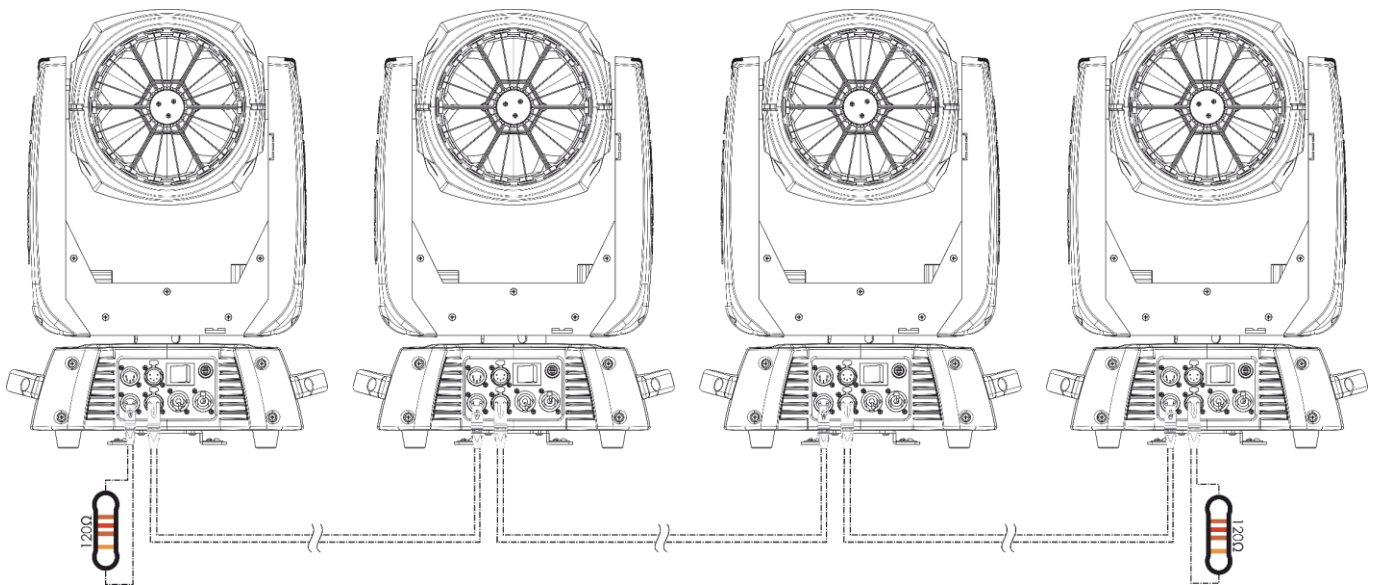

Fig. 09

5.3.4. DMX Linking

To connect multiple devices on one DMX data link, follow the steps below:

- 01) Use a 3-pin/5-pin DMX cable to connect the DMX OUT connector of the lighting controller to the DMX IN connector of the first device.
- 02) Connect the first device's DMX OUT connector to the second device's DMX IN connector with a 3-pin/5-pin DMX cable.
- 03) Repeat step 2 to connect all devices in a daisy-chain as shown in Fig. 15.
- 04) Connect a DMX terminator (120 Ω resistor) to the DMX OUT connector of the last device on the data link.

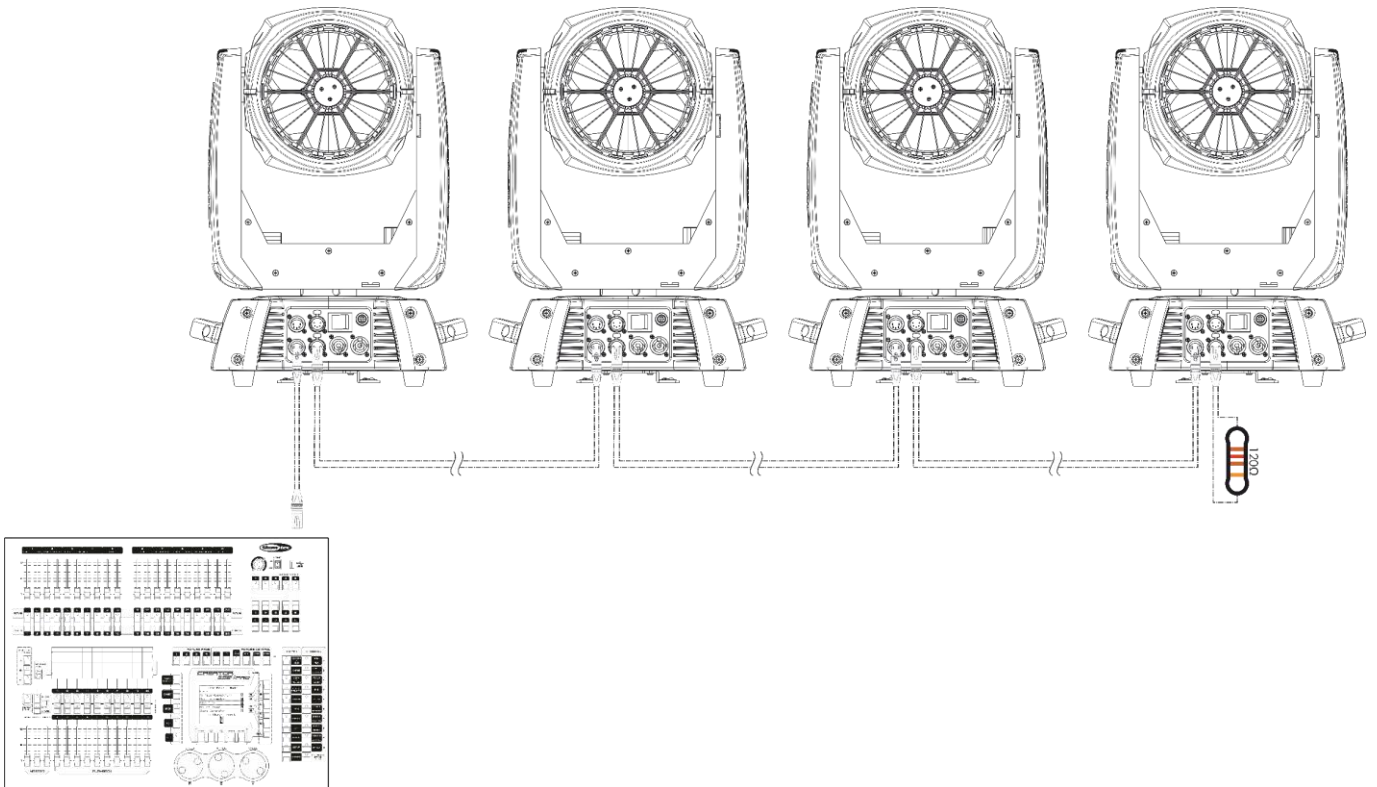

Fig. 15

5.3.5. DMX Addressing

In a setup with multiple devices, make sure that you set the DMX starting address of each device correctly. The iFX-640 has 4 DMX channel modes: 24, 53, 59 and 86 channels.

If you want to connect multiple devices on one data link and use them in 86-channel mode, for example, follow the steps below:

- 05) Set the starting address of the 1st device on the data link to 1 (001).
- 06) Set the starting address of the 2nd device on the data link to 87 (087), as $1 + 86 = 87$.
- 07) Set the starting address of the 3rd device on the data link to 173 (173), as $87 + 86 = 173$.
- 08) Continue assigning the starting addresses of the remaining devices by adding each time 86 to the previous number.

Make sure that you do not have any overlapping channels in order to control each iFX-640 correctly. If two or more devices are addressed similarly, they will work similarly.

6. Operation

6.1. Safety Instructions for Operation



Attention

This device must be used only for the purposes it is designed for.

This device is intended for professional use as a spot light moving head. It is suitable only for indoor installation. This device is not suitable for households and for general lighting.

Any other use, not mentioned under intended use, is regarded as non-intended and incorrect use.



Attention

Power supply

Before connecting the device to the power supply, make sure that the current, voltage and frequency match the input voltage, current and frequency specified on the information label on the device.

6.2. Control Modes

The iFX-640 can be operated with a DMX controller and as a stand-alone device.

The iFX-640 supports the following control modes:

- Stand-alone: Manual/Auto operation mode (auto programs)
- Master/Slave: Auto operation mode (auto programs)
- DMX-512: 24, 53, 59, 86 channels

For more information about how to connect the devices, refer to **5. Setup** on pages 18–20.

To run the built-in programs in auto operation mode without a DMX controller, activate Built-in menu. See **6.6.6. Built-in Programs** on page 28 for more information.

To operate the device in a master/slave setup, adjust the settings in Edit Mode menu. See **6.6.2. DMX Channel Mode** on page 25 for more information.

To operate the device with a DMX controller:

- 01) Set the DMX starting address of the device in the DMX Address submenu. See **5.3.5. DMX Addressing** on page 20 and **6.6.1. DMX Address** on page 24.
- 02) Select the DMX channel mode. See **6.6.2. DMX Channel Mode** on page 25 for more information. See **6.7. DMX Channels** on pages 31–44 for complete overview of all DMX channels.

6.3. Control Panel

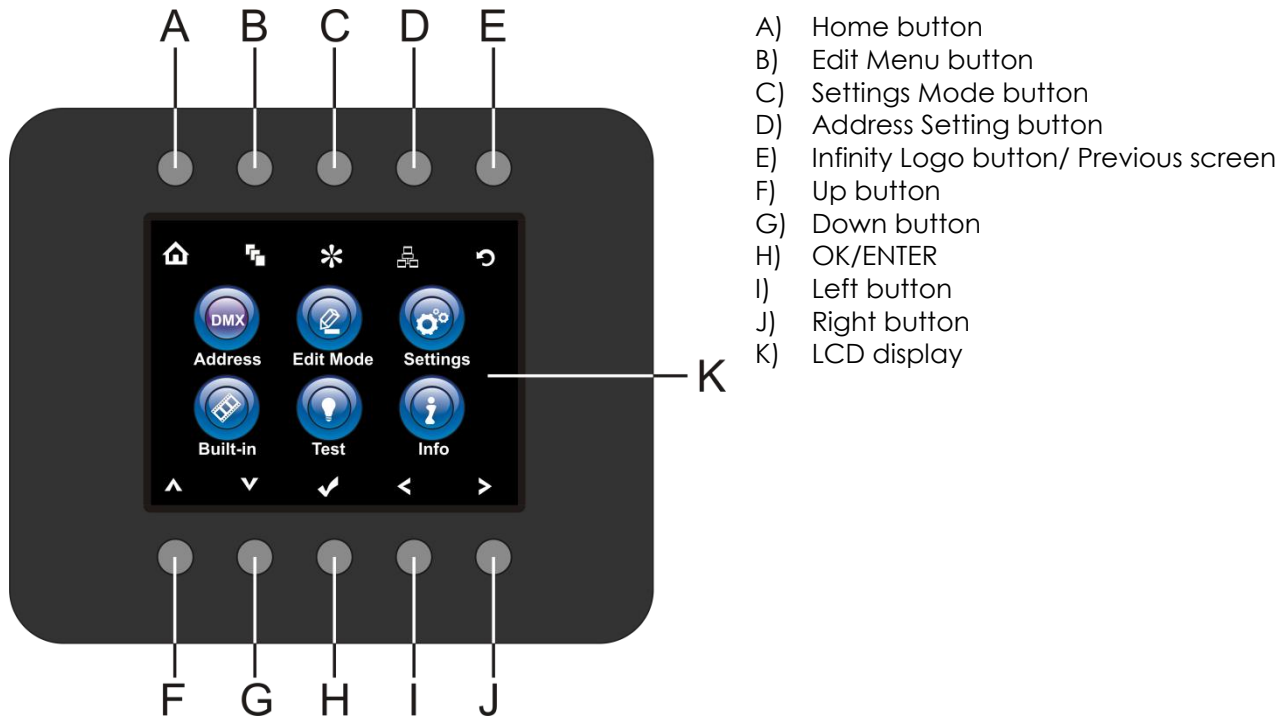

Fig. 16

- Press the **INFINITY LOGO BUTTON/ PREVIOUS SCREEN** button once to exit the current submenu and to return to the start screen. Press the **INFINITY LOGO BUTTON/ PREVIOUS SCREEN** button once again to return to the current submenu.
- Use the **UP/DOWN** buttons to navigate through the menus or to increase/decrease numeric values.
- Use the **LEFT/RIGHT** buttons to navigate through the menus
- Use the **OK/ENTER** button to open the desired menu, to confirm your choice or to set the currently selected value.

6.4. Start-up

Upon start-up the device will start initializing for 45 seconds.

Immediately afterwards the display will show the start screen. The start screen provides information about the control mode, the DMX channel mode, the DMX starting address of the device and the temperature of the LEDs, for example:

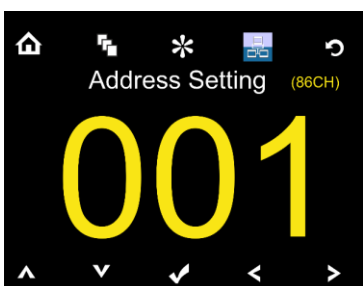

Note: If no button is pressed, after 20 seconds of inactivity the display will return to the start screen and after 10 more seconds it will turn off. Press any button to turn the display on.

6.5. Menu Overview

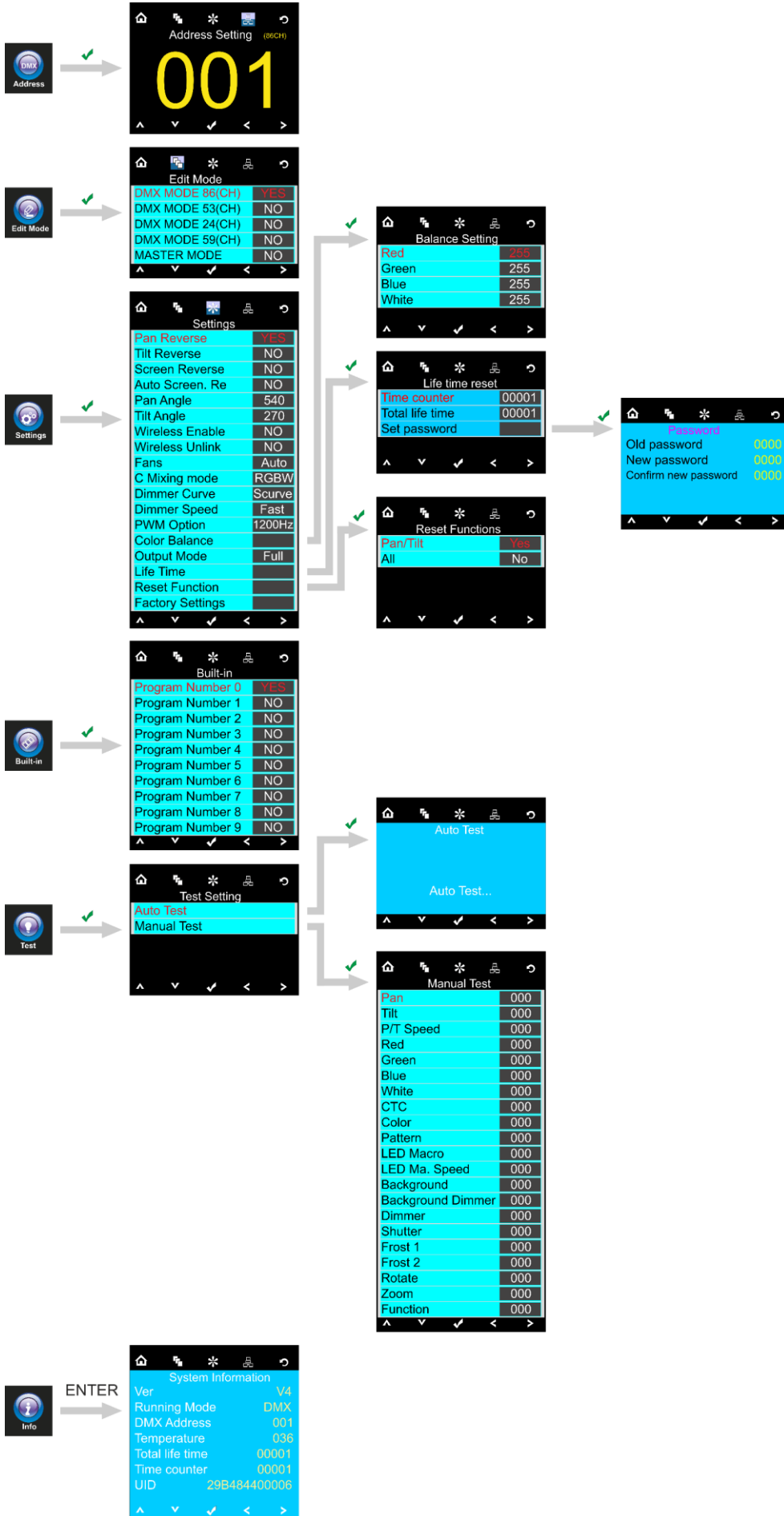

6.6. Main Menu Options

The main menu has the following options:



DMX address



Edit Mode



Settings Menu



Built-in Programs

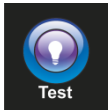

Test Mode



Info



Home



Up



Edit Menu



Down



Settings Mode



OK/Enter



Address Setting



Left



Previous screen/Infinity Logo



Right

01) Turn the **CONTROL** wheel to navigate through the main menu.

01) Press the **CONTROL** wheel to open the submenus.

6.6.1. DMX Address

In this menu you can set the starting DMX address of the device.

01) Press the  button.

02) Press the  button, to confirm. You can choose 512 different DMX addresses.

03) Press the     buttons to select the required address from **001** ^{Up/Down} **512**.

04) Once you have set the desired DMX address, press the  button to store your DMX address.



6.6.2. DMX Channel Mode

With this menu you can set your desired DMX personality and running mode.

01) Press the  button and select  .

02) Press the  button, to confirm. You can choose between 5 submenus.



03) Press the   buttons to select the desired DMX channels.

04) Press the  button, to confirm.

05) Once you have selected the desired DMX channels, press the   buttons to change the value from NO to YES.

06) Once you have selected the desired setting, press the  button to store your settings.





07) If you have chosen Master Mode, press the   buttons to change the value from NO to YES.

08) If you choose NO in MASTER MODE the device will react as slave, it will react the same as its master device.



09) If you choose YES in MASTER MODE the device will react as the master, all other devices will react as a slave device.

6.6.3. Settings Menu

With this menu you can set your desired settings.

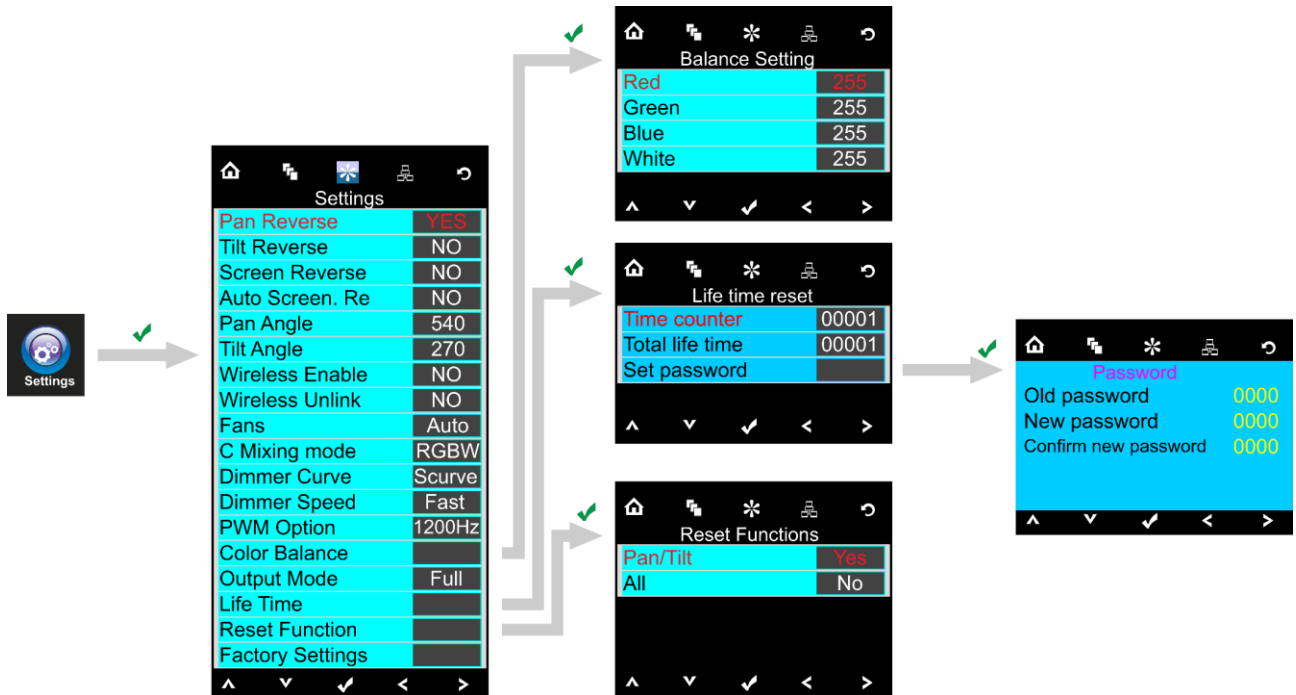





- 01) Press the  button and select .
- 02) Press the  button, to confirm. You can choose from 18 different modes.
- 03) Press the   buttons to select the required mode:



- 04) Once you have selected the desired mode, press the  button to proceed to edition.
- 05) Press the   buttons to change the value from NO to YES.
- 06) Some of the available menus have different options to the regular, YES or NO function:
 - Pan Angle: 540°, 360°, 180°
 - Tilt Angle: 270°, 180°, 90°
 - Fans: Auto, Silent, Full
 - C Mixing Mode: RGBW, CMY
 - Dimmer Curve: Linear, Square, I Squa, SCurve
 - Dimmer Speed: Smooth, Fast
 - PWM Option: 600Hz, 1200Hz, 2000Hz, 4000Hz, 6000Hz, 15000Hz
 - Output Mode: White, Full









6.6.3.1. Color Balance

With this menu you can set the device's color brightness.

- 01) Press the   buttons to select Color Balance and press the  button to open the menu.
- 02) You can now adjust 4 colors: Red, Green, Blue, White.
- 03) Choose the desired color, press the  button and then press the   buttons to set the value. The adjustment range is between 0-255, from dark to brightest.
- 04) You can combine Red, Green, Blue and White to create an infinite range of colors.

6.6.3.2. Life Time

With this menu you can reset the device's counters.





- 01) Press the   buttons to select Life Time and press the  button to open the menu.
- 02) Press the   buttons to choose one of the 3 reset options:
 - Time Counter (the time counter will be reset)
 - Total Life Time (the device's operation time counter will be reset)
 - Set Password
- 03) If you select Time Counter or Total Life Time, press the  button to open the selection menu.
- 04) Press the   buttons to choose either YES or NO. Press the  button to confirm.

6.6.3.3. Set Password

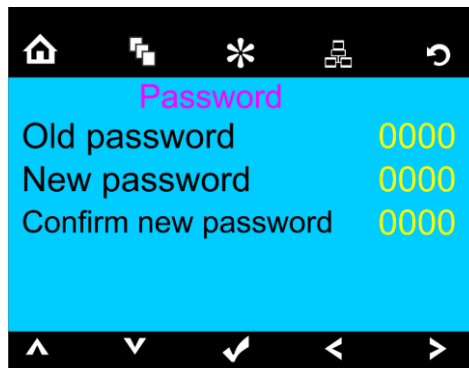



With this menu you can set the new password for the device.

- 01) Press the   buttons to select Set Password and press the  button to open the menu.
- 02) The following screen will pop up:











- 03) Press the   buttons to select the digit which you want to edit.
- 04) Press the   buttons to adjust the values.

6.6.4. Settings Menu

- 01) If you have chosen the desired option, press the  button to proceed to edition mode.
- 02) Press the   buttons to adjust the options.
- 03) Press the  button to confirm your choice.

6.6.5. Reset Functions

With this menu you can reset the device.



- 01) Press the   buttons to select Reset Functions and press the  button to open the menu.
- 02) Press the   buttons to choose one of the 3 reset options:
- Pan/Tilt
 - Zoom
 - All
- 03) Press the   buttons to choose either YES or NO. Press the  button to confirm.
- 04) Once you have selected the desired setting, press the  button to store your settings.

6.6.6. Built-in Programs

With this menu you can choose your desired built-in program.

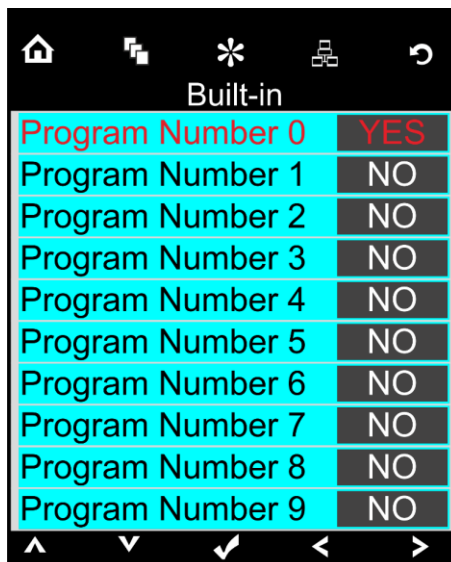
- 01) Press the  button and select .
- 02) Press the  button, to confirm. You can choose 10 different built-in programs.



- 03) Press the Up / Down buttons to select the required program:
- 04) Once you have selected the desired built-in program, press the   buttons to change the value from NO to YES.
- 05) Once you have selected the desired setting, press the  button to store your settings.
- 06) If you have chosen YES the desired built-in program will start automatically.

6.6.7. Test Menu

With this menu you can test the device automatic or manual.

01) Press the  button and select .

02) Press the  button, to confirm. You can choose 2 different test modes.

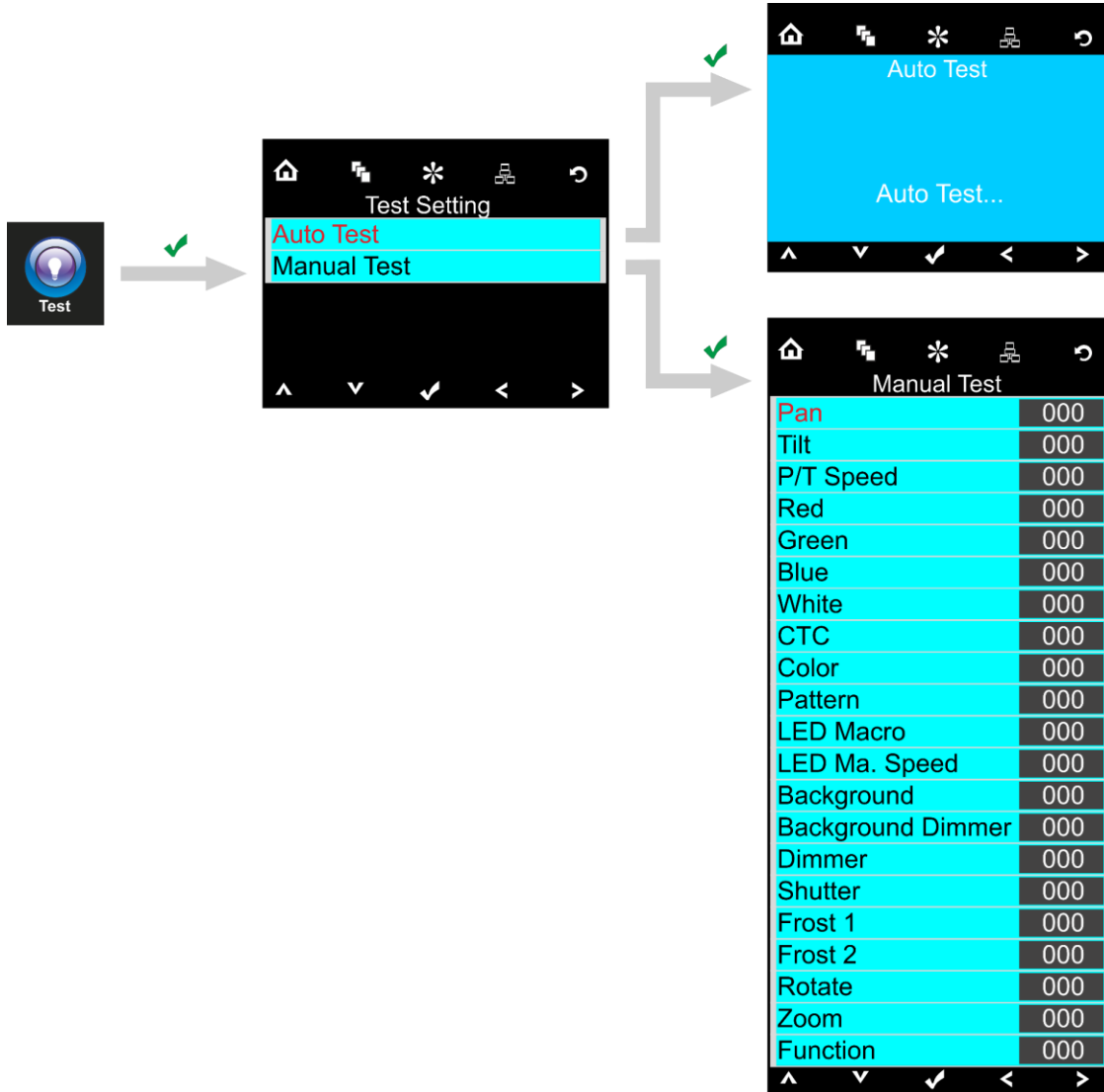



03) Press the   buttons to select the required test mode.



04) Press the  button, to confirm.

05) If you have chosen AUTO TEST the device will automatically start its auto test program.

06) If you have chosen MANUAL TEST you will enter a submenu. You can choose between 21 test options: Pan, Tilt, P/T Speed, Red, Green, Blue, White, CTC, Color, Pattern, LED Macro, LED Macro Speed, Background, Background Dimmer, Dimmer, Shutter, Frost 1, Frost 2, Rotate, Zoom, Function.

07) Press the   buttons to select the required test option.

08) Press the  button, to confirm.

09) Once you have selected the desired option, press the   buttons to change the value from 000 to 255.

10) Once you have set the desired option, press the  button to store your settings.

6.6.8. Information Menu

With this menu you can see several device settings.

01) Press the  button and select .

02) Press the  button, to confirm.

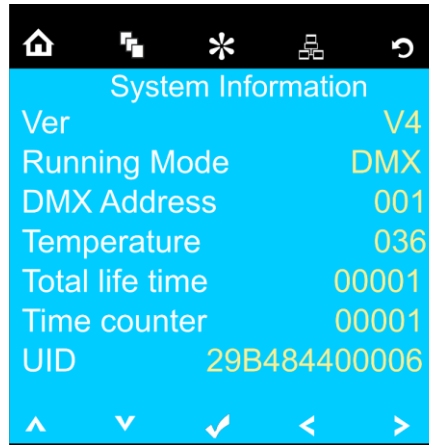

03) You can view 7 parameters.

6.7. DMX Channels

6.7.1. DMX Channels Overview

Function	24 channels	53 channels	59 channels	86 channels
Pan	1	1	1	1
Tilt	2	2	2	2
Pan 16-bit	3	3	3	3
Tilt 16-bit	4	4	4	4
Pan/Tilt Speed	5	5	5	5
Dimmer	6	6	6	6
Dimmer Fine		7	7	7
Shutter/Strobe	7	8	8	8
CTC	8	9	9	9
Color	9	10	10	10
Pattern	10	11	11	11
LED Built-in	11	12	12	12
LED Built-in Speed	12	13	13	13
LED Built-in Delay	13	14	14	14
Background Color	14	15	15	15
Background Color Dimmer	15	16	16	16
Background Color Dimmer 16-bit				17
Background R		17	17	18
Background R 16-bit				19
Background G		18	18	20
Background G 16-bit				21
Background B		19	19	22
Background B 16-bit				23
Background W		20	20	24
Background W 16-bit				25
Frost (fan blade)	16	21	21	26
Lens rotating	17	22	22	27
Frost (light guide)	18	23	23	28
Zoom	19	24	24	29
Control	20	25	25	30
Red main	21	26	26	31
Red main 16-bit				32
Green main	22	27	27	33
Green main 16-bit				34
Blue main	23	28	28	35
Blue main 16-bit				36
White main	24	29	29	37
White main 16-bit				38
Dimmer 1			30	
R1 (C)		30	31	39
R1 (C) 16-bit				40
G1 (M)		31	32	41
G1 (M) 16-bit				42
B1 (Y)		32	33	43
B1 (Y) 16-bit				44
W1		33	34	45
W1 16-bit				46
Dimmer 2			35	
R2 (C)		34	36	47
R2 (C) 16-bit				48
G2 (M)		35	37	49
G2 (M) 16-bit				50

B2 (Y)		36	38	51
B2 (Y) 16-bit				52
W2		37	39	53
W2 16-bit				54
Dimmer 3			40	
R3 (C)		38	41	55
R3 (C) 16-bit				56
G3 (M)		39	42	57
G3 (M) 16-bit				58
B3 (Y)		40	43	59
B3 (Y) 16-bit				60
W3		41	44	61
W3 16-bit				62
Dimmer 4			45	
R4 (C)		42	46	63
R4 (C) 16-bit				64
G4 (M)		43	47	65
G4 (M) 16-bit				66
B4 (Y)		44	48	67
B4 (Y) 16-bit				68
W4		45	49	69
W4 16-bit				70
Dimmer 5			50	
R5 (C)		46	51	71
R5 (C) 16-bit				72
G5 (M)		47	52	73
G5 (M) 16-bit				74
B5 (Y)		48	53	75
B5 (Y) 16-bit				76
W5		49	54	77
W5 16-bit				78
Dimmer 6			55	
R6 (C)		50	56	79
R6 (C) 16-bit				80
G6 (M)		51	57	81
G6 (M) 16-bit				82
B6 (Y)		52	58	83
B6 (Y) 16-bit				84
W6		53	59	85
W6 16-bit				86

Note: Make sure that the Master Dimmer channel and the Shutter/Strobe channel are open in order to see the light output.

6.7.2. 24 channels, 86 channels

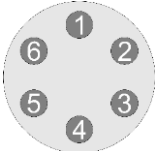
24 CH	86 CH	Function	Value	Setting
1	1	Pan	000–255	Pan adjustment 0°–540°
2	2	Tilt	000–255	Tilt adjustment 0°–270°
3	3	Pan, Fine	000–255	Pan adjustment, 16-bit
4	4	Tilt, Fine	000–255	Tilt adjustment, 16-bit
5	5	Pan/Tilt speed	000–255	Speed adjustment of the pan/tilt, from fast to slow
6	6	Master Dimmer	000–255	From low to high intensity (0–100 %)
	7	Master Dimmer Fine	000–255	From low to high intensity (0–100 %)
7	8	Shutter/Strobe	000–019	Off
			020–024	On
			025–064	Strobe 1 with decreasing speed
			065–084	Strobe 2(fast on slow off) with decreasing speed
			085–104	Strobe 3(slw on fast off) with decreasing speed
			105–124	Strobe 4(random strobe) with decreasing speed
			125–144	Strobe 5(random fast on slow off)with decreasing speed
			145–164	Strobe 6(random slow on fast off) with decreasing speed
			165–184	Strobe 7(pulse strobe) with decreasing speed
			185–204	Strobe 8(random pulse strobe) with decreasing speed
			205–224	Strobe 9(fade on or off) with decreasing speed
			225–244	Strobe 10(pulse strobe) with decreasing speed
			245–255	on
8	9	CTC	000	No function
			001–255	From 19000K to 2700K
9	10	Color	000	No function
			001–002	White 2700K(R=156, G=118, B=0, W=63)
			003–004	White 3200K(R=156, G=141, B=5, W=89)
			005–006	White 4200K(R=156, G=141, B=14, W=255)
			007–008	White 5600K(R=156, G=207, B=54, W=255)
			009–010	White 8000K(R=130, G=255, B=96, W=255)
			011	Blue (R=0, G=0, B=255, W=0)
			012–048	R=0, G+, B=255, W=0
			49	Cyan (R=0, G=255, B=255, W=0)
			050–086	R=0, G=255, B-, W=0
			87	Green (R=0, G=255, B=0, W=0)
			088–124	R+, G=255, B=0, W=0
			125	Yellow (R=255, G=255, B=0, W=0)
			126–162	R=255, G-, B=0, W=0
			163	Red (R=255, G=0, B=0, W=0)
			164–200	R=255, G=0, B+, W=0
			201	Magenta (R=255, G=0, B=255, W=0)
			202–238	R-, G=0, B=255, W=0
			239	Blue (R=0, G=0, B=255, W=0)
			240–247	Color fade with decreasing speed
248–255	color jump with decreasing speed			
10	11	Pattern 	000–005	No Function
			006–010	LED 1
			011–015	LED 2
			016–020	LED 3
			021–025	LED 4
			026–030	LED 5

24 CH	86 CH	Function	Value	Setting
			031-035	LED 6
			036-040	LED 1+2
			041-045	LED 2+3
			046-050	LED 3+4
			051-055	LED 4+5
			056-060	LED 5+6
			061-065	LED 6+1
			066-070	LED 1+3
			071-075	LED 2+4
			076-080	LED 3+5
			081-085	LED 4+6
			086-090	LED 5+1
			091-095	LED 6+2
			096-100	LED 1+4
			101-105	LED 2+5
			106-110	LED 3+6
			111-115	LED 1+2+3
			116-120	LED 2+3+4
			121-125	LED 3+4+5
			126-130	LED 4+5+6
			131-135	LED 5+6+1
			136-140	LED 6+1+2
			141-145	LED 1+2+4
			146-150	LED 1+2+5
			151-155	LED 2+3+5
			156-160	LED 2+3+6
			161-165	LED 3+4+6
			166-170	LED 1+3+4
			171-175	LED 1+3+5
			176-180	LED 2+4+6
			181-185	LED 1+2+3+4
			186-190	LED 2+3+4+5
			191-195	LED 3+4+5+6
			196-200	LED 4+5+6+1
			201-205	LED 4+5+6+1
			206-210	LED 1+2+5+6
			211-215	LED 1+2+3+6
			216-220	LED 1+2+3+4+5
			221-225	LED 2+3+4+5
			226-230	LED 1+3+4+5+6
			231-235	LED 1+2+4+5+6
			236-240	LED 1+2+3+5+6
			241-245	LED 1+2+3+4+6
			246-250	LED 1+2+3+4+5+6
			251-255	LED 1+2+3+4+5+6
11	12	LED Built-in Programs	000-015	No Function
			016-017	Built-in Program 1
			018-019	Built-in Program 2
			020-021	Built-in Program 3
			022-023	Built-in Program 4
			024-025	Built-in Program 5
			026-027	Built-in Program 6
			028-029	Built-in Program 7
			030-031	Built-in Program 8
			032-033	Built-in Program 9

24 CH	86 CH	Function	Value	Setting
			034–035	Built-in Program 10
			036–037	Built-in Program 11
			038–039	Built-in Program 12
			040–041	Built-in Program 13
			042–043	Built-in Program 14
			044–045	Built-in Program 15
			046–047	Built-in Program 16
			048–049	Built-in Program 17
			050–051	Built-in Program 18
			052–053	Built-in Program 19
			054–055	Built-in Program 20
			056–057	Built-in Program 21
			058–059	Built-in Program 22
			060–061	Built-in Program 23
			062–063	Built-in Program 24
			064–065	Built-in Program 25
			066–067	Built-in Program 26
			068–069	Built-in Program 27
			070–071	Built-in Program 28
			072–073	Built-in Program 29
			074–075	Built-in Program 30
			076–077	Built-in Program 31
			078–079	Built-in Program 32
			080–081	Built-in Program 33
			082–083	Built-in Program 34
			084–085	Built-in Program 35
			086–135	Built-in Program 36 (main built-in)
			136–137	Built-in Program 37
			138–139	Built-in Program 38
			140–141	Built-in Program 39
			142–143	Built-in Program 40
			144–145	Built-in Program 41
			146–147	Built-in Program 42
			148–149	Built-in Program 43
			150–151	Built-in Program 44
			152–153	Built-in Program 45
			154–155	Built-in Program 46
			156–157	Built-in Program 47
			158–159	Built-in Program 48
			160–161	Built-in Program 49
			162–163	Built-in Program 50
			164–165	Built-in Program 51
			166–167	Built-in Program 52
			168–169	Built-in Program 53
			170–171	Built-in Program 54
			172–173	Built-in Program 55
			174–175	Built-in Program 56
			176–177	Built-in Program 57
			178–179	Built-in Program 58
			180–181	Built-in Program 59
			182–183	Built-in Program 60
			184–185	Built-in Program 61
			186–187	Built-in Program 62
			188–189	Built-in Program 63
			190–191	Built-in Program 64

24 CH	86 CH	Function	Value	Setting
			192–193	Built-in Program 65
			194–195	Built-in Program 66
			196–197	Built-in Program 67
			198–199	Built-in Program 68
			200–201	Built-in Program 69
			202–203	Built-in Program 70
			204–205	Built-in Program 71
			206–255	Built-in Program 72 (main built-in)
12	13	LED Built-in Speed	000–127	Speed adjustment, from fast to slow
			128	Stop
			129–255	Speed adjustment, from slow to fast
13	14	LED Built-in Delay	000–127	Speed adjustment, from fast to slow
14	15	Background Color	000	No Function
			001–002	White 2700K(R=156, G=118, B=0, W=63)
			003–004	White 3200K(R=156, G=141, B=5, W=89)
			005–006	White 4200K(R=156, G=141, B=14, W=255)
			007–008	White 5600K(R=156, G=207, B=54, W=255)
			009–010	White 8000K(R=130, G=255, B=96, W=255)
			11	Blue (R=0, G=0, B=255, W=0)
			012–048	R=0, G+, B=255, W=0
			49	Cyan (R=0, G=255, B=255, W=0)
			050–086	R=0, G=255, B-, W=0
			87	Green (R=0, G=255, B=0, W=0)
			088–124	R+, G=255, B=0, W=0
			125	Yellow (R=255, G=255, B=0, W=0)
			126–162	R=255, G-, B=0, W=0
			163	Red (R=255, G=0, B=0, W=0)
			164–200	R=255, G=0, B+, W=0
			201	Magenta (R=255, G=0, B=255, W=0)
			202–238	R-, G=0, B=255, W=0
			239	Blue (R=0, G=0, B=255, W=0)
			240–247	Color fade with decreasing speed
			248–255	Color fade with decreasing speed
15	16	Background Color Dimmer	000–255	From low to high intensity (0–100 %)
	17	Background Color Dimmer 16-bit	000–255	From low to high intensity (0–100 %)
	18	Background Red Dimmer	000–255	From low to high intensity (0–100 %)
	19	Background Red Dimmer 16-bit	000–255	From low to high intensity (0–100 %)
	20	Background Green Dimmer	000–255	From low to high intensity (0–100 %)
	21	Background Green Dimmer 16-bit	000–255	From low to high intensity (0–100 %)
	22	Background Blue Dimmer	000–255	From low to high intensity (0–100 %)
	23	Background Blue Dimmer 16-bit	000–255	From low to high intensity (0–100 %)
	24	Background White Dimmer	000–255	From low to high intensity (0–100 %)
	25	Background White Dimmer 16-bit	000–255	From low to high intensity (0–100 %)

16	26	Frost (Fan Blade)	000–004	No Function
			005–255	Frost effect from 0-100%
17	27	Lens Rotating	000–063	Indexing
			064–095	Lens shaking increasing speed (small shaking)
			096–127	Lens shaking increasing speed (big shaking)
			128–191	Rotating decreasing speed
			192–255	Rotating increasing speed
18	28	Frost (On Top of the Light Guide)	000–255	Frost/Flower Effect
19	29	Zoom	000–255	Gradual zoom adjustment, from small to big
20	30	Control	000–009	No Function
			010–014	Pan/tilt blackout
			015–019	Reserved
			020–024	RGBW color mixing
			025–029	CMY color mixing
			030–049	Reserved
			050–054	Pan reset
			055–059	Tilt reset
			060–069	Reserved
			070–074	All reset
			075–079	Reserved
			080–084	Pan/tilt reverse
			085–089	Pan reverse
			090–094	Tilt reverse
			095–099	Disable pan reverse
			100–104	Disable tilt reverse
			105–109	Disable pan/tilt reverse
			110–114	Pan tilt fast
			115–119	Pan tilt slow
			120–124	Fan ECO
			125–129	Fan full
			130–134	Fan auto
			135–139	Dimmer fast
140–144	Dimmer smooth			
145–149	Linear curve			
150–154	Square curve			
155–159	I Squa curve			
160–164	S curve			
165–169	WHITE mode			
170–174	FULL mode			
175–255	Reserved			
21	31	Red Master Dimmer	000–255	From low to high intensity (0–100 %)
	32	Red Master Dimmer 16-bit	000–255	From low to high intensity (0–100 %)
22	33	Green Master Dimmer	000–255	From low to high intensity (0–100 %)
	34	Green Master Dimmer 16-bit	000–255	From low to high intensity (0–100 %)
23	35	Blue Master Dimmer	000–255	From low to high intensity (0–100 %)
	36	Blue Master Dimmer 16-bit	000–255	From low to high intensity (0–100 %)
24	37	White Master Dimmer	000–255	From low to high intensity (0–100 %)
	38	White Master Dimmer 16-bit	000–255	From low to high intensity (0–100 %)
	39	Red (C) LED 1	000–255	From low to high intensity (0–100 %)
	40	Red (C) LED 1 16-bit	000–255	From low to high intensity (0–100 %)
	41	Green (M) LED 1	000–255	From low to high intensity (0–100 %)
	42	Green (M) LED 1 16-bit	000–255	From low to high intensity (0–100 %)

43	Blue (Y) LED 1	000–255	From low to high intensity (0–100 %)
44	Blue (Y) LED 1 16-bit	000–255	From low to high intensity (0–100 %)
45	White LED 1	000–255	From low to high intensity (0–100 %)
46	White LED 1 16-bit	000–255	From low to high intensity (0–100 %)
47	Red (C) LED 2	000–255	From low to high intensity (0–100 %)
48	Red (C) LED 2 16-bit	000–255	From low to high intensity (0–100 %)
49	Green (M) LED 2	000–255	From low to high intensity (0–100 %)
50	Green (M) LED 2 16-bit	000–255	From low to high intensity (0–100 %)
51	Blue (Y) LED 2	000–255	From low to high intensity (0–100 %)
52	Blue (Y) LED 2 16-bit	000–255	From low to high intensity (0–100 %)
53	White LED 2	000–255	From low to high intensity (0–100 %)
54	White LED 2 16-bit	000–255	From low to high intensity (0–100 %)
55	Red (C) LED 3	000–255	From low to high intensity (0–100 %)
56	Red (C) LED 3 16-bit	000–255	From low to high intensity (0–100 %)
57	Green (M) LED 3	000–255	From low to high intensity (0–100 %)
58	Green (M) LED 3 16-bit	000–255	From low to high intensity (0–100 %)
59	Blue (Y) LED 3	000–255	From low to high intensity (0–100 %)
60	Blue (Y) LED 3 16-bit	000–255	From low to high intensity (0–100 %)
61	White LED 3	000–255	From low to high intensity (0–100 %)
62	White LED 3 16-bit	000–255	From low to high intensity (0–100 %)
63	Red (C) LED 4	000–255	From low to high intensity (0–100 %)
64	Red (C) LED 4 16-bit	000–255	From low to high intensity (0–100 %)
65	Green (M) LED 4	000–255	From low to high intensity (0–100 %)
66	Green (M) LED 4 16-bit	000–255	From low to high intensity (0–100 %)
67	Blue (Y) LED 4	000–255	From low to high intensity (0–100 %)
68	Blue (Y) LED 4 16-bit	000–255	From low to high intensity (0–100 %)
69	White LED 4	000–255	From low to high intensity (0–100 %)
70	White LED 4 16-bit	000–255	From low to high intensity (0–100 %)
71	Red (C) LED 5	000–255	From low to high intensity (0–100 %)
72	Red (C) LED 5 16-bit	000–255	From low to high intensity (0–100 %)
73	Green (M) LED 5	000–255	From low to high intensity (0–100 %)
74	Green (M) LED 5 16-bit	000–255	From low to high intensity (0–100 %)
75	Blue (Y) LED 5	000–255	From low to high intensity (0–100 %)
76	Blue (Y) LED 5 16-bit	000–255	From low to high intensity (0–100 %)
77	White LED 5	000–255	From low to high intensity (0–100 %)
78	White LED 5 16-bit	000–255	From low to high intensity (0–100 %)
79	Red (C) LED 6	000–255	From low to high intensity (0–100 %)
80	Red (C) LED 6 16-bit	000–255	From low to high intensity (0–100 %)
81	Green (M) LED 6	000–255	From low to high intensity (0–100 %)
82	Green (M) LED 6 16-bit	000–255	From low to high intensity (0–100 %)
83	Blue (Y) LED 6	000–255	From low to high intensity (0–100 %)
84	Blue (Y) LED 6 16-bit	000–255	From low to high intensity (0–100 %)
85	White LED 6	000–255	From low to high intensity (0–100 %)
86	White LED 6 16-bit	000–255	From low to high intensity (0–100 %)

Note: Make sure that the Master Dimmer channel and the Shutter/Strobe channel are open in order to see the light output.

6.7.3. 53 channels, 59 channels

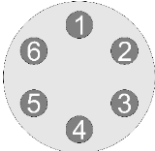
53 CH	59 CH	Function	Value	Setting
1	1	Pan	000–255	Pan adjustment 0°–540°
2	2	Tilt	000–255	Tilt adjustment 0°–270°
3	3	Pan, Fine	000–255	Pan adjustment, 16-bit
4	4	Tilt, Fine	000–255	Tilt adjustment, 16-bit
5	5	Pan/Tilt speed	000–255	Speed adjustment of the pan/tilt, from fast to slow
6	6	Master Dimmer	000–255	From low to high intensity (0–100 %)
7	7	Master Dimmer Fine	000–255	From low to high intensity (0–100 %)
8	8	Shutter/Strobe	000–019	Off
			020–024	On
			025–064	Strobe 1 with decreasing speed
			065–084	Strobe 2(fast on slow off) with decreasing speed
			085–104	Strobe 3(slw on fast off) with decreasing speed
			105–124	Strobe 4(random strobe) with decreasing speed
			125–144	Strobe 5(random fast on slow off)with decreasing speed
			145–164	Strobe 6(random slow on fast off) with decreasing speed
			165–184	Strobe 7(pulse strobe) with decreasing speed
			185–204	Strobe 8(random pulse strobe) with decreasing speed
			205–224	Strobe 9(fade on or off) with decreasing speed
225–244	Strobe 10(pulse strobe) with decreasing speed			
245–255	on			
9	9	CTC	000	No function
			001–255	From 19000K to 2700K
10	10	Color	000	No function
			001–002	White 2700K(R=156, G=118, B=0, W=63)
			003–004	White 3200K(R=156, G=141, B=5, W=89)
			005–006	White 4200K(R=156, G=141, B=14, W=255)
			007–008	White 5600K(R=156, G=207, B=54, W=255)
			009–010	White 8000K(R=130, G=255, B=96, W=255)
			011	Blue (R=0, G=0, B=255, W=0)
			012–048	R=0, G+, B=255, W=0
			49	Cyan (R=0, G=255, B=255, W=0)
			050–086	R=0, G=255, B-, W=0
			87	Green (R=0, G=255, B=0, W=0)
			088–124	R+, G=255, B=0, W=0
			125	Yellow (R=255, G=255, B=0, W=0)
			126–162	R=255, G-, B=0, W=0
			163	Red (R=255, G=0, B=0, W=0)
			164–200	R=255, G=0, B+, W=0
			201	Magenta (R=255, G=0, B=255, W=0)
			202–238	R-, G=0, B=255, W=0
			239	Blue (R=0, G=0, B=255, W=0)
240–247	Color fade with decreasing speed			
248–255	color jump with decreasing speed			
11	11	Pattern 	000–005	No Function
			006–010	LED 1
			011–015	LED 2
			016–020	LED 3
			021–025	LED 4
			026–030	LED 5

53 CH	59 CH	Function	Value	Setting
			031-035	LED 6
			036-040	LED 1+2
			041-045	LED 2+3
			046-050	LED 3+4
			051-055	LED 4+5
			056-060	LED 5+6
			061-065	LED 6+1
			066-070	LED 1+3
			071-075	LED 2+4
			076-080	LED 3+5
			081-085	LED 4+6
			086-090	LED 5+1
			091-095	LED 6+2
			096-100	LED 1+4
			101-105	LED 2+5
			106-110	LED 3+6
			111-115	LED 1+2+3
			116-120	LED 2+3+4
			121-125	LED 3+4+5
			126-130	LED 4+5+6
			131-135	LED 5+6+1
			136-140	LED 6+1+2
			141-145	LED 1+2+4
			146-150	LED 1+2+5
			151-155	LED 2+3+5
			156-160	LED 2+3+6
			161-165	LED 3+4+6
			166-170	LED 1+3+4
			171-175	LED 1+3+5
			176-180	LED 2+4+6
			181-185	LED 1+2+3+4
			186-190	LED 2+3+4+5
			191-195	LED 3+4+5+6
			196-200	LED 4+5+6+1
			201-205	LED 4+5+6+1
			206-210	LED 1+2+5+6
			211-215	LED 1+2+3+6
			216-220	LED 1+2+3+4+5
			221-225	LED 2+3+4+5
			226-230	LED 1+3+4+5+6
			231-235	LED 1+2+4+5+6
			236-240	LED 1+2+3+5+6
			241-245	LED 1+2+3+4+6
			246-250	LED 1+2+3+4+5+6
			251-255	LED 1+2+3+4+5+6
12	12	LED Built-in Programs	000-015	No Function
			016-017	Built-in Program 1
			018-019	Built-in Program 2
			020-021	Built-in Program 3
			022-023	Built-in Program 4
			024-025	Built-in Program 5
			026-027	Built-in Program 6
			028-029	Built-in Program 7
			030-031	Built-in Program 8
			032-033	Built-in Program 9

53 CH	59 CH	Function	Value	Setting
			034–035	Built-in Program 10
			036–037	Built-in Program 11
			038–039	Built-in Program 12
			040–041	Built-in Program 13
			042–043	Built-in Program 14
			044–045	Built-in Program 15
			046–047	Built-in Program 16
			048–049	Built-in Program 17
			050–051	Built-in Program 18
			052–053	Built-in Program 19
			054–055	Built-in Program 20
			056–057	Built-in Program 21
			058–059	Built-in Program 22
			060–061	Built-in Program 23
			062–063	Built-in Program 24
			064–065	Built-in Program 25
			066–067	Built-in Program 26
			068–069	Built-in Program 27
			070–071	Built-in Program 28
			072–073	Built-in Program 29
			074–075	Built-in Program 30
			076–077	Built-in Program 31
			078–079	Built-in Program 32
			080–081	Built-in Program 33
			082–083	Built-in Program 34
			084–085	Built-in Program 35
			086–135	Built-in Program 36 (main built-in)
			136–137	Built-in Program 37
			138–139	Built-in Program 38
			140–141	Built-in Program 39
			142–143	Built-in Program 40
			144–145	Built-in Program 41
			146–147	Built-in Program 42
			148–149	Built-in Program 43
			150–151	Built-in Program 44
			152–153	Built-in Program 45
			154–155	Built-in Program 46
			156–157	Built-in Program 47
			158–159	Built-in Program 48
			160–161	Built-in Program 49
			162–163	Built-in Program 50
			164–165	Built-in Program 51
			166–167	Built-in Program 52
			168–169	Built-in Program 53
			170–171	Built-in Program 54
			172–173	Built-in Program 55
			174–175	Built-in Program 56
			176–177	Built-in Program 57
			178–179	Built-in Program 58
			180–181	Built-in Program 59
			182–183	Built-in Program 60
			184–185	Built-in Program 61
			186–187	Built-in Program 62
			188–189	Built-in Program 63
			190–191	Built-in Program 64

53 CH	59 CH	Function	Value	Setting
			192–193	Built-in Program 65
			194–195	Built-in Program 66
			196–197	Built-in Program 67
			198–199	Built-in Program 68
			200–201	Built-in Program 69
			202–203	Built-in Program 70
			204–205	Built-in Program 71
			206–255	Built-in Program 72 (main built-in)
13	13	LED Built-in Speed	000–127	Speed adjustment, from fast to slow
			128	Stop
			129–255	Speed adjustment, from slow to fast
14	14	LED Built-in Delay	000–127	Speed adjustment, from fast to slow
15	15	Background Color	000	No Function
			001–002	White 2700K(R=156, G=118, B=0, W=63)
			003–004	White 3200K(R=156, G=141, B=5, W=89)
			005–006	White 4200K(R=156, G=141, B=14, W=255)
			007–008	White 5600K(R=156, G=207, B=54, W=255)
			009–010	White 8000K(R=130, G=255, B=96, W=255)
			11	Blue (R=0, G=0, B=255, W=0)
			012–048	R=0, G+, B=255, W=0
			49	Cyan (R=0, G=255, B=255, W=0)
			050–086	R=0, G=255, B-, W=0
			87	Green (R=0, G=255, B=0, W=0)
			088–124	R+, G=255, B=0, W=0
			125	Yellow (R=255, G=255, B=0, W=0)
			126–162	R=255, G-, B=0, W=0
			163	Red (R=255, G=0, B=0, W=0)
			164–200	R=255, G=0, B+, W=0
			201	Magenta (R=255, G=0, B=255, W=0)
			202–238	R-, G=0, B=255, W=0
			239	Blue (R=0, G=0, B=255, W=0)
			240–247	Color fade with decreasing speed
248–255	Color fade with decreasing speed			
16	16	Background Color Dimmer	000–255	From low to high intensity (0–100 %)
17	17	Background Red Dimmer	000–255	From low to high intensity (0–100 %)
18	18	Background Green Dimmer	000–255	From low to high intensity (0–100 %)
19	19	Background Blue Dimmer	000–255	From low to high intensity (0–100 %)
20	20	Background White Dimmer	000–255	From low to high intensity (0–100 %)
21	21	Frost (Fan Blade)	000–004	No Function
			005–255	Frost effect from 0-100%
22	22	Lens Rotating	000–063	Indexing
			064–095	Lens shaking increasing speed (small shaking)
			096–127	Lens shaking increasing speed (big shaking)
			128–191	Rotating decreasing speed
			192–255	Rotating increasing speed
23	23	Frost (On Top of the Light Guide)	000–255	Frost/Flower Effect
24	24	Zoom	000–255	Gradual zoom adjustment, from small to big

			000-009	No Function
			010-014	Pan/tilt blackout
			015-019	Reserved
			020-024	RGBW color mixing
			025-029	CMY color mixing
			030-049	Reserved
			050-054	Pan reset
			055-059	Tilt reset
			060-069	Reserved
			070-074	All reset
			075-079	Reserved
			080-084	Pan/tilt reverse
			085-089	Pan reverse
			090-094	Tilt reverse
			095-099	Disable pan reverse
			100-104	Disable tilt reverse
			105-109	Disable pan/tilt reverse
			110-114	Pan tilt fast
			115-119	Pan tilt slow
			120-124	Fan ECO
			125-129	Fan full
			130-134	Fan auto
			135-139	Dimmer fast
			140-144	Dimmer smooth
			145-149	Linear curve
			150-154	Square curve
			155-159	I Squa curve
			160-164	S curve
			165-169	WHITE mode
			170-174	FULL mode
			175-255	Reserved
25	25	Control		
26	26	Red Master Dimmer	000-255	From low to high intensity (0-100 %)
27	27	Green Master Dimmer	000-255	From low to high intensity (0-100 %)
28	28	Blue Master Dimmer	000-255	From low to high intensity (0-100 %)
29	29	White Master Dimmer	000-255	From low to high intensity (0-100 %)
	30	Dimmer LED 1	000-255	From low to high intensity (0-100 %)
30	31	Red (C) LED 1	000-255	From low to high intensity (0-100 %)
31	32	Green (M) LED 1	000-255	From low to high intensity (0-100 %)
32	33	Blue (Y) LED 1	000-255	From low to high intensity (0-100 %)
33	34	White LED 1	000-255	From low to high intensity (0-100 %)
	35	Dimmer LED 2	000-255	From low to high intensity (0-100 %)
34	36	Red (C) LED 2	000-255	From low to high intensity (0-100 %)
35	37	Green (M) LED 2	000-255	From low to high intensity (0-100 %)
36	38	Blue (Y) LED 2	000-255	From low to high intensity (0-100 %)
37	39	White LED 2	000-255	From low to high intensity (0-100 %)
	40	Dimmer LED 3	000-255	From low to high intensity (0-100 %)
38	41	Red (C) LED 3	000-255	From low to high intensity (0-100 %)
39	42	Green (M) LED 3	000-255	From low to high intensity (0-100 %)
40	43	Blue (Y) LED 3	000-255	From low to high intensity (0-100 %)
41	44	White LED 3	000-255	From low to high intensity (0-100 %)
	45	Dimmer LED 4	000-255	From low to high intensity (0-100 %)
42	46	Red (C) LED 4	000-255	From low to high intensity (0-100 %)
43	47	Green (M) LED 4	000-255	From low to high intensity (0-100 %)
44	48	Blue (Y) LED 4	000-255	From low to high intensity (0-100 %)
45	49	White LED 4	000-255	From low to high intensity (0-100 %)
	50	Dimmer LED 5	000-255	From low to high intensity (0-100 %)
46	51	Red (C) LED 5	000-255	From low to high intensity (0-100 %)

47	52	Green (M) LED 5	000–255	From low to high intensity (0–100 %)
48	53	Blue (Y) LED 5	000–255	From low to high intensity (0–100 %)
49	54	White LED 5	000–255	From low to high intensity (0–100 %)
	55	Dimmer LED 5	000–255	From low to high intensity (0–100 %)
50	56	Red (C) LED 6	000–255	From low to high intensity (0–100 %)
51	57	Green (M) LED 6	000–255	From low to high intensity (0–100 %)
52	58	Blue (Y) LED 6	000–255	From low to high intensity (0–100 %)
53	59	White LED 6	000–255	From low to high intensity (0–100 %)

7. Troubleshooting

This troubleshooting guide contains solutions to problems which can be carried out by an ordinary person. The device does not contain user-serviceable parts.

Unauthorized modifications to the device will render the warranty void. Such modifications may result in injuries and material damage.

Refer servicing to instructed or skilled persons. Contact your Highlite International dealer in case the solution is not described in the table.

Problem	Probable cause(s)	Solution
The device does not function at all	No power to the device	<ul style="list-style-type: none"> Check if power is switched on and cables are plugged in
	Main fuse is blown	<ul style="list-style-type: none"> Replace the fuse. See 8.3.1. Replacing the Fuse on page 47.
The device responds erratically	The factory settings of the device are changed	<ul style="list-style-type: none"> Reset the device's parameters to the default factory settings. See 6.6.5. Reset Functions on page 28
The device does not respond to DMX control	The controller is not connected	<ul style="list-style-type: none"> Connect the controller
	The signal is reversed. The 5-pin DMX OUT of the controller does not match the DMX IN of the device	<ul style="list-style-type: none"> Install a phase-reversing cable between the controller and the device
	The controller is defective	<ul style="list-style-type: none"> Try using another controller
The device responds erratically to DMX control	Bad data link connection	<ul style="list-style-type: none"> Examine connections and cables. Correct poor connections. Repair or replace damaged cables
	The data link is not terminated with a 120 Ω termination plug	<ul style="list-style-type: none"> Insert a termination plug in the DMX OUT connector of the last device on the link
	Incorrect addressing	<ul style="list-style-type: none"> Check address settings and correct, if necessary
	In case of a setup with multiple devices, one of the devices is defective and disturbs data transmission on the link	<ul style="list-style-type: none"> To find which device is defective, bypass one device at a time until normal operation is restored
No light or LEDs cut out intermittently	LEDs are damaged	<ul style="list-style-type: none"> Disconnect the device and contact your Highlite International dealer
	The power supply settings do not match local AC voltage and frequency	<ul style="list-style-type: none"> Disconnect the device. Check the settings and correct, if necessary

8. Maintenance

8.1. Safety Instructions for Maintenance



DANGER
Electric shock caused by dangerous voltage inside

Disconnect power supply before servicing or cleaning.



WARNING
Risk of burns due to hot surface

Allow the device to cool down for at least 15 minutes before servicing or cleaning.

8.2. Preventive Maintenance



Attention
Before each use, examine the device visually for any defects.

Make sure that:

- All screws used for installing the device or parts of the device are tightly fastened and are not corroded.
- The safety devices are not damaged.
- There are no deformations on housings, fixations and installation points.
- The lens is not cracked or damaged.
- The power cables are not damaged and do not show any material fatigue.

8.2.1. Basic Cleaning Instructions

The external lens of the device must be cleaned periodically in order to optimize the light output. The cleaning schedule depends on the conditions at the site where the device is installed. When smoke or fog machines are used at the site, the device will need more frequent cleaning. On the other hand, if the device is installed in well-ventilated area, it will need less frequent cleaning. To establish a cleaning schedule, examine the device at regular intervals during the first 100 hours of operation.

To clean the device, follow the steps below:

- 01) Disconnect the device from the electrical power supply.
- 02) Allow the device to cool down for at least 15 minutes.
- 03) Remove the dust collected on the external surface with dry compressed air and a soft brush.
- 04) Clean the lens with a damp cloth. Use a mild detergent solution.
- 05) Dry the lens carefully with a lint-free cloth.
- 06) Clean the DMX and other connections with a damp cloth.



Attention

- Do not immerse the device in liquid.
- Do not use alcohol or solvents.
- Make sure that the connections are fully dry before connecting the device to the power supply and to other devices.

8.3. Corrective Maintenance

The device does not contain user-serviceable parts. Do not open the device and do not modify the device.

Refer repairs and servicing to instructed or skilled persons. Contact your Highlite International dealer for more information.

8.3.1. Replacing the Fuse



DANGER Electric shock caused by short-circuit

- Do not bypass the thermostatic switch or fuses.
- For replacement use fuses of the same type and rating only.

Power surges, short-circuit or incorrect electrical power supply may cause a fuse to burn out. If the fuse burns out, the device will not function anymore. If this happens, follow the steps below.

- 01) Disconnect the device from the electrical power supply.
- 02) Allow the device to cool down for at least 15 minutes.
- 03) Loosen the fuse cover with a screwdriver and remove the fuse holder.
- 04) If the fuse is brown or unclear, it is burned out. Remove the old fuse.
- 05) Insert a new fuse in the fuse holder. Make sure that the type and the rating of the replacement fuse are the same as the ones specified on the information label of the product.
- 06) Replace the fuse holder in the opening and tighten the fuse cover.

9. Deinstallation, Transportation and Storage

9.1. Instructions for Deinstallation



WARNING

Incorrect deinstallation can cause serious injuries and damage of property.

- Let the device cool down before dismantling.
- Disconnect power supply before deinstallation.
- Always observe the national and site-specific regulations during deinstallation and derigging of the device.
- Wear personal protective equipment in compliance with the national and site-specific regulations.

9.2. Instructions for Transportation

- Use the original packaging to transport the device, if possible.
- Always observe the handling instructions printed on the outer carton box, for example: "Handle with care", "This side up", "Fragile".

9.3. Storage

- Clean the device before storing. Follow the cleaning instructions in chapter **8.2.1. Basic Cleaning Instructions** on page 47.
- Store the device in the original packaging, if possible.

10. Disposal

Correct disposal of this product



Waste Electrical and Electronic Equipment

This symbol on the product, its packaging or documents indicates that the product shall not be treated as household waste. Dispose of this product by handing it to the respective collection point for recycling of electrical and electronic equipment. This is to avoid environmental damage or personal injury due to uncontrolled waste disposal. For more detailed information about recycling of this product contact the local authorities or the authorized dealer.

11. Approval



Check the respective product page on the website of Highlite International (www.highlite.com) for an available declaration of conformity.



©2021 Infinity