

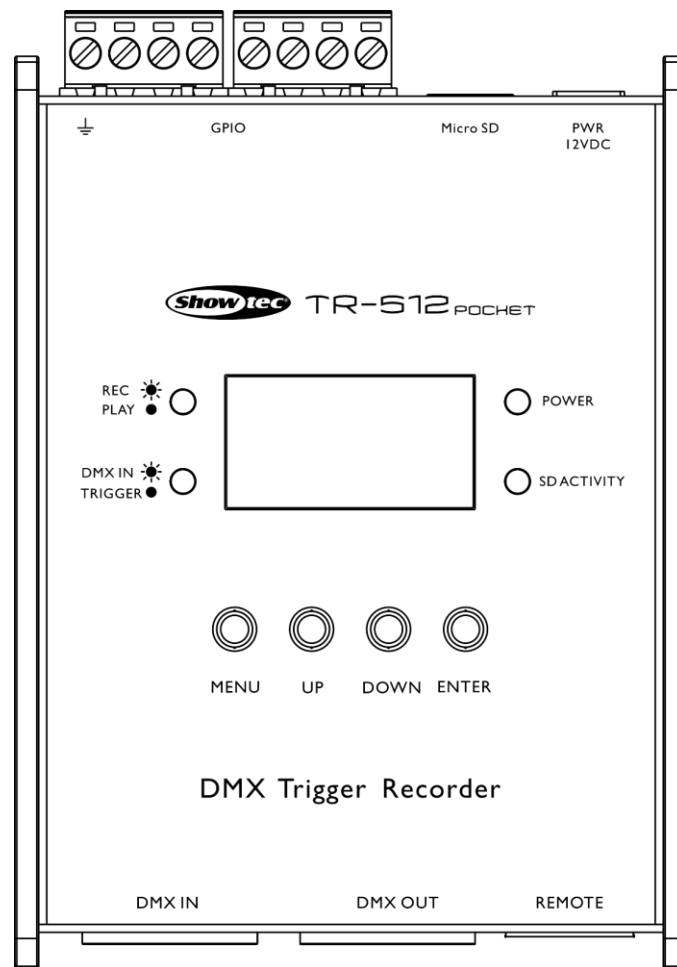

USER MANUAL



ENGLISH

TR-512 Pocket

V1

Product code: 50823

Preface

Thank you for purchasing this Showtec product.

The purpose of this user manual is to provide instructions for the correct and safe use of this product.

Keep the user manual for future reference as it is an integral part of the product. The user manual shall be stored at an easily accessible location.

This user manual contains information concerning:

- Safety instructions
- Installation and operation of the device
- Intended and non-intended use of the device
- Maintenance procedures
- Troubleshooting
- Transport, storage and disposal of the device

Non-observance of the instructions in this user manual may result in serious injuries and damage of property.

©2021 Showtec. All rights reserved.

No part of this document may be copied, published or otherwise reproduced without the prior written consent of Highlite International.

Design and product specifications are subject to change without prior notice.

For the latest version of this document or other language versions, please visit our website www.highlite.com or contact us at service@highlite.com.

Highlite International and its authorized service providers are not liable for any injury, damage, direct or indirect loss, consequential or economic loss or any other loss arising from the use of, or inability to use or reliance on the information contained in this document.

Table of contents

1. Introduction	4
1.1. Before Using the Product	4
1.2. Intended Use	4
1.3. Text Conventions	4
1.4. Symbols and Signal Words.....	5
1.5. Symbols on the Information Label	5
2. Safety	6
2.1. Warnings and Safety Instructions	6
2.2. Requirements for the User.....	7
3. Description of the Device	8
3.1. Front View	8
3.2. Product Specifications	9
3.3. Optional Accessories	9
3.4. Dimensions	10
4. Installation	10
4.1. Safety Instructions for Installation	10
4.2. Installation Site Requirements	10
4.3. Connecting to Power Supply	10
5. Setup	11
5.1. Warnings and Precautions	11
5.2. DMX Connection.....	11
5.2.1. DMX-512 Protocol.....	11
5.2.2. DMX Cables.....	11
5.3. Setup Examples	12
5.3.1. Program Recording Setup	12
5.3.2. Program Playing Setup	12
5.3.2.1. Connecting External Trigger Devices	13
5.3.2.2. Connecting the Wall Panel	14
6. Operation	16
6.1. Safety Instructions for Operation	16
6.2. Start-up	16
6.3. Control Panel	17
6.4. Recording a Program	17
6.5. Playing a Program.....	17
6.6. Trigger Monitoring	18
6.7. LED Statuses	18
6.8. Menu Overview	19
6.9. Main Menu Options	20
6.9.1. Play Show	20
6.9.1.1. Show	20
6.9.1.2. Playback Mode	21
6.9.2. Record Show	21
6.9.2.1. Name	21
6.9.2.2. Record Mode	22
6.9.3. Delete Show	22
6.9.4. Trigger Event	23
6.9.4.1. Status	23
6.9.4.2. Rename.....	23
6.9.4.3. Show	24
6.9.4.4. Trigger Mode	24
6.9.4.5. Delay.....	24
6.9.5. Stop TR Event	25
6.9.6. Blackout File.....	25

6.9.7.	Device Settings	26
6.9.7.1.	Device Label	26
6.9.7.2.	DMX Trigger Option.....	27
6.9.7.3.	DMX Port Option.....	27
6.9.7.4.	Display Option	28
6.9.7.5.	Version	28
6.9.8.	Save Configuration	29
6.9.9.	Load Configuration.....	30
6.9.10.	Default Setting	30
6.10.	DMX Channels.....	30
7.	Troubleshooting	31
8.	Maintenance	31
8.1.	Preventive Maintenance	31
8.1.1.	Basic Cleaning Instructions	31
8.2.	Corrective Maintenance	32
9.	Deinstallation, Transportation and Storage	32
10.	Disposal	32
11.	Approval.....	32

1. Introduction

1.1. Before Using the Product



Important

Read and follow the instructions in this user manual before installing, operating or servicing this product.

The manufacturer will not accept liability for any resulting damages caused by the non-observance of this manual.

After unpacking, check the contents of the box. If any parts are missing or damaged, contact your Highlite International dealer.

Your shipment includes:

- Showtec TR-512 Pocket
- AC power adapter 12 V DC (1,2 m)
- MicroSD card
- User manual

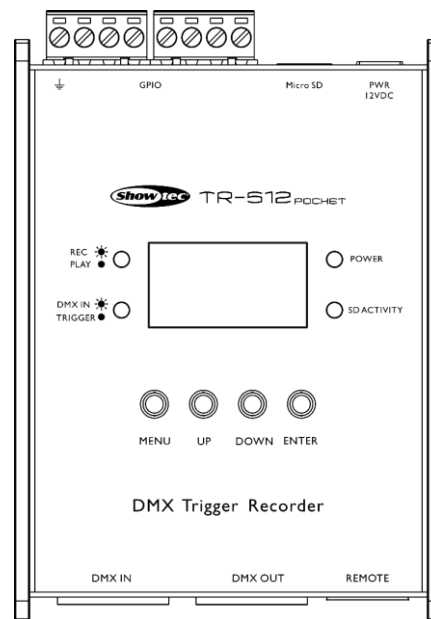

Fig. 01

1.2. Intended Use

This device is designed to be used as a professional DMX trigger/recorder. This device is not suitable for households.

Any other use, not mentioned under intended use, is regarded as non-intended and incorrect use.

1.3. Text Conventions







Throughout the user manual the following text conventions are used:

- Buttons: All buttons are in bold lettering, for example "Press the **UP/DOWN** buttons"
- References: References to chapters and parts of the device are in bold lettering, for example: "Refer to **2. Safety**", "press the **power switch (03)**"
- 0–255: Defines a range of values
- Notes: **Note:** (in bold lettering) is followed by useful information or tips

1.4. Symbols and Signal Words

Safety notes and warnings are indicated throughout the user manual by safety signs.

Always follow the instructions provided in this user manual.

- 
DANGER Indicates an imminently hazardous situation which, if not avoided, will result in death or serious injury.
- 
WARNING Indicates an imminently hazardous situation which, if not avoided, could result in death or serious injury.
- 
CAUTION Indicates a potentially hazardous situation, which, if not avoided, may result in minor or moderate injury.
- 
Attention Indicates important information for the correct operation and use of the product.
- 
Important Read and observe the instructions in this document.
- 
Disposal Provides important information about the disposal of this product.

1.5. Symbols on the Information Label

This product is provided with an information label. The information label is located on the bottom plate of the device.

The information label contains the following symbols:

- 

This device is designed for indoor use.
- 

This device is IEC protection class III.
- 

This device shall not be treated as household waste.
- 

Read and observe the instructions in this document.

2. Safety

**Important**

Read and follow the instructions in this user manual before installing, operating or servicing this product.

The manufacturer will not accept liability for any resulting damages caused by the non-observance of this manual.

2.1. Warnings and Safety Instructions

**DANGER**

Electric shock caused by short-circuit

This device is delivered with an AC power adapter. Incorrect handling of the AC power adapter may result in hazardous situations.

- Use only the AC power adapter delivered with the device.
- Do not wrap the power cable around the power adapter or any other object. This can damage the internal wires.
- Do not cover the power adapter with anything when it is plugged into the socket-outlet. This may cause overheating.
- Do not expose the power adapter to water or other liquids.

Do not use the power adapter:

- If it shows signs of overheating, for example the plastic is damaged.
- If the AC input pins show signs of corrosion or overheating.
- If the power cable is damaged or shows signs of material fatigue.

**Attention**

Power supply

This device falls under IEC protection class III. This device shall be connected to an external power supply.

- Before connecting the AC power adapter to the power supply, make sure that the current, voltage and frequency match the input voltage, current and frequency specified on the information label on the AC power adapter.
- Make sure that the cross-sectional area of the power cable is sufficient for the required power consumption of the device.

**Attention
General safety**

- Do not switch the device on and off in short intervals. This decreases the device's life.
- Do not shake the device. Avoid brute force when installing or operating the device.
- If the device is exposed to extreme temperature variations (e.g. after transportation), do not switch it on immediately. Let the device reach room temperature before switching it on, otherwise it may be damaged by the formed condensation.
- If the device fails to work properly, discontinue the use immediately.

**Attention
For professional use only
This device shall be used only for the purposes it is designed for.**

This device is designed to be used as a professional DMX trigger/recorder. This device is not suitable for households. Any incorrect use may lead to hazardous situations and result in injuries and material damage.

- This device is not suitable for households.
- This device does not contain user-serviceable parts. Unauthorized modifications to the device will render the warranty void. Such modifications may result in injuries and material damage.

**Attention
Do not expose the device to conditions that exceed the rated IP class conditions.**

This device is IP20 rated. IP (Ingress Protection) 20 class provides protection against solid objects greater than 12 mm, such as fingers, and no protection against harmful ingress of water.

2.2. Requirements for the User

This product may be used by ordinary persons. Maintenance, installation and service shall be carried out only by instructed or skilled persons. Contact your Highlite International dealer for more information.

Instructed persons have been instructed and trained by a skilled person, or are supervised by a skilled person, for specific tasks and work activities associated with the service of this product, so that they can identify risks and take precautions to avoid them.

Skilled persons have training or experience, which enables them to recognize risks and to avoid hazards associated with the service of this product.

Ordinary persons are all persons other than instructed persons and skilled persons. Ordinary persons include not only users of the product but also any other persons that may have access to the device or who may be in the vicinity of the device.

3. Description of the Device

The TR-512 Pocket is a compact but very powerful tool which can be used for triggering any light show or scene in a simple way. It can record and play several DMX programs at the same time. Those programs can be stored on a microSD card. Programs can be played by 6 external triggers or by the internal auto trigger. The TR-512 Pocket is suitable for a large range of venues, such as: theme parks, museums, shops and many others.

3.1. Front View

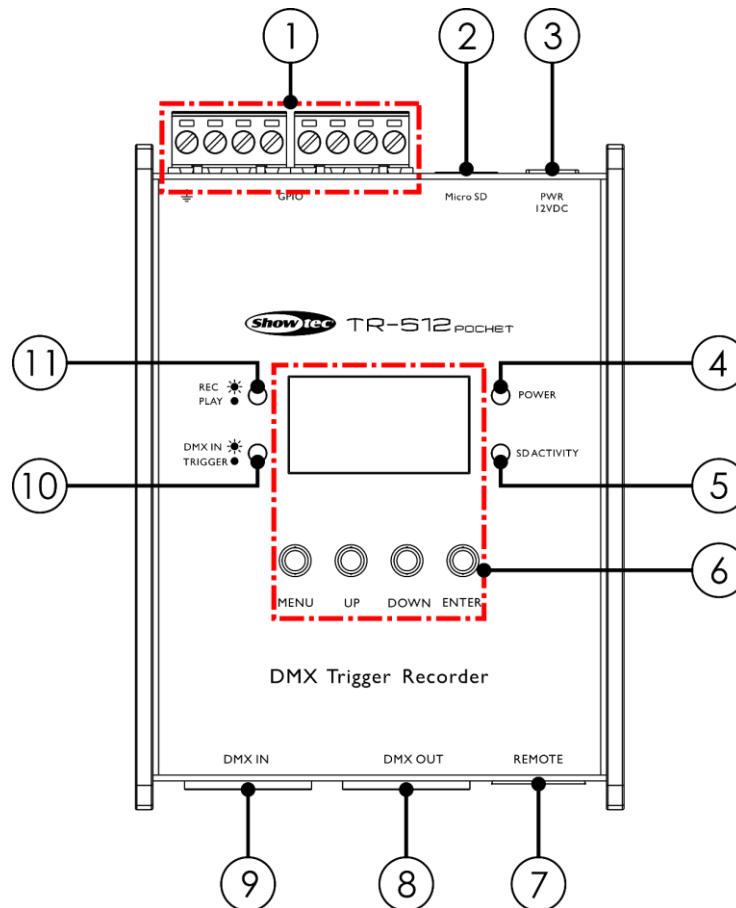

Fig. 02

- 01) Triggers 1–6 (GPIO), 2 x 3-pin Phoenix terminal connector IN
- 02) MicroSD card slot
- 03) DC connector, 12 V DC
- 04) Power LED indicator (red)
- 05) MicroSD LED indicator (yellow)
- 06) OLED display + control buttons
- 07) Remote trigger connector RJ45 IN
- 08) 3-pin DMX signal connector OUT
- 09) 3-pin DMX signal connector IN
- 10) DMX IN/Trigger LED indicator (blue)
- 11) Play/Record LED indicator (green)

3.2. Product Specifications

Model:	TR-512 Pocket
--------	---------------

Electrical:	
Power supply (external):	12 V DC
Power consumption:	6 W

Physical:	
Dimensions:	122 x 88 x 45 mm (LxWxH)
Weight:	0,38 kg

Operation and control:	
Control protocols:	DMX-512
Control panel:	OLED display and buttons
Control modes:	DMX-512A, Wall Remote, GPIO, Manual
MicroSD card capacity:	8 GB
DMX channels:	512
Universes:	1

Connections:	
Power connection:	Low voltage DC plug
DMX connection:	3-pin DMX signal connector IN/OUT
Data connection:	RJ45
Trigger connections:	2 x 4-pin Phoenix terminal trigger GPIO connector IN (maximum cable gauge: 1,5 mm ² / AWG: 12)

Construction:	
Housing:	Metal
Color:	Black
IP rating:	IP20

Thermal:	
Ambient temperature t_a :	From 0 °C to 40 °C

3.3. Optional Accessories

You can additionally purchase the following accessories:

Product code: [50827](#) (Wall Panel Remote for TR-512 Install/Pocket, Black)

Product code: [50828](#) (Wall Panel Remote for TR-512 Install/Pocket, Silver)

3.4. Dimensions

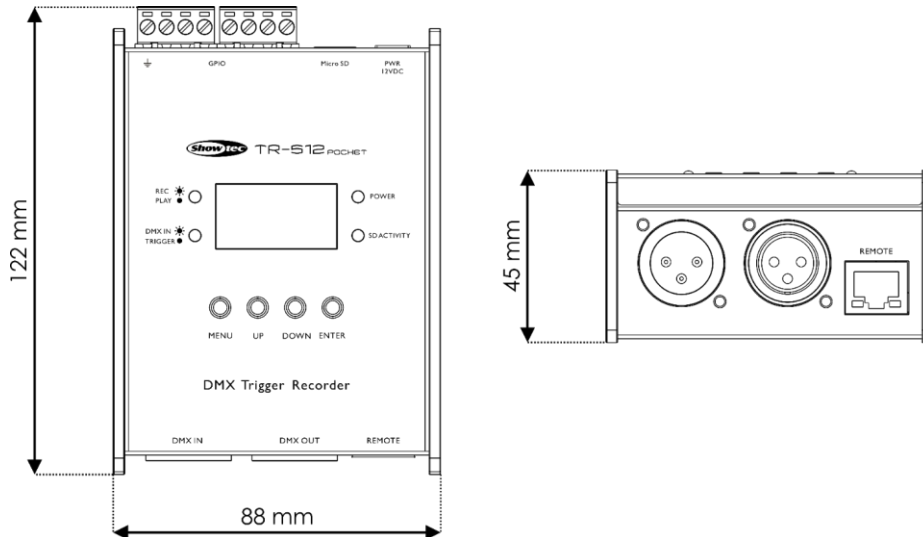

Fig. 03

4. Installation

4.1. Safety Instructions for Installation



WARNING

Incorrect installation can cause serious injuries and damage of property.

The installation of this device shall be carried out only by instructed or skilled persons.

4.2. Installation Site Requirements

- The device must be installed only indoors.
- The device can be positioned on a flat surface.
- The maximum ambient temperature $t_a = 40\text{ °C}$ must never be exceeded.
- The relative humidity must not exceed 50 % with an ambient temperature of 40 °C.

4.3. Connecting to Power Supply



Attention

Power supply

This device falls under IEC protection class III. This device shall be connected to an external power supply.

This device is delivered with an AC power adapter. Before connecting the AC power adapter to the socket-outlet, make sure that the power supply matches the Input voltage specified on the information label on the AC power adapter.

To turn the device on, follow the steps below:

- 01) Connect the AC power adapter to the device. Use only the AC power adapter delivered with the device.
- 02) Connect the AC power adapter to the socket-outlet.

5. Setup

5.1. Warnings and Precautions



Attention
 Connect all data cables before supplying power.
 Disconnect power supply before connecting or disconnecting data cables.

5.2. DMX Connection

5.2.1. DMX-512 Protocol

Use a DMX-512 controller to create DMX programs and send them to the TR-512 Pocket where they will be stored on the microSD card.

The TR-512 Pocket has 3-pin DMX signal IN and OUT connectors.

The pin assignment is as follows:

- 3-pin: pin 1 (ground), pin 2 (-), pin 3 (+)

Note:

- Maximum recommended DMX data link distance: 300 m

5.2.2. DMX Cables

Shielded twisted-pair cables must be used for reliable DMX connection. You can purchase DMX cables directly from your Highlite International dealer or make your own cables.

If you use XLR audio cables for DMX data transmission, this may lead to signal degradation and unreliable operation of the DMX network.

When you make your own DMX cables, make sure that you connect the pins and wires correctly as shown in Fig. 04 on page 11.

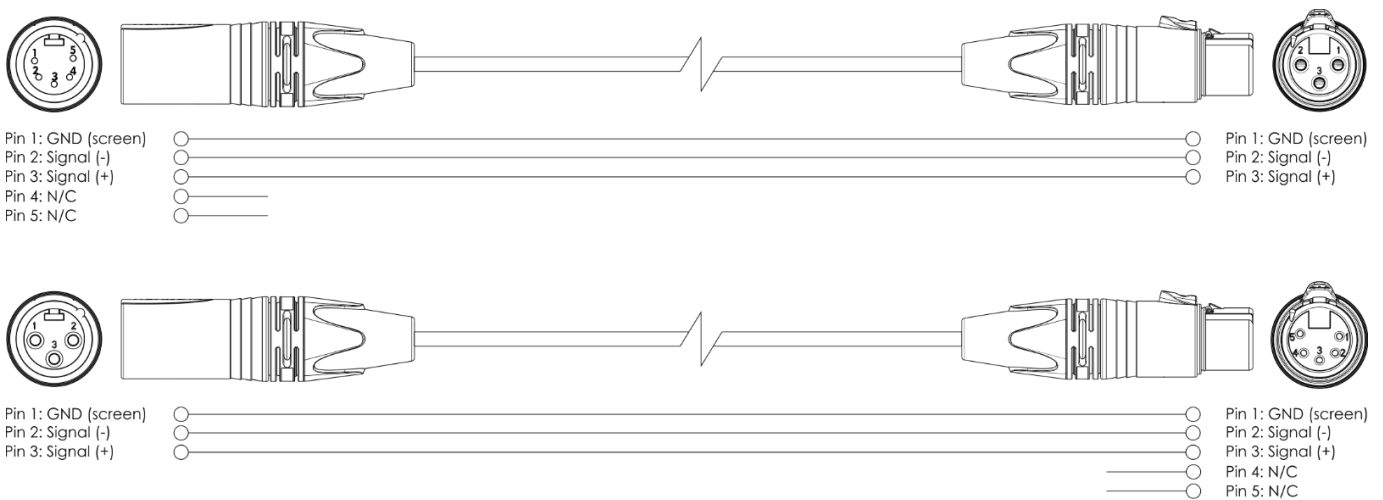

Fig. 04

5.3. Setup Examples

5.3.1. Program Recording Setup

- 01) Connect a DMX-512 light controller to the device's **3-pin DMX signal connector IN (09)** and connect light fixtures to the device's **3-pin DMX signal connector OUT (08)**.

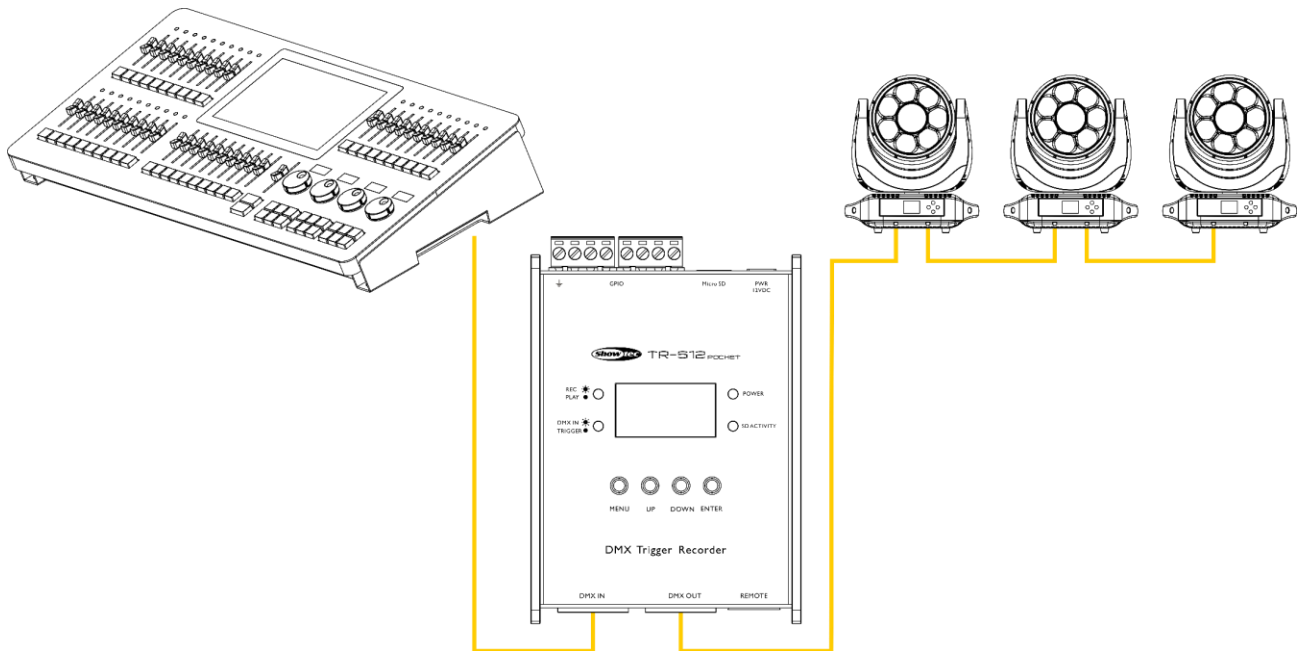

Fig. 05

- 02) Follow the instructions from **6.4. Recording a Program** on page 17.

5.3.2. Program Playing Setup

- 01) After recording, disconnect power supply from the devices.
- 02) Connect the external trigger devices. See **5.3.2.1. Connecting External Trigger Devices** on page 13 or **5.3.2.2. Connecting the Wall Panel** on page 14, for more information.
- 03) Follow the instructions from **6.5. Playing a Program** on page 17.

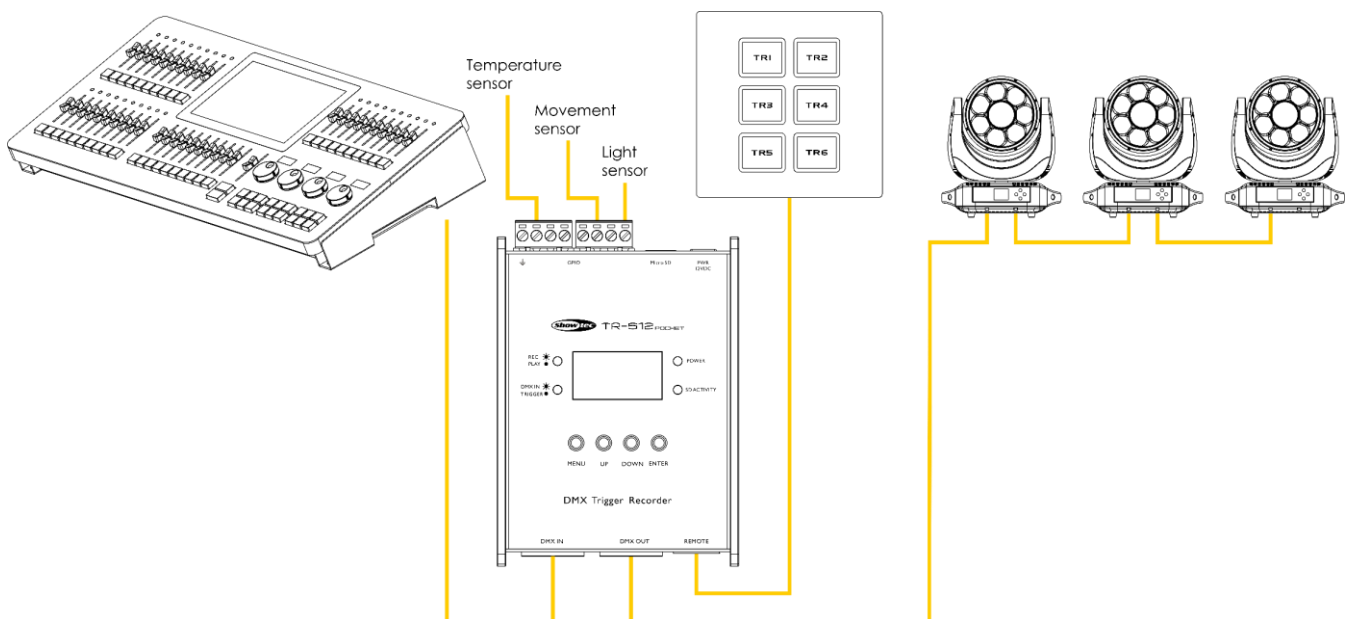

Fig. 06

5.3.2.1. Connecting External Trigger Devices

01) Remove the 3-pin 1-6 GPIO Phoenix terminal connectors IN (01).

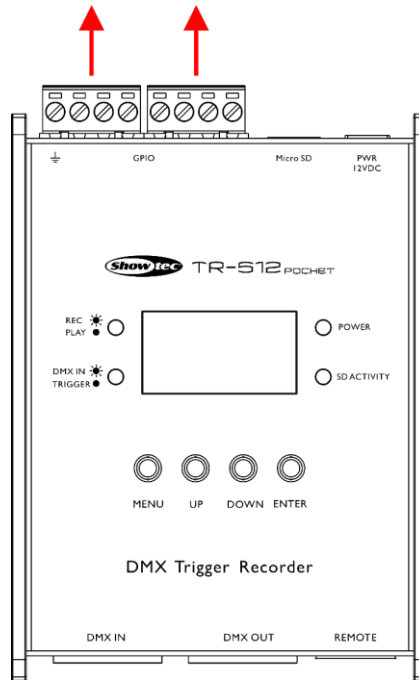

Fig. 07

02) Connect the desired external trigger devices (movement sensors, temperature sensors, light sensors, etc.) to the device's 3-pin 1-6 GPIO Phoenix terminal connectors IN (01).

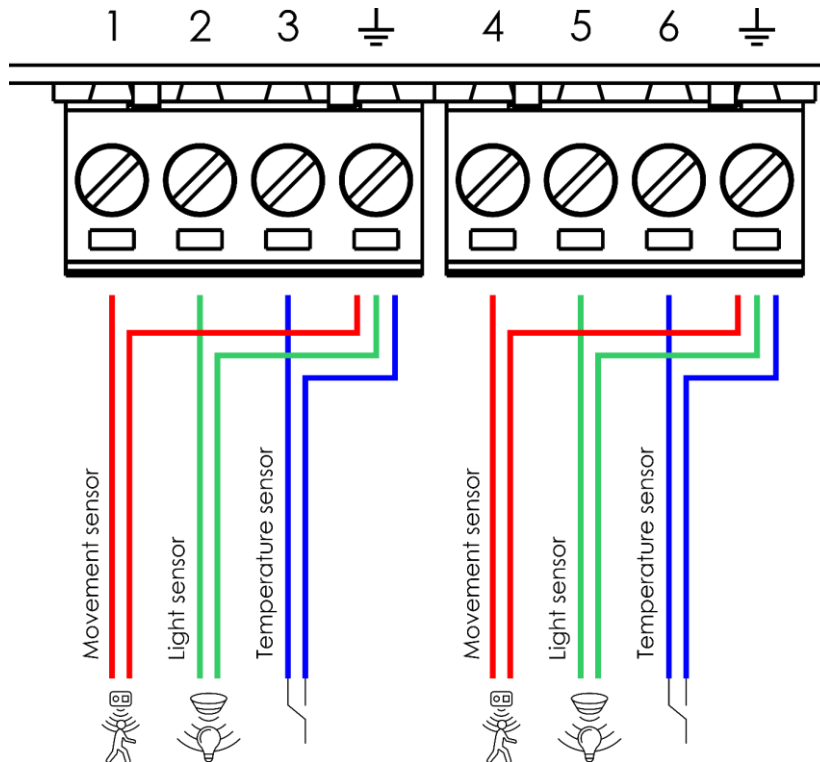

Fig. 08

5.3.2.2. Connecting the Wall Panel

You can connect the optional Wall Panel Remote for TR-512 Install/Pocket (product code: 50827/50828) in order to trigger programs.

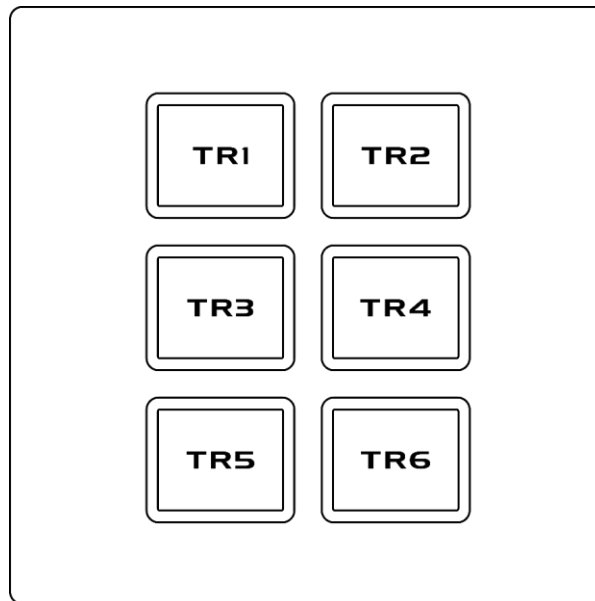

Fig. 09

- 01) Connect the wall panel to the device with an RJ-45 cable. Recommended maximum cable length: 25 m.
- 02) Install the wall panel in two ways, with or without the jumper. See Fig. 10.
 - With the jumper: Set the TR-512 Pocket to TOGGLE_TR. See **6.9.4.4. Trigger Mode** on page 24 for more information.
 - Without the jumper: Set the TR-512 Pocket to NO_TR. See **6.9.4.4. Trigger Mode** on page 24 for more information.

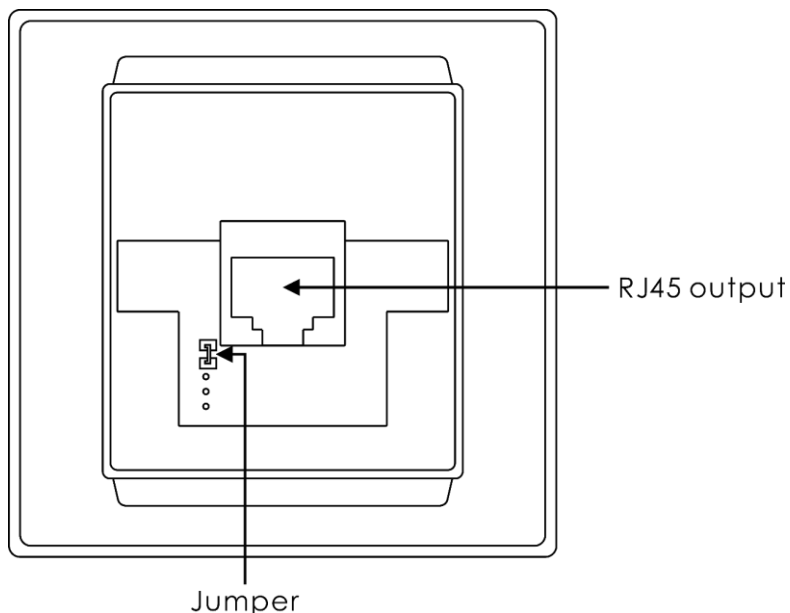

Fig. 10

03) Make sure that the RJ45 cable has the following pinout:

Pinout

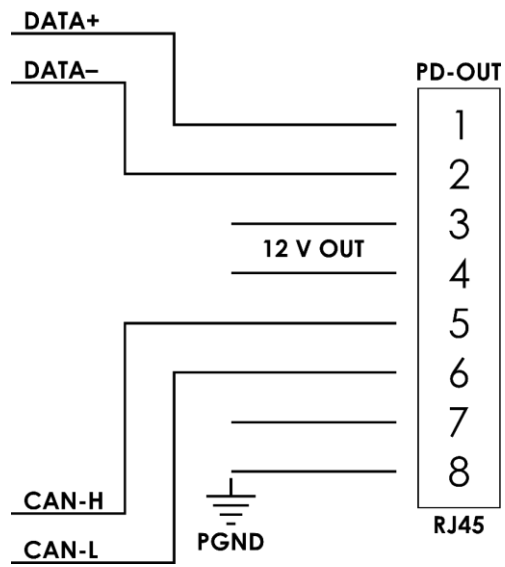

Fig. 11

6. Operation

6.1. Safety Instructions for Operation

**Attention**

This device must be used only for the purposes it is designed for.

This device is designed to be used as a professional DMX trigger/recorder. This device is not suitable for households.

Any other use, not mentioned under intended use, is regarded as non-intended and incorrect use.

**Attention****Power supply**

Before connecting the device to the power supply, make sure that the current, voltage and frequency match the input voltage, current and frequency specified on the information label on the device.

6.2. Start-up

- 01) Before you power the device, insert the included microSD card into the **slot (02)**.
- 02) Power the device up. Upon start-up, the device will show the start screen:



DMX Trigger
Recorder

- 03) Press the **MENU** button to enter the main menu. See **6.9. Main Menu Options** on page 20 for more information.
- 04) Press and hold down the **MENU** button for 2 seconds in order to return to the start screen (from any place in the menu).

Note:

If the display is off, press any button to turn the display on. See **6.9.7.3. Display Option** on page 27 for more information.

6.3. Control Panel

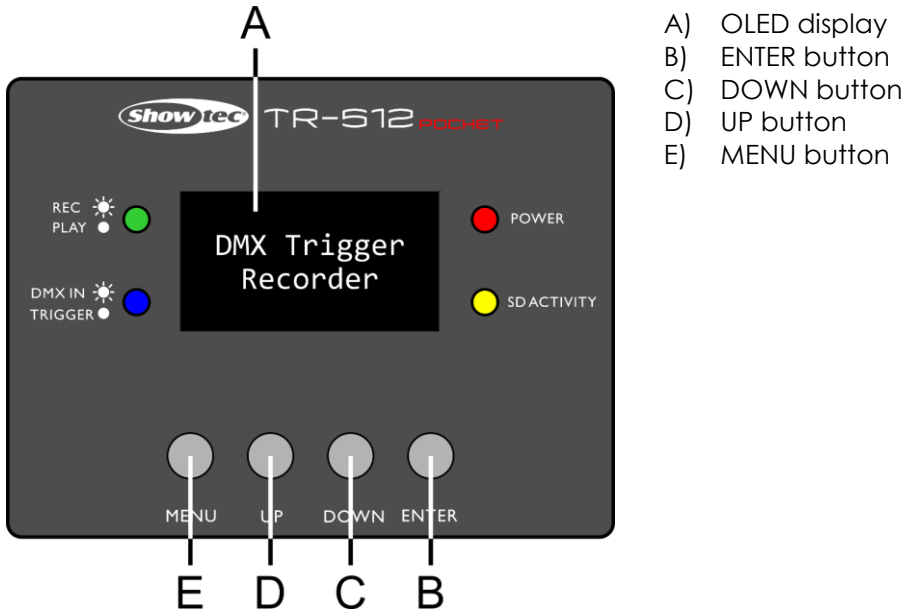

Fig. 12

- Use the **MENU** button to open the main menu, to exit the current submenu and to return to the main menu.
- Use the **UP/DOWN** buttons to navigate through the menus and to scroll through the available characters/numbers.
- Use the **ENTER** button to open the desired menu, to confirm your choice or to set the currently selected character/number.

6.4. Recording a Program

The device allows to record DMX programs and assign them to the 6 available triggers.

- 01) Connect a DMX-512 light controller and light fixtures to the device. See **5.3.1. Program Recording Setup** on page 12 for more information.
- 02) Make sure that the included microSD card is inserted into the device.
- 03) Record a program. See **6.9.2. Record Show** on page 21 for more information. During recording, the **LED indicator (11)** will be blinking. See **6.7. LED Statuses** on page 18 for more information.
- 04) When you finished recording the program, disconnect the DMX-512 light controller.

6.5. Playing a Program

The device is equipped with 6 triggers to which you can assign your recorded programs. When a trigger is activated, the program assigned to this trigger will be played.

- 01) Connect the external triggers to the device. See **5.3.2. Program Playing Setup** on page 12 for more information.
- 02) Assign the recorded program to one of the 6 triggers. See **6.9.4. Trigger Event** on page 23 for more information.
- 03) Activate DMX triggering. See **6.9.7.2. DMX Trigger Option** on page 27 for more information.
- 04) Activate the external triggers, press the buttons on the Wall Panel Remote for TR-512 Install/Pocket or operate the DMX controller. The **LED indicator (10)** will blink once, every time a trigger is activated. During playing programs, the **LED indicator (11)** will be on. See **6.7. LED Statuses** on page 18 and **6.10. DMX Channels** on page 30 for more information.

6.6. Trigger Monitoring

You can monitor the current status of each of the 6 triggers. You can access the trigger status menu only from the start screen.

- 01) Press and hold down the **MENU** button for 2 seconds in order to return to the start screen, from any place in the menu.



- 02) Repeatedly press the **UP/DOWN** buttons to see the status of each of the 6 triggers.

Trigger Status	
1.Name:	Trigger1
2.Show:	SHT001
3.Time:	00:03
4.Status:	Playing
5.Delay:	00:00

- 03) The display shows the following information:

- NAME: Trigger's name
- SHOW: Assigned DMX program's name
- TIME: Playing time
- STATUS: PLAYING (trigger is active) or WAITING (trigger is inactive)
- DELAY: Delay time

6.7. LED Statuses

There are 4 LED indicators (**Power indicator (04)**, **MicroSD indicator (05)**, **DMX IN/Trigger indicator (10)** and **Play/Record indicator (11)**) on the control panel of the device. The LED indicators have the following functions:

- POWER: If the light is on, the device is powered.
- SD ACTIVITY: If the light is on, the device is using the inserted microSD card to load/save data.
- REC/PLAY:
 - If the light is blinking, the device is recording a program.
 - If the light is on, the device is playing a program.
- DMX IN/TRIGGER:
 - If the light is blinking, the device is receiving a DMX signal.
 - If the light blinks once, a trigger is activated.

6.9. Main Menu Options

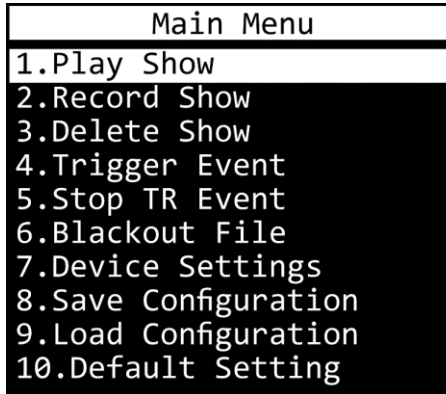

1. Play Show
2. Record Show
3. Delete Show
4. Trigger Event
5. Stop TR Event
6. Blackout File
7. Device Settings
8. Save Configuration
9. Load Configuration
10. Default Setting

- 01) Press the **UP/DOWN** buttons to toggle through the 10 menus.
- 02) Press the **ENTER** button to open the desired menu.

6.9.1. Play Show

In this menu you can play a recorded program. You can only play one program at a time.

Note:

You need to program at least one program in order to be able to play it. For more information, please read **6.9.2. Record Show**, page 21.

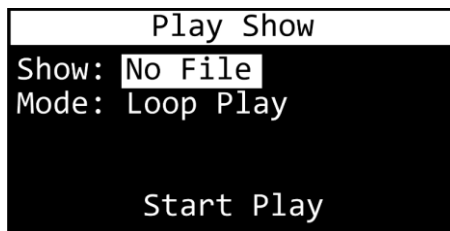

- 01) Press the **UP/DOWN** buttons to select one of the 2 submenus:
 - SHOW (See **6.9.1.1. Show** on page 20 for more information.)
 - MODE (See **6.9.1.2. Playback Mode** on page 21 for more information.)
- 02) Press the **ENTER** button to open the selected option.

6.9.1.1. Show

In this submenu you can select the desired program.

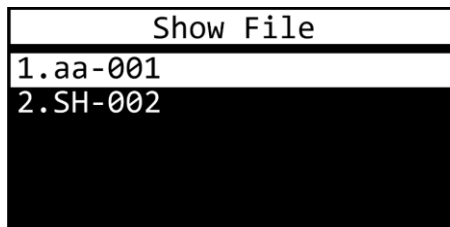

- 01) Press the **UP/DOWN** buttons to select the desired program.
- 02) Press the **ENTER** button to confirm your choice.

6.9.1.2. Playback Mode

In this submenu you can play the desired program.

- 01) Press the **UP/DOWN** buttons to select ONE PLAY (the program will be played once) or LOOP PLAY (the program will be played in a loop).
- 02) Press the **ENTER** button to confirm your choice.
- 03) Press the **UP/DOWN** buttons to select START PLAY and press the **ENTER** button. The device will now play the desired program.

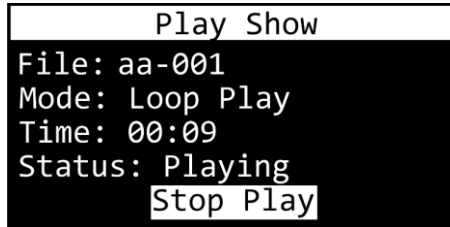

- 04) Press the **ENTER** button to stop playback.

6.9.2. Record Show

In this menu you can name and record programs.

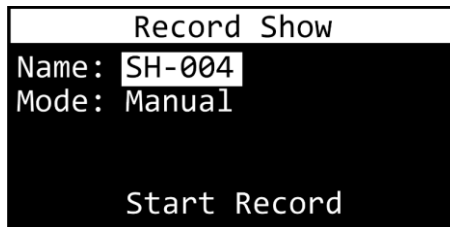

- 01) Press the **UP/DOWN** buttons to select one of the 2 submenus:
 - NAME (See **6.9.2.1. Name** on page 21 for more information.)
 - MODE (See **6.9.2.2. Record Mode** on page 22 for more information.)
- 02) Press the **ENTER** button to open the selected option.

6.9.2.1. Name

In this submenu you can name programs.

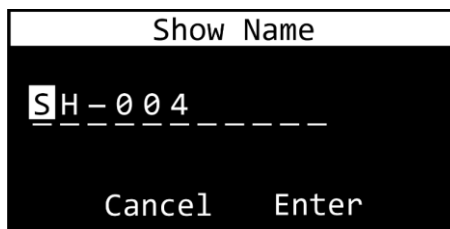

- 01) Press the **UP/DOWN** buttons to select the character you want to edit.
- 02) Press the **ENTER** button.
- 03) Press (or press and hold down, for quick search) the **UP/DOWN** buttons to select the desired character.
- 04) Press the **ENTER** button to confirm your choice.
- 05) Repeat steps 1–4 to edit the remaining characters.
- 06) Press the **UP/DOWN** buttons to select CANCEL (to cancel changes) or ENTER (to save the new file name).
- 07) Press the **ENTER** button to confirm your choice.

6.9.2.2. Record Mode

In this submenu you can set recording options.

- 01) Press the **ENTER** button to open the menu.
- 02) Press the **UP/DOWN** buttons to select one of the 4 recording modes:
 - **MANUAL:** Start and stop recording manually.
 - **AUTO_START:** Start recording by setting all DMX channel values higher than 0 or deactivate Blackout on the light controller. Stop recording manually.
 - **AUTO_STOP:** Start recording manually. Stop recording by setting all DMX channel values to 0 or activate Blackout on the light controller.
 - **AUTO:** Recording starts when the value of a DMX channel is higher than 0. Stop recording by setting all DMX channel values to 0 or activate Blackout on the light controller.
- 03) Press the **ENTER** button to confirm your choice.
- 04) Press the **UP/DOWN** buttons to select START RECORD.
- 05) Press the **ENTER** button to confirm.
- 06) If the display shows WAITING START, press the **ENTER** button again to start recording.
- 07) Press the **ENTER** button to stop recording. The recorded program will be saved.

6.9.3. Delete Show

In this menu you can remove the previously recorded programs.

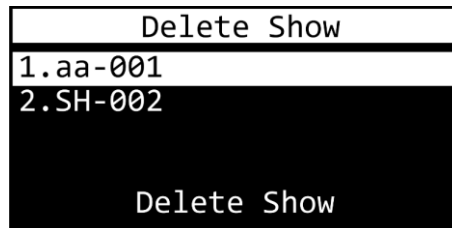

- 01) Press the **UP/DOWN** buttons to select the program you want to delete.
- 02) Press the **ENTER** button to confirm your choice. DELETE SHOW will illuminate.
- 03) Press the **ENTER** button to delete the program.
- 04) Repeat steps 1–3 to delete other programs.

If the program that you want to delete is assigned to any active trigger event, the device will display a message.

- 05) Press the **UP/DOWN** buttons to choose CONTINUE (to delete the program) or RETURN (to return to the previous menu)
- 06) Press the **ENTER** button to confirm your choice.

6.9.4. Trigger Event

In this menu you can set the trigger event settings.

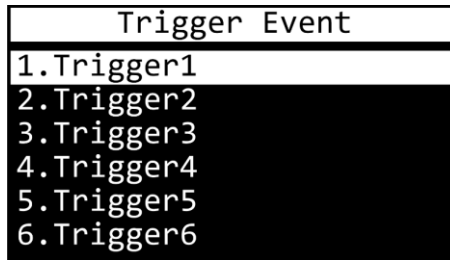

- 01) Press the **UP/DOWN** buttons to select the desired trigger.
- 02) Press the **ENTER** button to open the desired trigger's menu. The display will show:

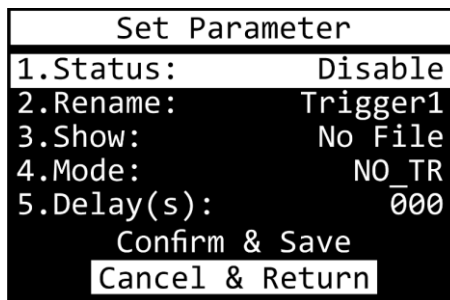

- 03) Press the **UP/DOWN** buttons to toggle through the 5 available submenus:
 - STATUS (See **6.9.4.1. Status** on page 23 for more information.)
 - RENAME (See **6.9.4.2. Rename** on page 23 for more information.)
 - SHOW (See **6.9.4.3. Show** on page 24 for more information.)
 - MODE (See **6.9.4.4. Trigger Mode** on page 24 for more information.)
 - DELAY (See **6.9.4.5. Delay** on page 24 for more information.)
- 04) Press the **ENTER** button to open the desired submenu.

Once you have adjusted all the options in menus **6.9.4.1–6.9.4.5**, save your trigger event.

- 05) Press the **UP/DOWN** buttons to select CONFIRM & SAVE (to save a new trigger event) or CANCEL & RETURN (to cancel changes and return to the previous menu).
- 06) Press the **ENTER** button to confirm your choice.

6.9.4.1. Status

In this submenu you can activate/deactivate the desired trigger event.

- 01) Press the **UP/DOWN** buttons to select ENABLE or DISABLE.
- 02) Press the **ENTER** button to confirm your choice.

6.9.4.2. Rename

In this submenu you can rename the trigger events.

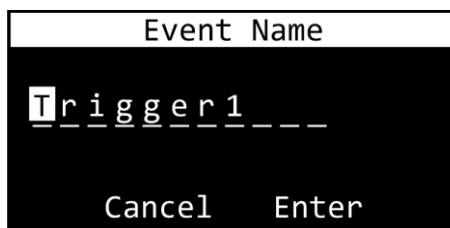

- 01) Press the **UP/DOWN** buttons to select the character you want to edit.
- 02) Press the **ENTER** button.

- 03) Press (or press and hold down, for quick search) the **UP/DOWN** buttons to select the desired character.
- 04) Press the **ENTER** button to confirm your choice.
- 05) Repeat steps 1–4 to edit the remaining characters.
- 06) Press the **UP/DOWN** buttons to select CANCEL (to cancel changes) or ENTER (to save the new name).
- 07) Press the **ENTER** button to confirm your choice.

6.9.4.3. Show

In this submenu you can assign your recorded programs to the desired triggers.

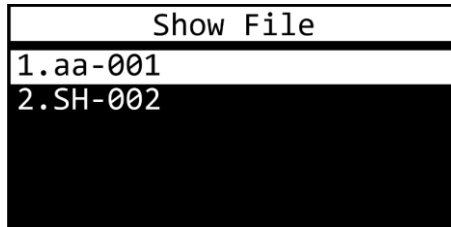

- 01) Press the **UP/DOWN** buttons to select the desired program from the list.
- 02) Press the **ENTER** button to confirm your choice.

6.9.4.4. Trigger Mode

In this submenu you can set the trigger mode.

- 01) Press the **UP/DOWN** buttons to select one of the 4 trigger modes:
 - **NO_TR** (Normally Open): Trigger will be activated when the circuit closes. As long as the circuit remains closed, the triggered program will play in a loop. When the circuit opens, the program will keep playing until it ends and then it will stop. With only a short pulse, the program will play just once.
 - **NC_TR** (Normally Closed): Trigger will be activated when the circuit opens. As long as the circuit remains open, the triggered program will play in a loop. When the circuit closes, the program will keep playing until it ends and then it will stop. With only a short pulse, the program will play just once.
 - **TOGGLE_TR**: It works with NO and NC circuits (external triggers). The first pulse starts the triggered program to play in a loop. After the second pulse, the program will stop. Another pulse will restart the program.
 - **AUTO_TR**: The trigger will be activated immediately. Upon every start-up, the device will always search for any triggers set to this mode and will activate them.
- 02) Press the **ENTER** button to confirm your choice.

Note:

It is possible to use each of the 4 modes at the same time, independently, for separate triggers (1-6).

6.9.4.5. Delay

In this submenu you can set the delay time.

- 01) Press the **UP/DOWN** buttons to set the delay time. The adjustment range is 0–120 seconds.
- 02) Press the **ENTER** button to save changes.

6.9.5. Stop TR Event

In this menu you can deactivate the trigger events.

Stop TR Event	
1.Trigger1:	Playing
2.Trigger2:	Playing
3.Trigger3:	Stop
4.Trigger4:	Stop
5.Trigger5:	Stop
6.Trigger6:	Stop

- 01) Press the **UP/DOWN** buttons to select one of the 6 trigger events.
- 02) Press the **ENTER** button to deactivate the selected trigger event.
- 03) Repeat steps 1–2 to deactivate the remaining trigger events, if needed.

6.9.6. Blackout File

In this menu you can set a blackout file.

Normally, when a show playback is finished, all DMX channels are set to 0 (default blackout). In other words, the device plays back a scene in which all DMX values are 0. If all your programmed shows use the same starting and ending positions/colors, it is not always convenient or necessary for the light fixtures to zero all their DMX settings after each show.

To prevent it, you can record a short show with the desired starting/ending settings and set it as your blackout file. The device will read only the first scene of this show, so it does not need to be longer than 1 second.

The device will now use your settings, instead of the default blackout, which will create smooth transitions between the shows.

Note:

You need to record a show to be able to use it as a blackout file. For more information, please read **6.9.2. Record Show**, page 21.

Blackout File	
Show:	No File
Clear File	

- 01) Press the **UP/DOWN** buttons to select SHOW.
- 02) Press the **ENTER** button to open the submenu. The display will show:

Show File	
1.	aa-001
2.	SH-002

- 03) Press the **UP/DOWN** buttons to select the desired show.

04) Press the **ENTER** button to confirm your choice. The display will show:

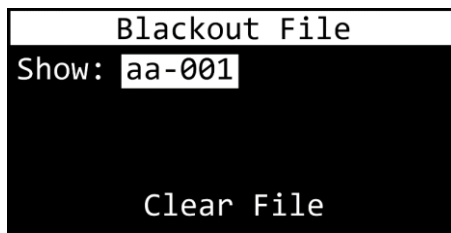

The blackout file is set and will be played between your shows.

If you do not need the blackout file anymore and want to use the default blackout, you need to uninstall the blackout file.

05) Press the **UP/DOWN** buttons to select CLEAR FILE and press the **ENTER** button to confirm. The device will now use the default blackout.

6.9.7. Device Settings

In this menu you can adjust the device's settings.

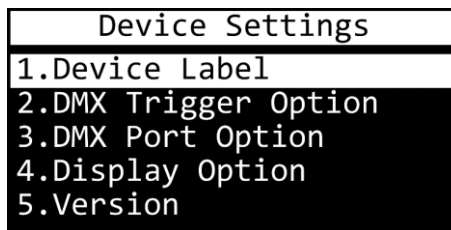

01) Press the **UP/DOWN** buttons to toggle through the 5 available submenus:

- DEVICE LABEL (See **6.9.7.1. Device Label** on page 26 for more information.)
- DMX TRIGGER OPTION (See **6.9.7.2. DMX Trigger Option** on page 27 for more information.)
- DMX PORT OPTION (See **6.9.7.3. DMX Port Option** on page 27 for more information.)
- DISPLAY OPTION (See **6.9.7.4. Display Option** on page 28 for more information.)
- VERSION (See **6.9.7.5. Version** on page 28 for more information.)

02) Press the **ENTER** button to open the desired submenu.

6.9.7.1. Device Label

In this submenu you can rename the device label.



01) Press the **UP/DOWN** buttons to select the character you want to edit.

02) Press the **ENTER** button.

03) Press (or press and hold down, for quick search) the **UP/DOWN** buttons to select the desired character.

04) Press the **ENTER** button to confirm your choice.

05) Repeat steps 1–4 to edit the remaining characters.

06) Press the **UP/DOWN** buttons to select CANCEL (to cancel changes) or ENTER (to save the new name).

07) Press the **ENTER** button to confirm your choice.

6.9.7.2. DMX Trigger Option

In this submenu you can activate DMX control. You can use a DMX controller to activate the desired trigger events (1–6). Each trigger event can be started by setting corresponding DMX values.

DMX Trigger Option	
1.Trigger:	ENABLE
2.DMX Address:	001

- 01) Press the **UP/DOWN** buttons to select TRIGGER.
- 02) Press the **ENTER** button to open the menu.
- 03) Press the **UP/DOWN** buttons to select one of the 2 options:
 - **ENABLE:** Activates the function. Use a DMX controller to activate the desired trigger events.
 - **DISABLE:** Deactivates the function.
- 04) Press the **ENTER** button to confirm your choice.
- 05) Press the **UP/DOWN** buttons to select DMX ADDRESS.
- 06) Press the **ENTER** button to open the menu.
- 07) Press the **UP/DOWN** buttons to select a DMX starting address that will be used for trigger event activation. The adjustment range is 001–512. See **6.10. DMX Channels** on page 30 for more information.
- 08) Press the **ENTER** button to confirm your choice.

6.9.7.3. DMX Port Option

In this submenu you can adjust the port settings.

DMX Port Option	
1.Output Mode:	Single

- 01) Press the **ENTER** button to open the menu.
- 02) Press the **UP/DOWN** buttons to select one of the 2 output modes:
 - **SINGLE:** Only the last triggered program will be played.
 - **HTP (Highest Takes Precedence):** All triggered programs can be played simultaneously. The DMX values of each DMX channel are compared for all the triggered programs and they become merged into a DMX output signal, which contains only the highest value for each DMX channel.
- 03) Press the **ENTER** button to confirm your choice.

6.9.7.4. Display Option

In this submenu you can set the display options.

Display Option	
1.Mode:	Normal
2.GoBack(s):	25
3.BackLight(s):	30

01) Press the **UP/DOWN** buttons to select one of the 3 display modes:

- **MODE:** Choose between NORMAL (normal view) and INVERSE (display flip). If you choose INVERSE, the button functions (**MENU/UP/DOWN/ENTER**) flip accordingly.
- **GOBACK(S):** Set the time after which the display returns to the start screen, when no button is pressed. The adjustment range is between NEVER and 5–60 seconds, in increments of 5 seconds.
- **BACKLIGHT(S):** Set the time which needs to pass, after which the display turns off. The adjustment range is between ON and 5–60 seconds, in increments of 5 seconds.

02) Press the **ENTER** button to open the desired submenu.

03) Press the **UP/DOWN** buttons to adjust settings.

04) Press the **ENTER** button to save changes.

6.9.7.5. Version

In this submenu you can view the current software version.

Version
CPU1:B1.0 V1.4

6.9.8. Save Configuration

In this menu you can create a backup of the device's settings. It will be saved on the microSD card.

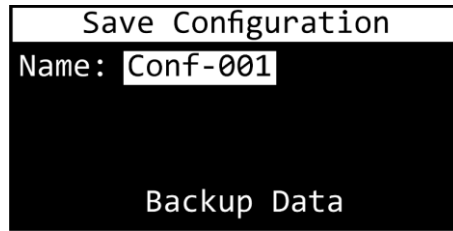

01) Press the **UP/DOWN** buttons to select NAME and press the **ENTER** button to edit the backup's name.



02) Press the **UP/DOWN** buttons to select the character you want to edit.

03) Press the **ENTER** button.

04) Press (or press and hold down, for quick search) the **UP/DOWN** buttons to select the desired character.

05) Press the **ENTER** button to confirm your choice.

06) Repeat steps 1–5 to edit the remaining characters.

07) Press the **UP/DOWN** buttons to select CANCEL (to cancel changes) or ENTER (to save the new name).

08) Press the **ENTER** button to confirm your choice.

09) Press the **UP/DOWN** buttons to select BACKUP DATA.

10) Press the **ENTER** button to create a configuration backup.

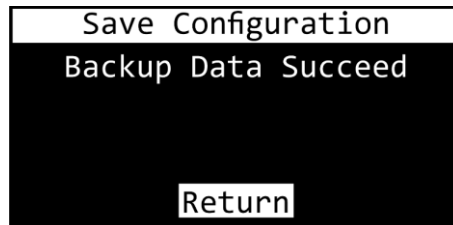

11) Press the **ENTER** button to return to the main menu.

6.9.9. Load Configuration

In this menu you can load or delete your configuration backup files.

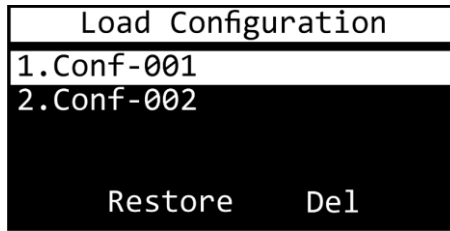

- 01) Press the **UP/DOWN** buttons to select the desired configuration backup file.
- 02) Press the **ENTER** button to confirm your choice.
- 03) Press the **UP/DOWN** buttons to choose between RESTORE (load the desired configuration backup file) and DEL (delete the desired configuration backup file).
- 04) Press the **ENTER** button to confirm your choice or press the **MENU** button if you do not want to use those functions and you want to return to the previous menu.

6.9.10. Default Setting

In this menu you can restore default factory settings.

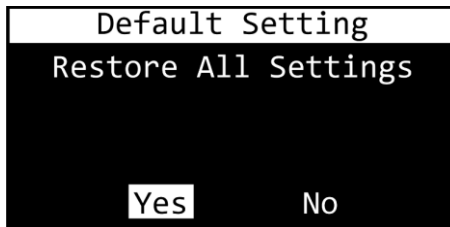

- 01) Press the **UP/DOWN** button to choose between the 2 options:
 - YES: The default factory settings will be restored. All settings of the current trigger events and all the display options will be set to default. The DMX PORT OPTION will be set to SINGLE. All saved programs and configuration files will not be reset.
 - NO: The device will return to the main menu.
- 02) Press the **ENTER** button to confirm your choice. The display will return to the main menu.

Note:

Turn the TR-512 Pocket off before removing the microSD card. Use the included microSD card to back up your data and transfer your files to a regular PC.

6.10. DMX Channels

Value	Setting
000-010	Stop trigger events
011-050	Run trigger event 1
051-090	Run trigger event 2
091-130	Run trigger event 3
131-170	Run trigger event 4
171-210	Run trigger event 5
211-251	Run trigger event 6
252-255	Stop trigger events

7. Troubleshooting

This troubleshooting guide contains solutions to problems which can be carried out by an ordinary person. The device does not contain user-serviceable parts.

Unauthorized modifications to the device will render the warranty void. Such modifications may result in injuries and material damage.

Refer servicing to instructed or skilled persons. Contact your Highlite International dealer in case the solution is not described in the table.

Problem	Probable cause(s)	Solution
The device does not function at all	No power to the device	<ul style="list-style-type: none"> • Check if power is switched on and cables are plugged in • Check if the external power supply is connected properly and if it is operating within its specification limits
No DMX data transfer	The factory settings of the device are changed	<ul style="list-style-type: none"> • Reset the device's parameters to the default factory settings. See 6.9.10. Default Setting on page 30
	Bad data link connection	<ul style="list-style-type: none"> • Examine connections and cables. Correct poor connections. Repair or replace damaged cables
	The signal is reversed. The DMX OUT of the controller does not match the DMX IN of the device	<ul style="list-style-type: none"> • Install a phase-reversing cable between the controller and the device

8. Maintenance

Maintenance and cleaning shall be carried out only by instructed persons. Follow the maintenance schedule established for the site where the electrical enclosure is installed.

Disconnect power supply before servicing or cleaning.

8.1. Preventive Maintenance



Attention
Before use, examine the device visually for any defects.

Make sure that:

- All screws used for installing the device or parts of the device are tightly fastened and are not corroded.
- There are no deformations on housings, fixations and installation points.
- The power cables are not damaged and do not show any material fatigue.

8.1.1. Basic Cleaning Instructions

To clean the device, follow the steps below:

- 01) Disconnect the electrical enclosure from the power supply.
- 02) Clean the device with a soft, lint-free cloth.
- 03) Remove residual dust with an air-duster or air-blower. Keep the air-duster or air-blower at a minimum distance of 30 cm.



Attention

- Do not immerse the device in liquid.
- Do not use alcohol or solvents.
- Do not clean the device with a brush.

8.2. Corrective Maintenance

The device does not contain user-serviceable parts. Do not open the device and do not modify the device.

Refer repairs and servicing to instructed or skilled persons. Contact your Highlite International dealer for more information.

9. Deinstallation, Transportation and Storage

- Disconnect the electrical enclosure, where the device is mounted, from the power supply before deinstallation of the device.
- Use the original packaging to transport the device, if possible.
- Clean the device before storing. Follow the cleaning instructions in chapter **8.1.1. Basic Cleaning Instructions** on page 31.
- Store the device in the original packaging, if possible.

10. Disposal

Correct disposal of this product

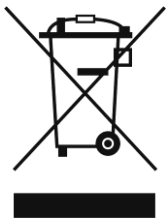

Waste Electrical and Electronic Equipment

This symbol on the product, its packaging or documents indicates that the product shall not be treated as household waste. Dispose of this product by handing it to the respective collection point for recycling of electrical and electronic equipment. This is to avoid environmental damage or personal injury due to uncontrolled waste disposal. For more detailed information about recycling of this product contact the local authorities or the authorized dealer.

11. Approval



Check the respective product page on the website of Highlite International (www.highlite.com) for an available declaration of conformity.



©2021 Showtec