



NSCaster X1

User Manual

REV 1.2

**Copyright © 2006-2021 NANJING NAGASOFT CORPORATION
All rights reserved**

www.nagasoftsales.org

Table of Contents

1 HARDWARE SPECIFICATION	1
1.1 LIST ACCESSORIES	1
1.2 DEVICE PARAMETERS	1
1.3 MODEL	2
1.4 INTERFACE DIAGRAM	2
1.4.1 Back Interface	2
1.4.2 Side Interface	4
1.4.3 Bottom interface	4
2 INSTALLATION AND COMMISSIONING	5
3 SOFTWARE FEATURES	8
3.1 NSCASTER-X1 MAIN INTERFACE	8
3.1.1 PGM	8
3.1.2 SDI/HDMI Channel	9
3.1.3 NET Channel	14
3.1.4 DDR Channel	17
3.1.5 Image Overlay	18
3.1.6 PIP (Picture in Picture)	20
3.1.7 Scoreboard	21
3.1.8 Audio Mixer	22
3.1.9 Subtitle	23
3.1.10 CG	25
3.1.11 PTZ control	28
3.1.12 Special Effects	28
3.2 NSCASTER-X1 SETTINGS INTERFACE	29
3.2.1 Channel Recording	29
3.2.2 Recording	30
3.2.3 Streaming	31
3.2.4 NDI HX Output	36
3.2.5 Audio Settings	37
3.2.6 OSD Settings	38
3.2.7 Network	39
3.2.8 Live+	44
3.2.9 File Transfer	45
3.2.10 FTP Upload	47
3.2.11 General Settings	47
3.2.12 About	49
4 QUESTIONS AND ANSWERS	50
5 APPENDIX	52
5.1 YOUTUBE LIVE SETTINGS	52
5.2 FACEBOOK LIVE SETTINGS	60
5.3 CG EDITOR OPERATION	62
5.3.1 Interface	62
5.3.2 Remote Publishing	63
5.3.3 CG Page	64
5.3.4 CG Element	66
5.3.5 System Settings	71

1 Hardware Specification

1.1 List Accessories

Name/Model	Package	Specification	Number of Pieces	Actual Quantity	Remarks
Main device	Aluminum box packaging	NSCasterX1	1	1	
Power supply and power cord	Aluminum box packaging	Standard	1	1	
WIFI antenna	Aluminum box packaging	Standard	1	1	
4G antenna	Aluminum box packaging	Standard	2	2	Standard Version
4G antenna	Aluminum box packaging	Standard	3	3	4G Bonding Version
Image Transmission antenna	Aluminum box packaging	Standard	4	4	Wireless Image Transmitter Version
User manual	Aluminum box packaging	Nagasoft Custom	1	1	e-edition
Warranty card certificate	Aluminum box packaging	Nagasoft Custom	1	1	

1.2 Device Parameters

Device Item Name	Description
Chassis	Portable case, built-in with 11.6-inch high-definition touch screen
Dimensions	294mm*193mm*54mm (W x H x D)
Weight	1.25KG
Powered by	100~240V AC
Transport box	Aluminium box packaging
Operating temperature	-10-50°C
Storage temperature	-20-70°C
Operating humidity	10~90% no condensation
Impact resistance	15g
Vibration resistance	10-100Hz 1.25g
Altitude	Below 4000 meters

1.3 Model



Standard Version



4G Bonding Version



Wireless Image Transmitter Version

1.4 Interface Diagram

1.4.1 Back Interface

1) The back interface of the standard version is shown below:

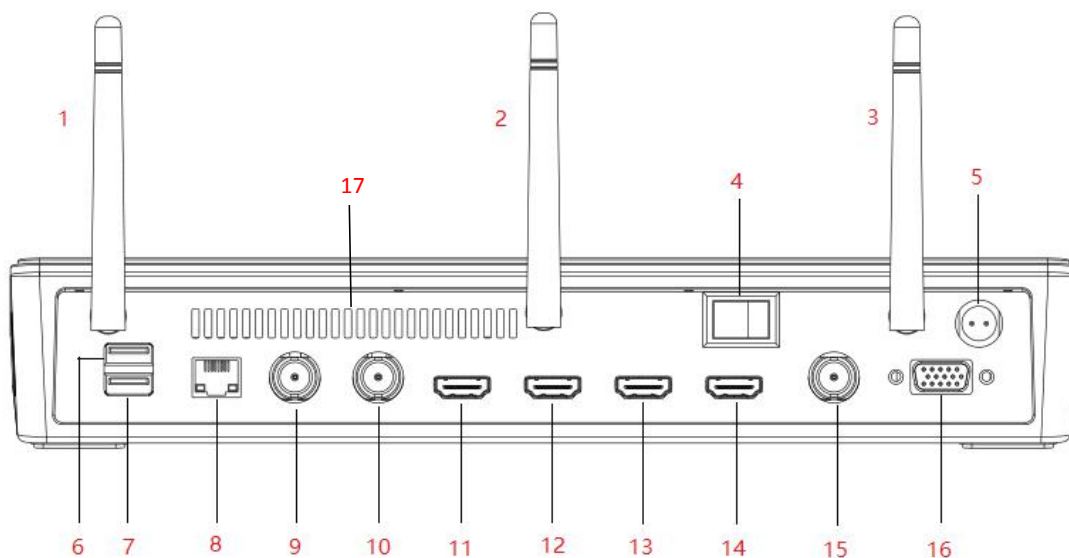

1	4G antenna	7	USB3.0	13	HDMI Display interface
2	4G antenna	8	Gigabit Ethernet port	14	HDMI PGM Output
3	WIFI antenna	9	SDI-1 Input	15	SDI PGM Output
4	Switch	10	SDI-2 Input	16	TALLY
5	Power supply (DC 19V)	11	HDMI-1 Input	17	Cooling port
6	USB2.0	12	HDMI-2 Input		

2) The back interface of the 4G bonding version is shown below:

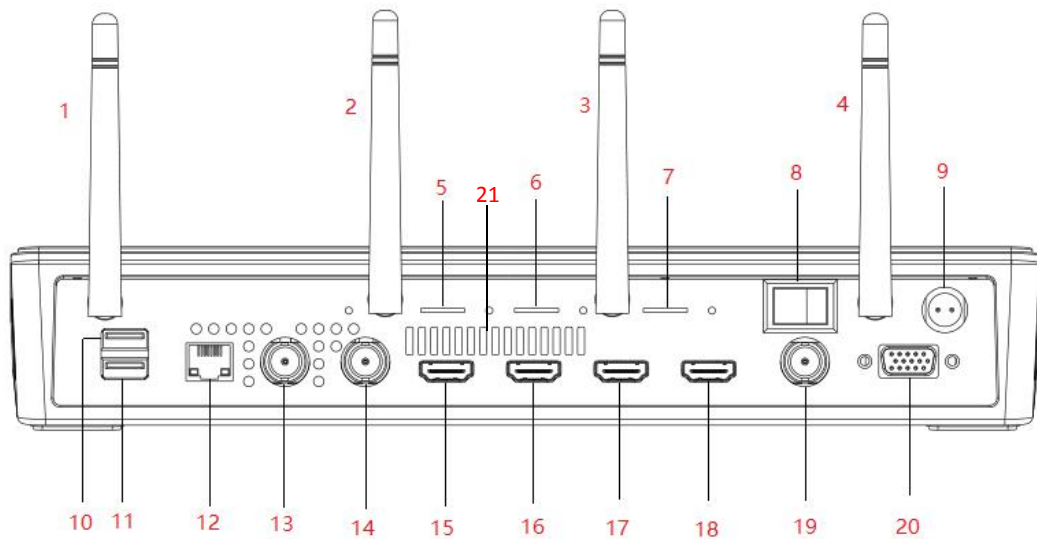

1	4G antenna	8	Switch	15	HDMI-1 Input
2	4G antenna	9	Power supply (DC 19V)	16	HDMI-2 Input
3	4G antenna	10	USB2.0	17	HDMI Display Interface
4	WIFI antenna	11	USB3.0	18	HDMI PGM Output
5	SIM1 card holder	12	Gigabit Ethernet port	19	SDI PGM Output
6	SIM2 card holder	13	SDI-1 Input	20	TALLY
7	SIM3 card holder	14	SDI-2 Input	21	Cooling port

3) The back interface of the Wireless Image Transmitter Version is shown below:

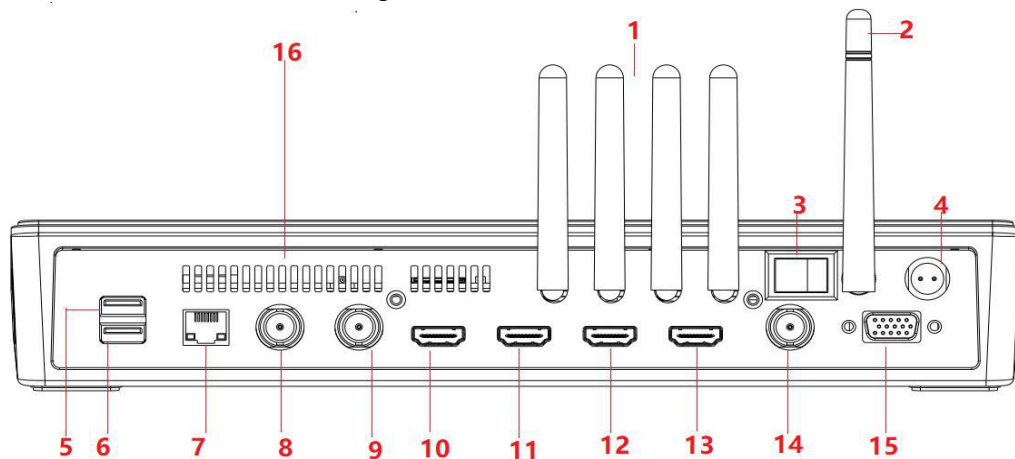

1	Image transmission antenna	7	Gigabit Ethernet port	13	HDMI PGM Output
2	WIFI antenna	8	SDI-1 Input	14	SDI PGM Output
3	Switch	9	SDI-2 Input	15	TALLY
4	Power Supply (DC 19V)	10	HDMI-1 Input	16	Cooling port
5	USB2.0	11	HDMI-2 Input		
6	USB3.0	12	HDMI Display Interface		

1.4.2 Side Interface

The side interface for both standard version and 4G bonding version are the same as shown below:

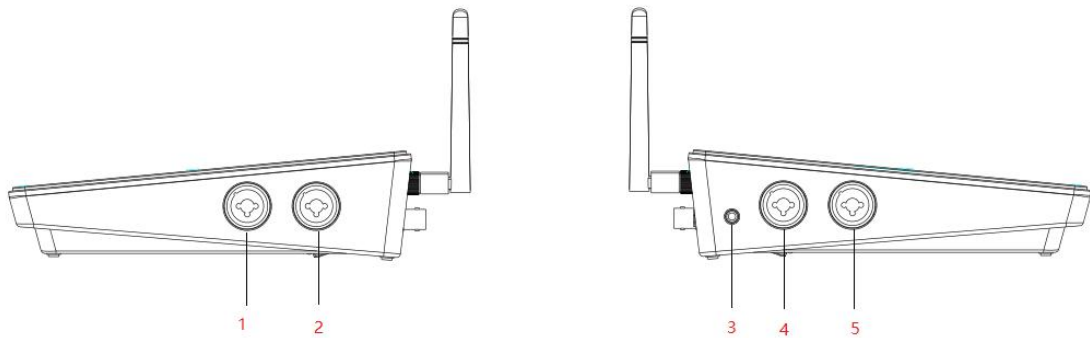

1	XLR/TRS balanced input L	4	XLR/TRS balanced output L
2	XLR/TRS balanced input R	5	XLR/TRS balanced output R
3	3.5mm monitor		

1.4.3 Bottom interface

1) The bottom interface of the standard version is shown below:

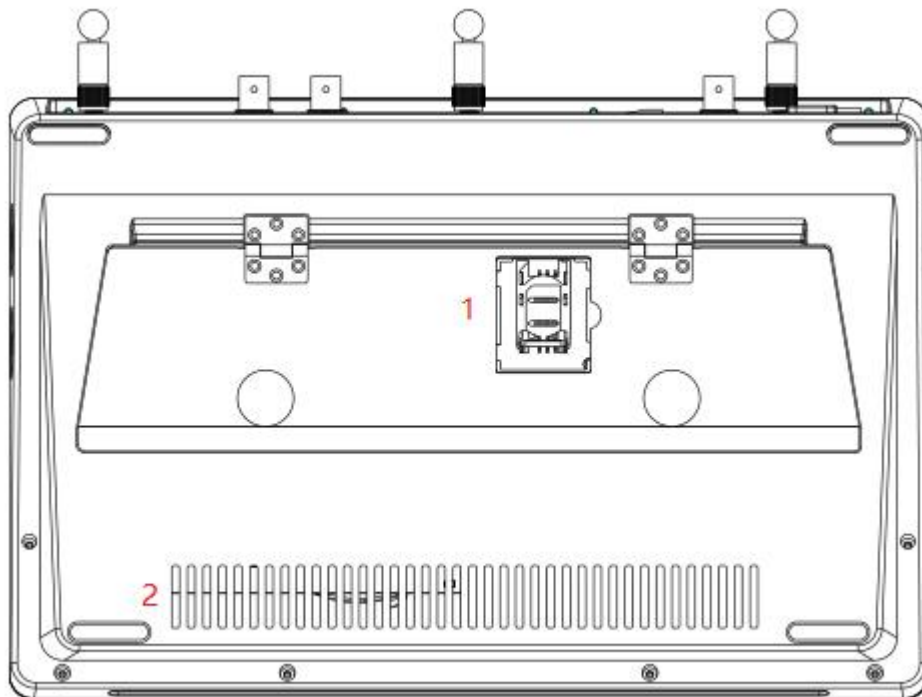

1	SIM card holder	2	Inlet
---	-----------------	---	-------

The bottom interface of the 4G bonding version/Wireless Image Transmitter version is shown below:

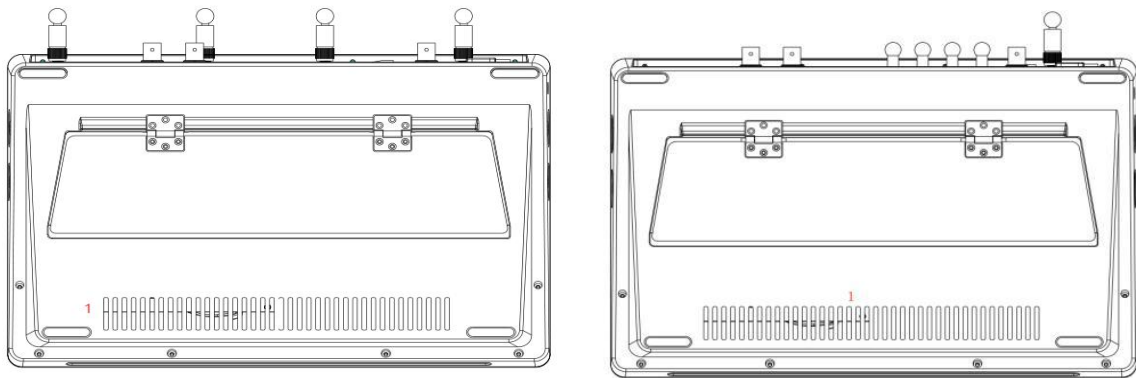

1	Inlet
---	-------

2 Installation and Commissioning

- 1) Open the box, then take out the power cord and NSCaster-X1 device. After that, lay the device on a stable surface.
- 2) Connect the power cord and the corresponding WIFI and 4G antennas. Then, use a network cable to connect to the RJ45 Gigabit Ethernet port, or insert a 4G card.
- 3) Connect the output of the AV equipment (such as camera) to the NSCaster-X1 device input interface.

- The SDI/HDMI camera is connected to the SDI/HDMI input via SDI/HDMI cable as shown below:



- The mixer is connected to the TRS MIC input port through the TRS cable, or the XLR cable is connected to the XLR input as shown below:

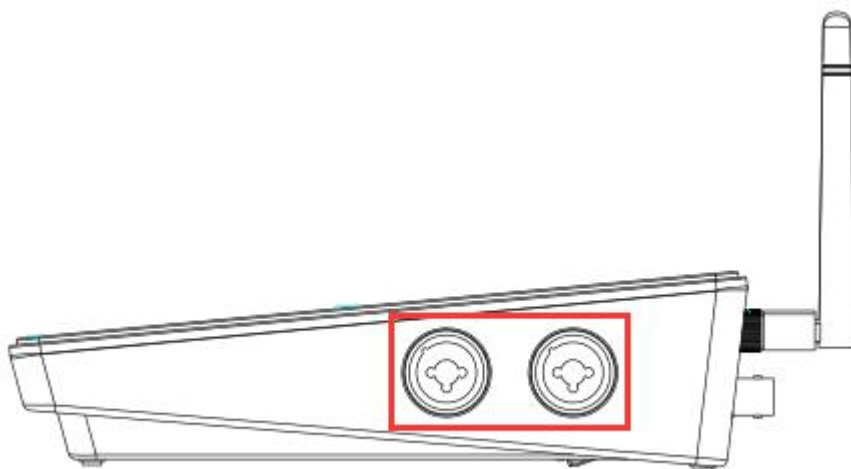

- 4) In order to connect the NSCaster-X1 device output port to the monitor, it has divided into following categories:

- The SDI monitor is connected to the SDI output via an SDI cable.



- The HDMI monitor is connected to the HDMI output via HDMI cable.



- 5) Connect the sound output of the NSCaster-X1 device to an external device or monitor.
- Connect to the TRS MIC output through the TRS cable, or connect to the XLR output interface through the XLR cable as shown below:

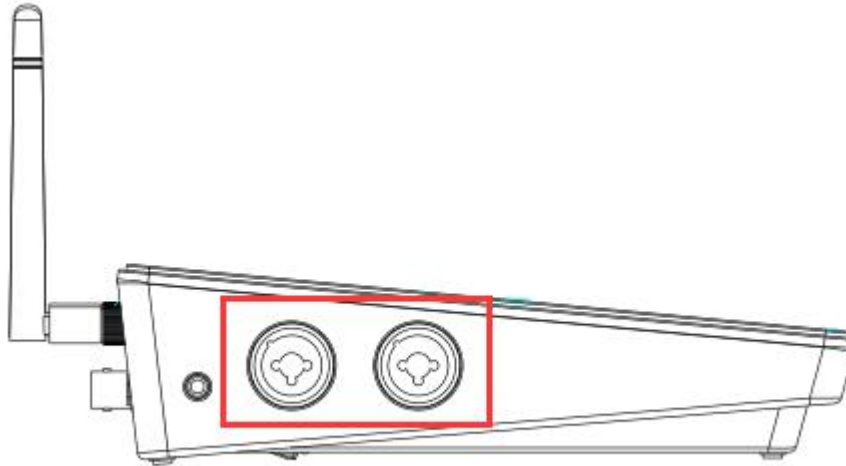

- Connect to the call output interface through a 3.5mm audio cable as shown below:

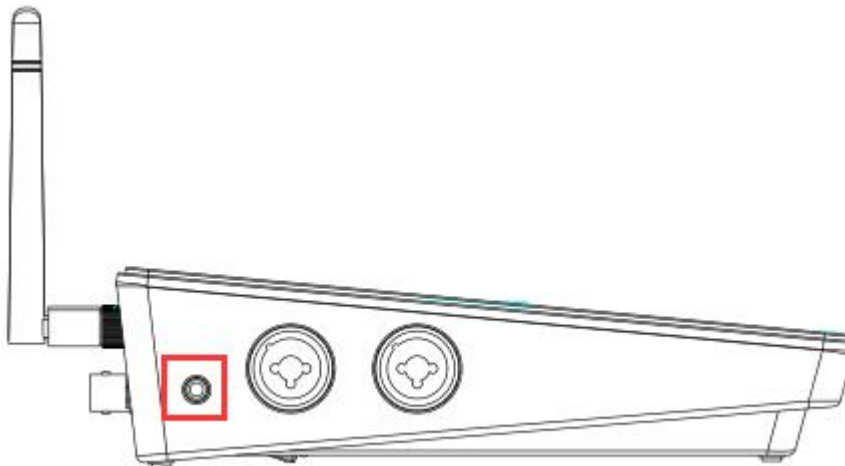

- 6) To start the NSCaster-X1 device, just press the power button on the NSCaster-X1 device as shown below:

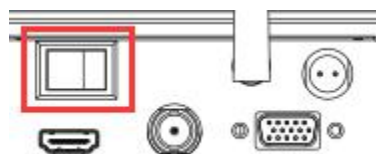

- 7) After the NSCaster-X1 device is started, it will enter the main interface of NSCaster-X1 as shown in the following figure:

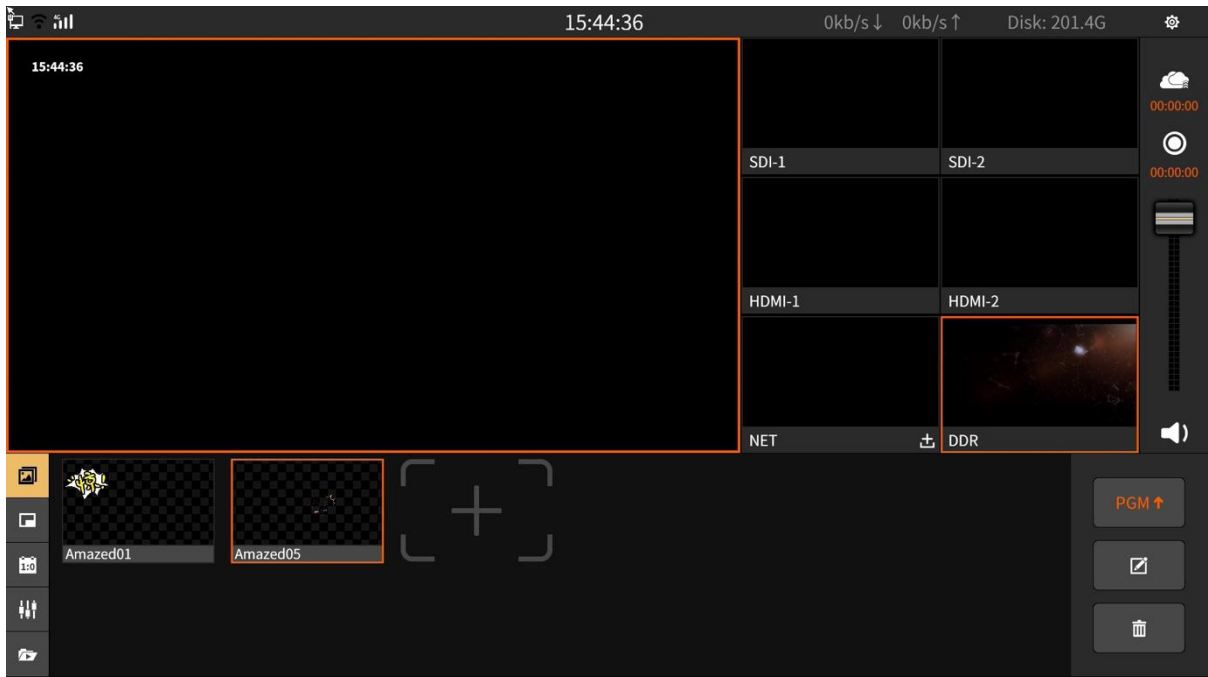

- 8) The SDI video signal and HDMI video signal are directly loaded into the main interface.
- 9) To load NET signal, select " " in the NET channel and enter the stream in the pop-up stream edit box.
- 10) To load DDR signal, select the DDR button in the DDR alternate video window, and select one of the video sources, then click Play to load the video into the DDR channel.
- 11) Select the output channel and press the record button " " to start record.
- 12) To start switching, tap once on the channel you want (SDI-1,SDI-2,HDMI-1,HDMI-2,NET,DDR) and it will switch to PGM.
- 13) Start uploading the picture on PGM as shown below:



- 14) Press again the record button to stop recording.
- 15) Check whether all the recording files are normal. The recording file is saved in the "Recording" folder which located at the "File Transfer" interface.
- 16) Press the Power On/Off button to turn off the NSCaster-X1 device.
- 17) Turn off the power switch of the device, unplug the power supply, and unplug all input and output video cables and antennas, then keep the NSCaster-X1 device properly.

3 Software Features

3.1 NSCaster-X1 Main Interface

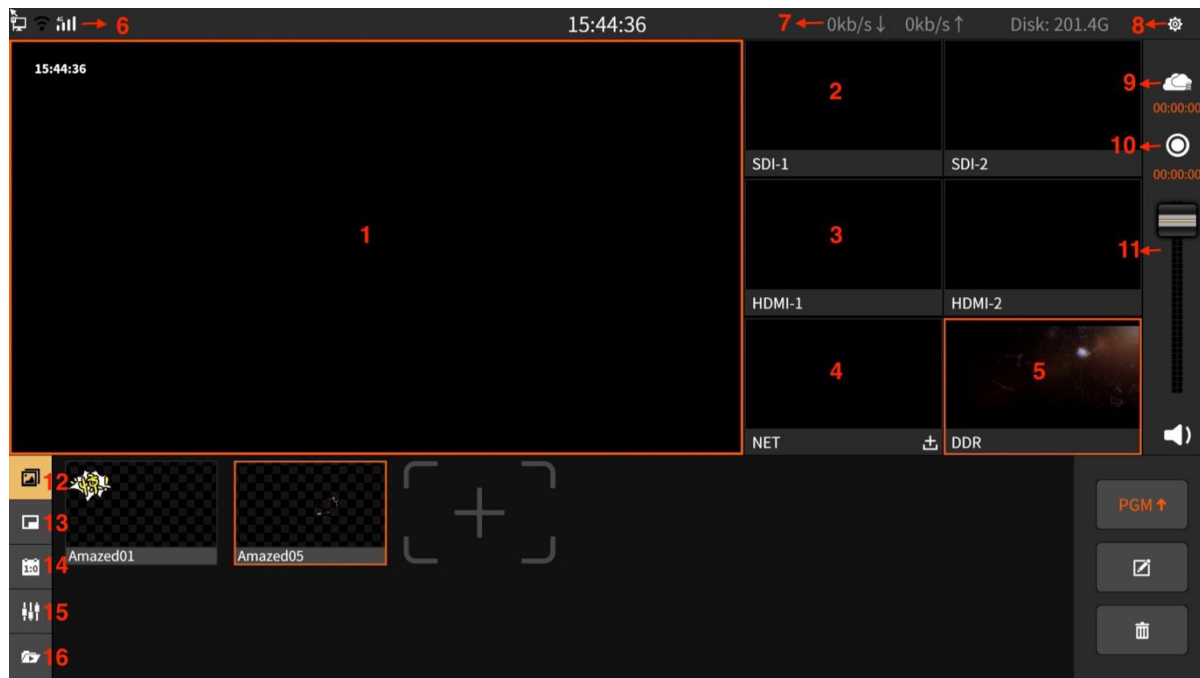

NO	Name	NO	Name
1	PGM	9	Streaming control
2	SDI input channel	10	Recording control
3	HDMI input channel	11	Tuning control for total mix output
4	NET input channel	12	Image overlay
5	DDR display channel	13	PIP (Picture in picture)
6	Network status display	14	Scoreboard
7	Resource usage monitoring status	15	Audio mixer
8	Settings button	16	DDR

Note: Drag the column on the left for subtitle, CG and transition effects function.

3.1.1 PGM

PGM channel: Monitor the screen that being broadcast. Single tap on the channel you want (SDI-1,SDI-2,HDMI-1,HDMI-2,NET,DDR) and it will switch to PGM as shown below:

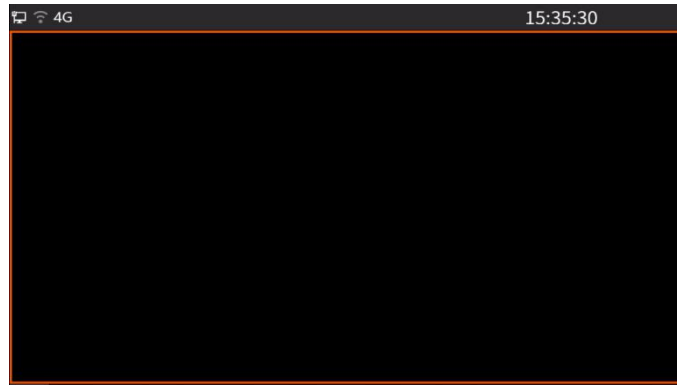

3.1.2 SDI/HDMI Channel

In addition to access to SDI/HDMI cameras or other SDI/HDMI interface devices, the first four channels can also be connected to IP cameras, Live+ devices, and network streams. Click the + icon to pop up the settings interface, as described in detail below:

1. Physical Input

Load the video and audio signals of the input interface into the corresponding channels, as shown in the following figure:

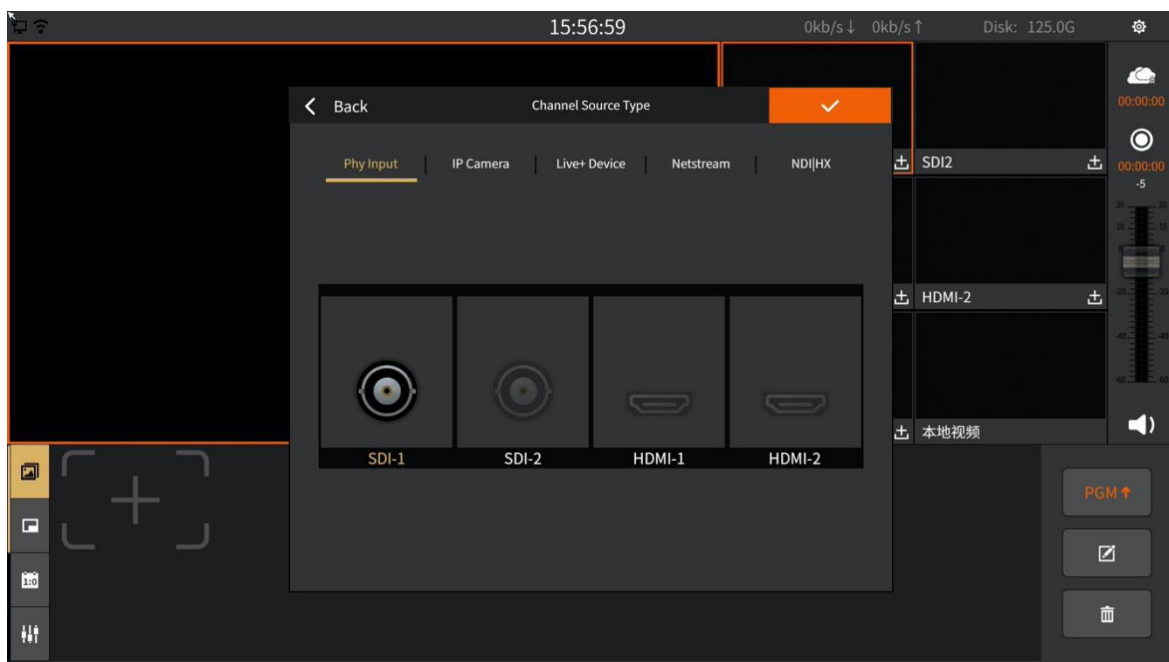

2. IP Camera

It supports two methods to add cameras by onvif, automatic discovery and manual input. It also supports editing camera parameters and deleting existing cameras. Select the IP camera that has been added in the list, click the "√" icon to confirm the selection, and the setting interface is as follows:

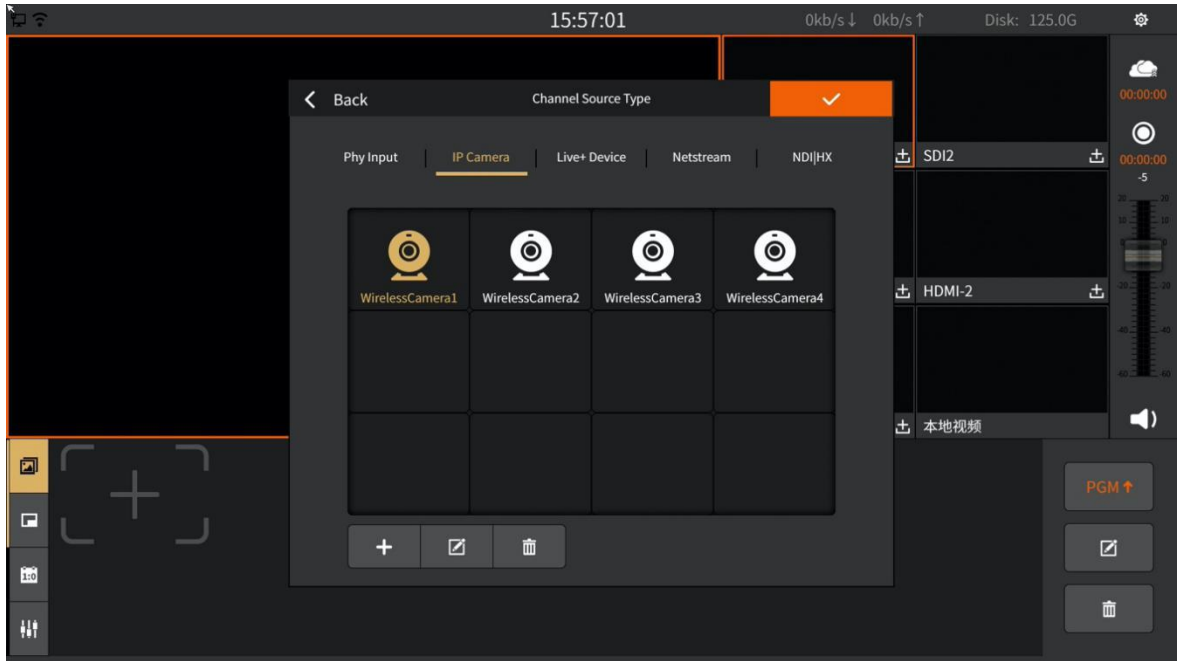

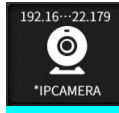

The onvif auto discovery function can automatically search IP cameras in the same network

segment, and the searched cameras can be directly added to the device list; the devices with * need to enter the account number and password to login before they can be added.

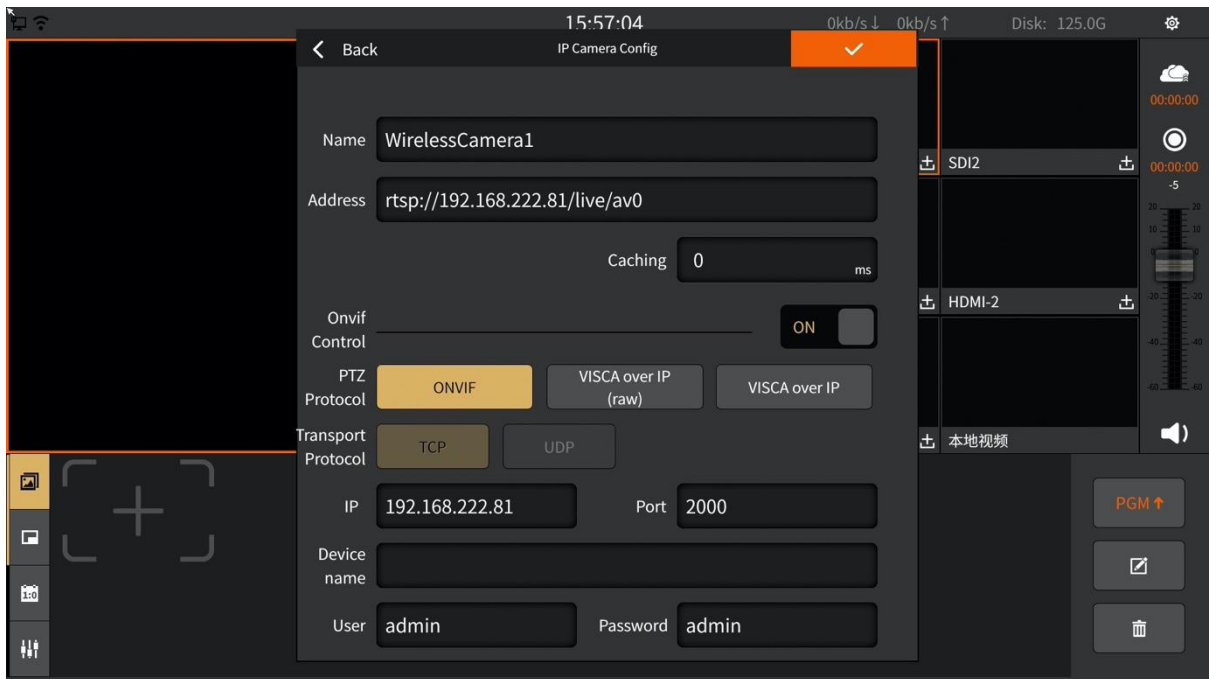

"Manual input and add" just need to input related parameters. Among them, PTZ control can be set, and PTZ control protocols are supported: ONVIF, VISCA over IP and NDI protocols. The interface is as shown below:



After loading successfully, click the PTZ control button  and the PTZ control interface will pop up. Supports control including rotation direction, zoom, pan/tilt speed, preset position setting control, the interface is as shown in the figure below:



3. Live+ Device

You can use the VJMobileCast application to access the mobile screen, and both internal and external networks can be accessed.

The signal can be directly scanned by the APP or enter the ID number. The accessed signal is displayed in the "Device List", and the screen that needs to be loaded is selected by clicking. **(Note: the original code is not available after resetting the code, you need to rescan the new code)**

The setup interface is shown below:

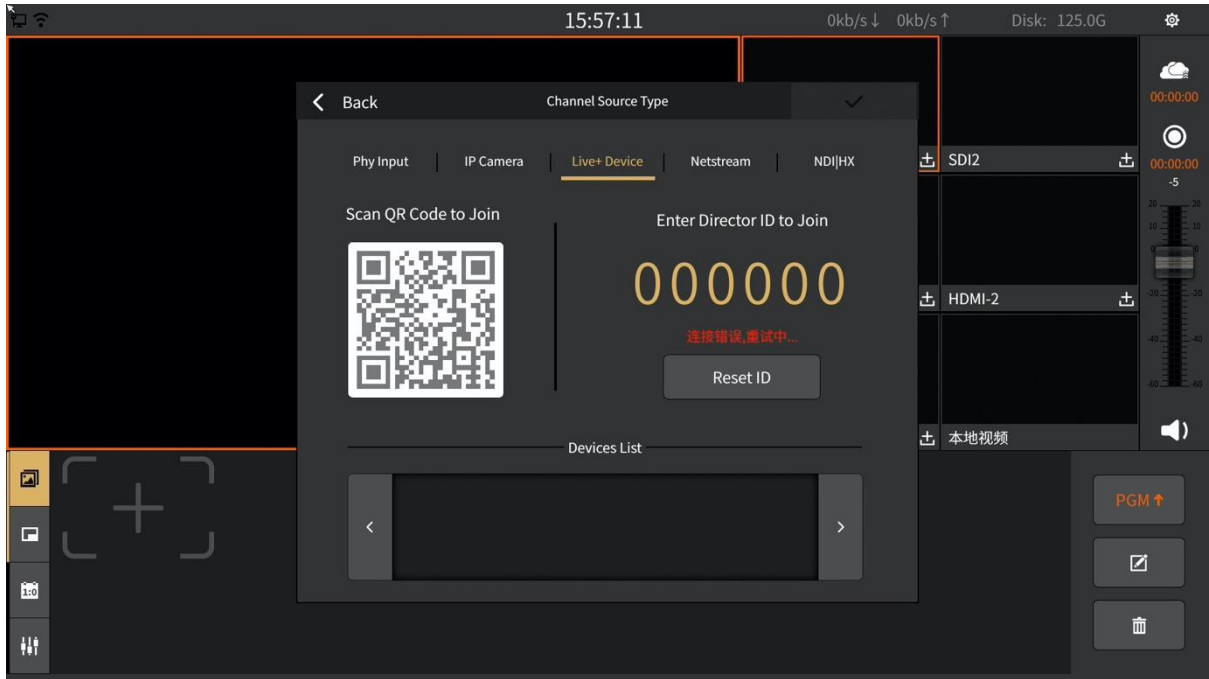

4. Netstream

It support rtmp/rtsp format, as shown in the following figure:

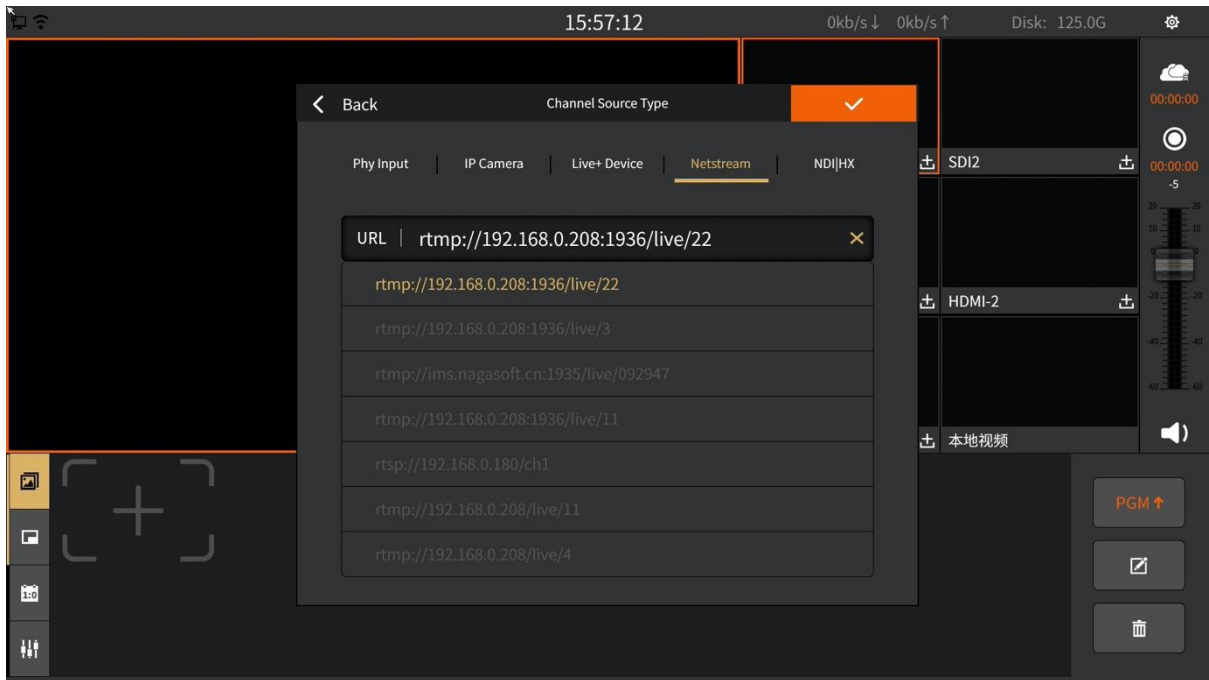

In order to make the network stream easier to fill in, you can use the on-screen input function, the function is as follows:

- 1) Click the input box and click the on-screen input icon  in the pop-up input interface.
- 2) For example, use the WeChat scanning function on the mobile phone to scan the QR code, as shown below:

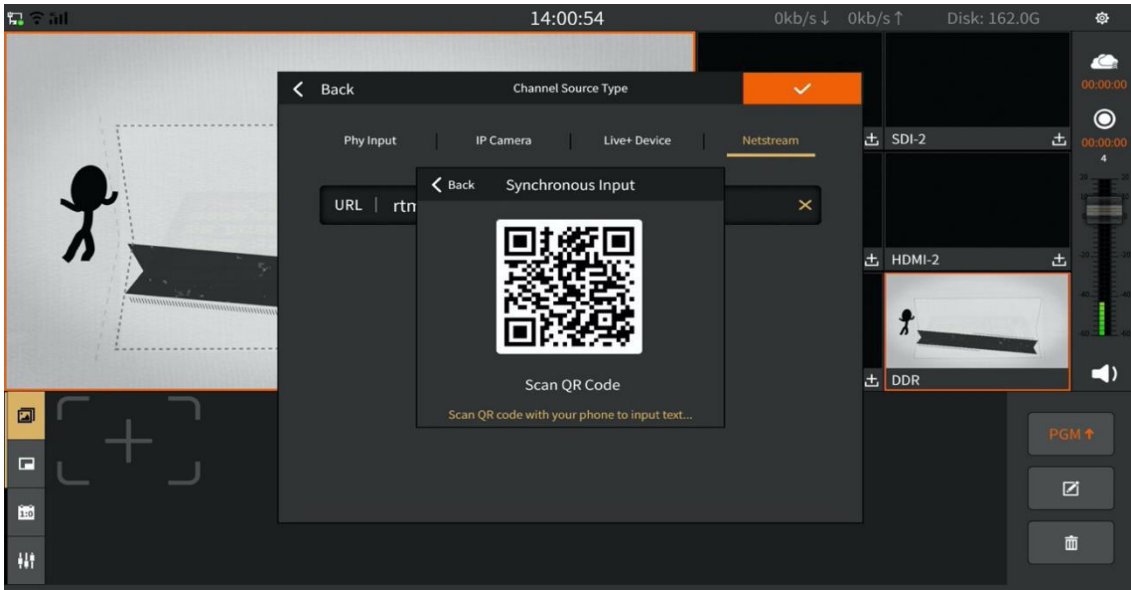

3) The input interface can be popped up in the mobile phone, as shown below:

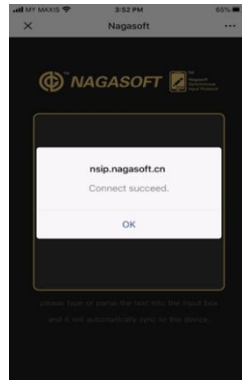

4) Paste the network stream directly into the input box, and the attached content is also synchronized to NSCaster X1 URL input box, as shown below:

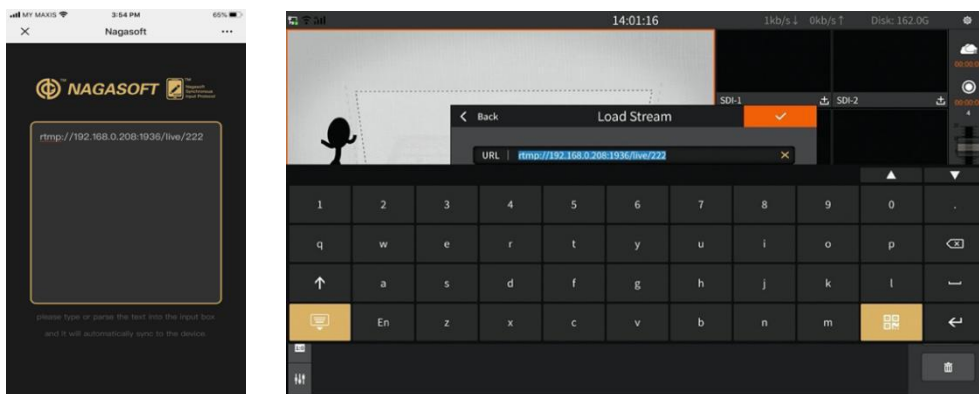

5. NDI | HX

You can load the NDI devices in the LAN, and click the refresh button to automatically discover them, Loading NDI streams for native output is not supported, as shown in the figure below:

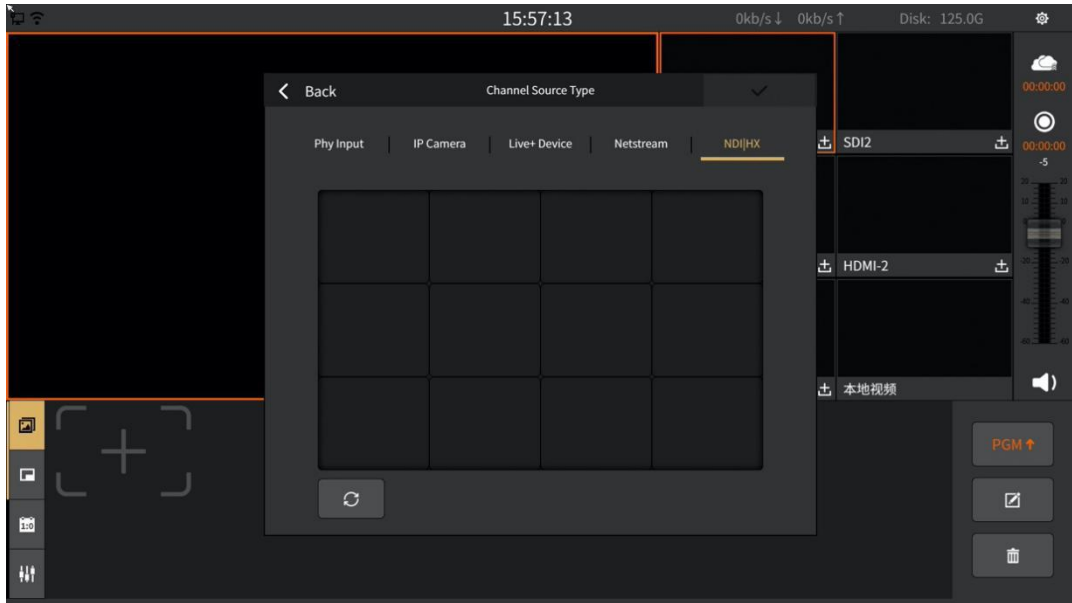

6. The channel name can be changed, as shown in the figure below:

Double click the channel name to enter the channel name editing status, as shown in the following figure:



3.1.3 NET Channel

The NET channel is used to load network streams and the supported formats are: rtmp/rtsp. You can also directly load IP cameras, Live+ devices, NDI|HX.

- 1) Select the added IP camera in the list, click the "✓" icon to confirm the selection, the setting interface is as shown in the figure below:

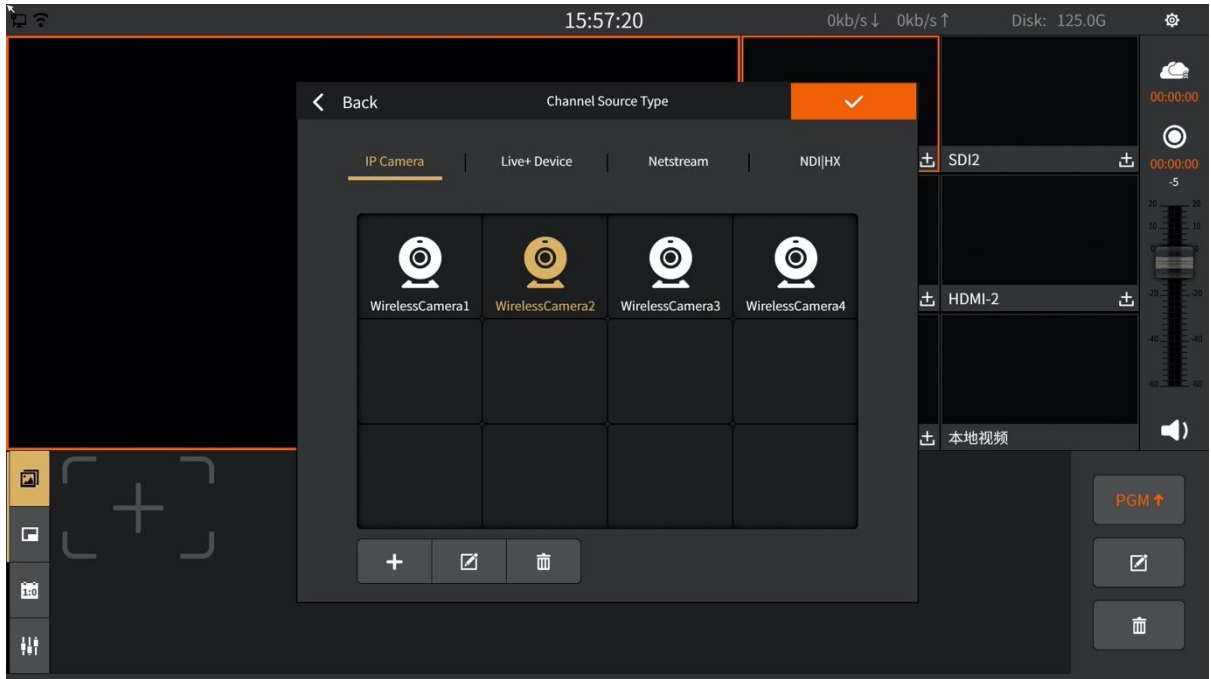

- 2) You can use the VJMobileCast app to access the mobile screen, both internal and external networks can be accessed.

The access signal can be accessed through the APP directly by scanning the QR code or entering the ID number. The access signal is displayed in the "Device List", click to select the signal screen that needs to be loaded to the mobile terminal. **(Note: The original ID is unavailable after resetting the ID, you need to rescan the new ID)**

The setting interface is shown below:

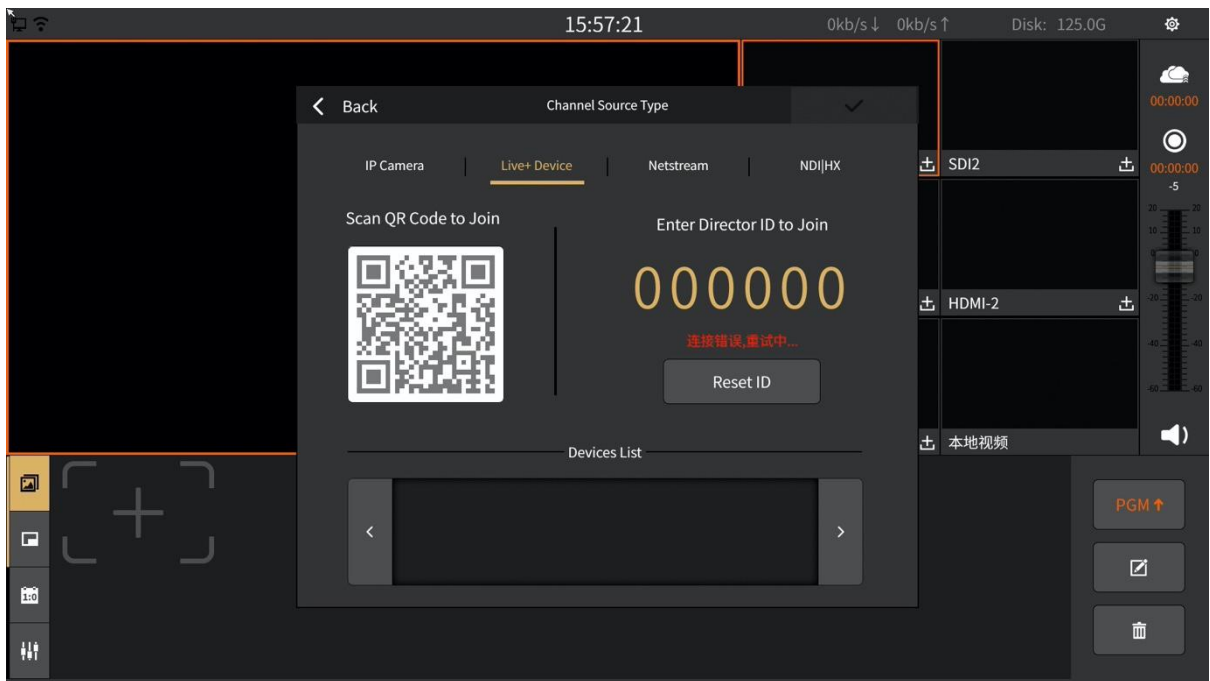

- 3) Click  to enter the network stream editing interface, fill in the complete network stream

address in the URL, and use the same screen input function to quickly enter the stream address. As shown below:

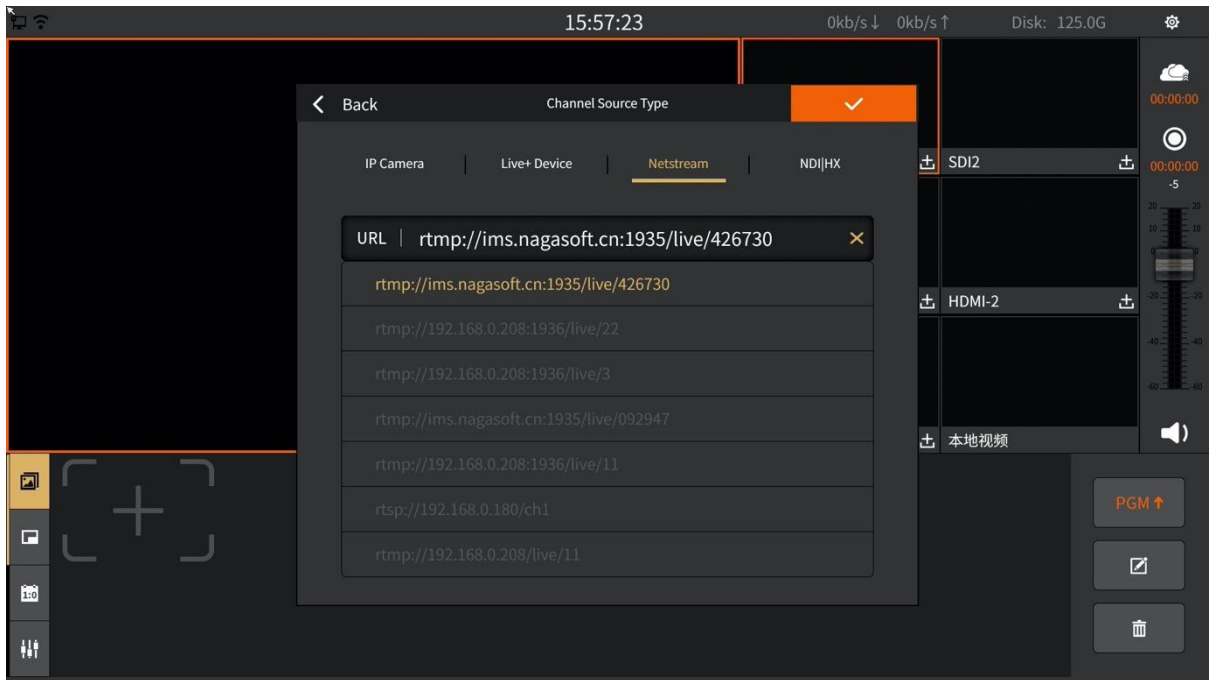

- 4) The NDI device in the LAN can be loaded, and it can be discovered automatically by clicking the refresh button, as shown in the following figure:

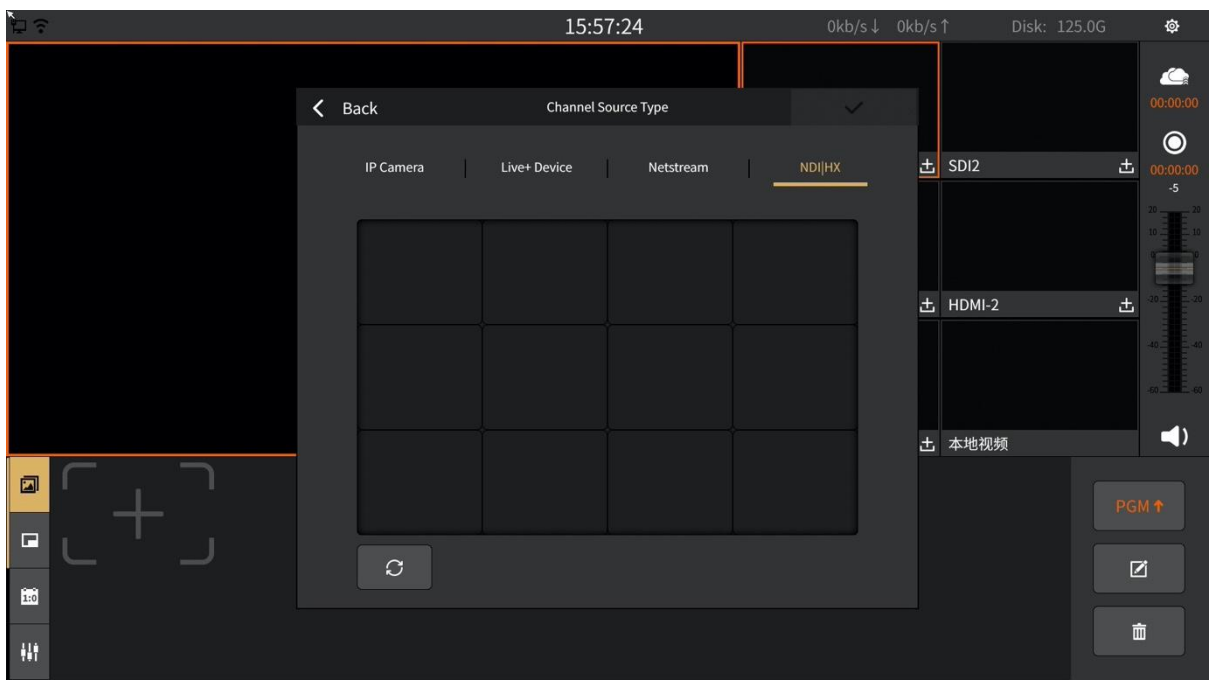





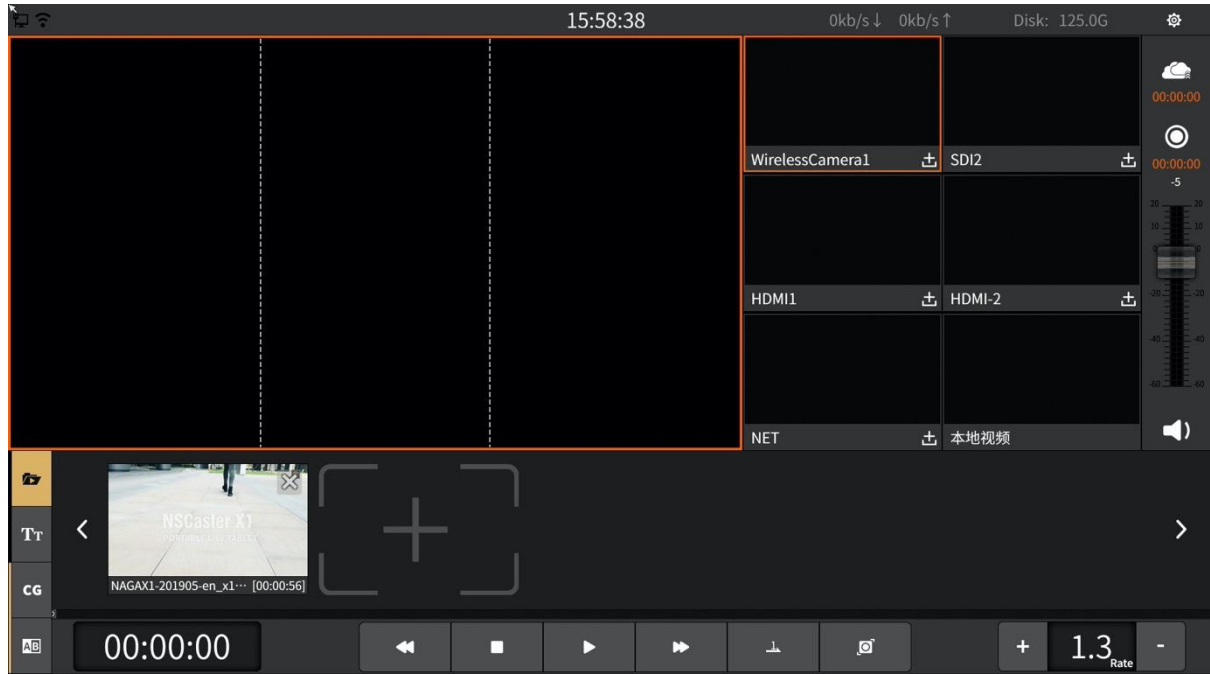



3.1.4 DDR Channel

The DDR channel is used to load video footage as shown below:



1) The button for loading video material is as follows:

- Button  : Add video
- Button  : Play/pause video
- Button  : Stop
- Button  : Back 10 seconds
- Button  : Fast forward 10 seconds
- Button    : Separately, play in list order, play single video loop and play in list loop
- Button  : The progress adjustment button is enlarged to adjust the video progress
- Rate button: You can control the rate of playback.



3.1.5 Image Overlay

Image overlay panel can publish image to the PGM monitor. It support png image format and location movement of images as shown below:



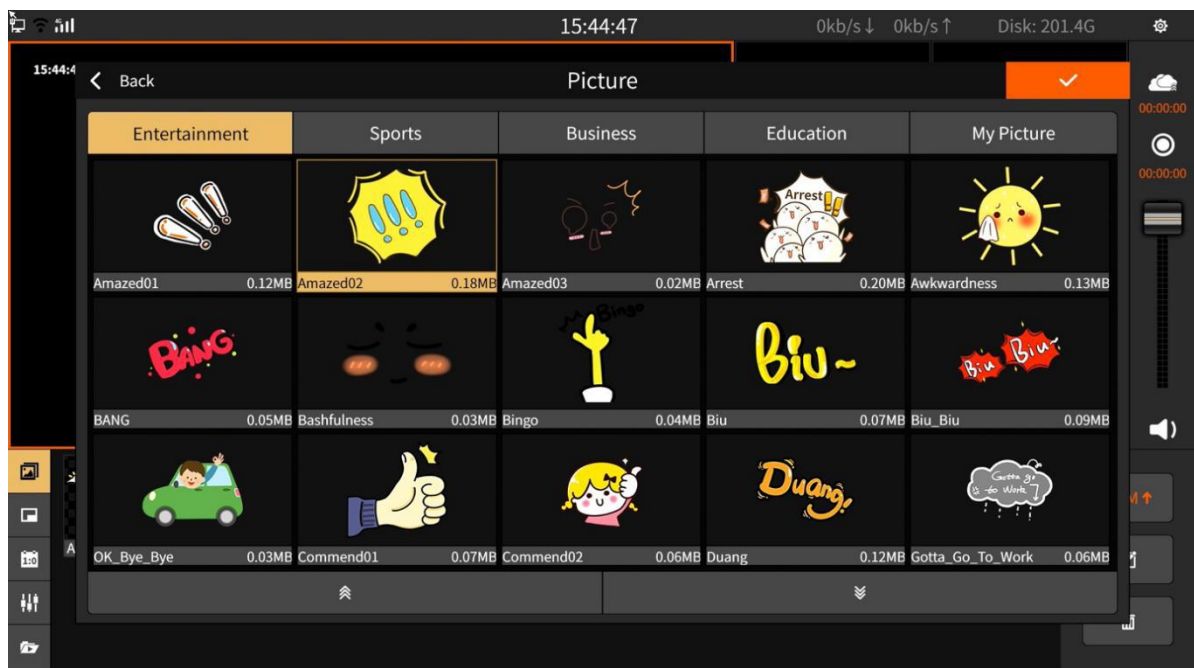



- 1) Click the button “ + ” to enter the photo editing interface, and then click the button “ + ” to add a picture. There are two ways to source images:
 - Online download. Click "Download" to download.
 - Customize “My Picture”. You can copy the picture to the “My Pictures” folder which located at the “File Transfer” interface as shown below:

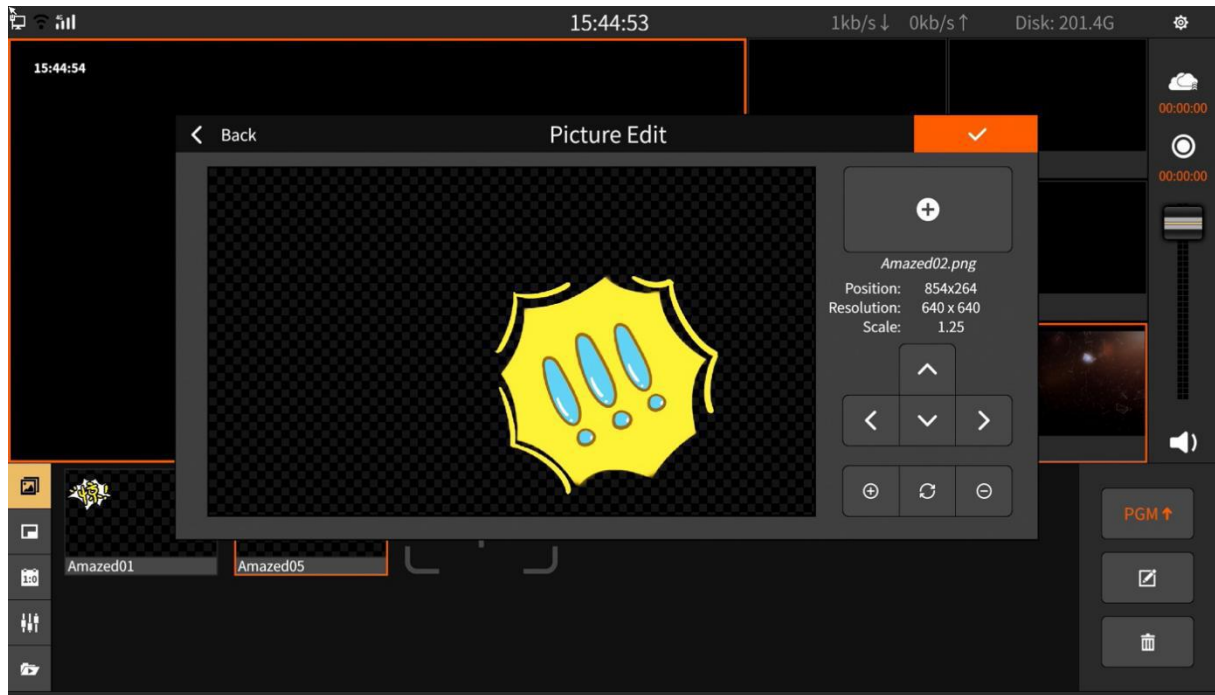

- 2) Click  to send it to the PGM, and click again to not display.
- 3) Click  to enter the photo editing interface. In the picture editing, you can drag and drop the picture manually to adjust the position and size of the picture, as shown below:



Button operation is as follows:

- Four button  : Adjust the position of the picture in the up, down, left, and right directions
 - Button  : Zoom in
 - Button  : Zoom out
 - Button  : Restore image to initial state
- 4) Select the image and click  to delete the image.

3.1.6 PIP (Picture in Picture)

Picture-in-picture can display multiple channels on the PGM channel. Click **PGM ↑** to display the selected picture-in-picture mode in the PGM channel, where A/B/C/D represent the screen of the channel. For example, select A in SDI-1 channel and the A area of the PGM will display the screen of SDI-1 channel. The channel screen of A/B/C/D area on the PGM channel supports real-time switching. The picture-in-picture template is divided into the following two types:

- 1) No background image template as shown below:

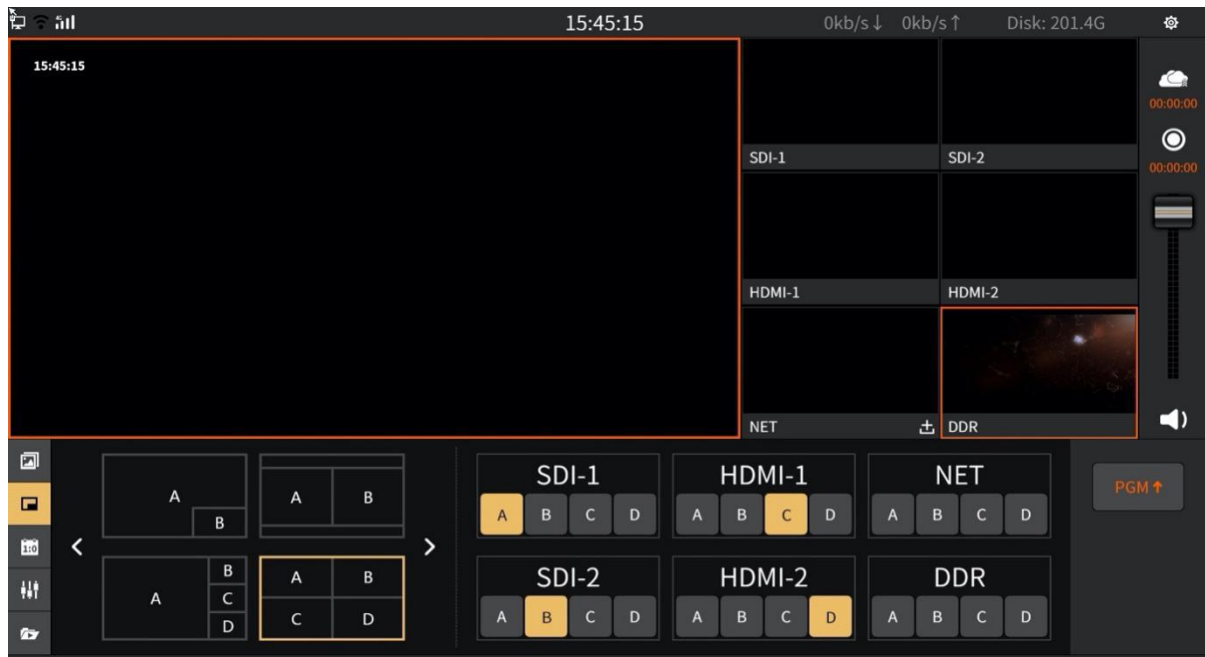

- 2) Add background image template. The background image is stored in the "picture material" folder of the "file copy" interface. Click the "configuration" button to edit the picture in picture, including changing the background image, stretching and clipping the picture, changing the size and position, and cutting the channel picture freely. As shown below:

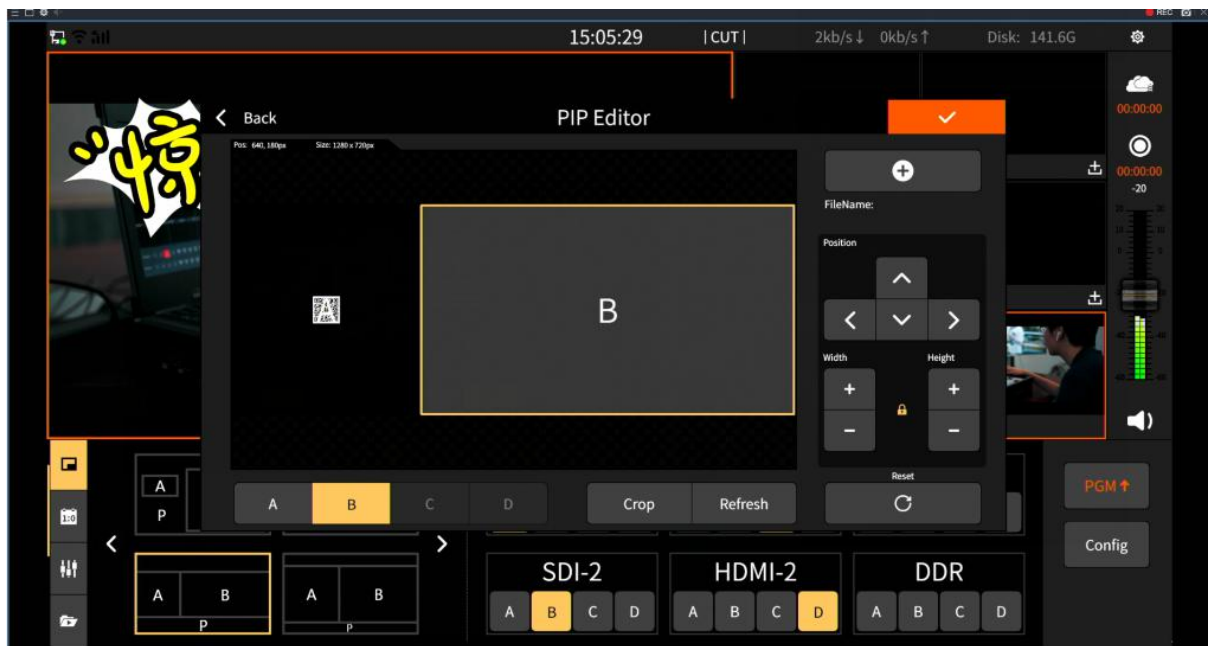

3.1.7 Scoreboard

The scoreboard can record the score of the live match in real time as shown in the figure below:



1) Button operation is as follows:

- Button **PGM ↑**: Display the score board to the PGM channel and click again to cancel the display.
- Button **Template**: Choose the template of the scoreboard. The templates are general, basketball, football, table tennis, badminton and volleyball. It also support online download. In order to download, just click the “Download” button as shown below:

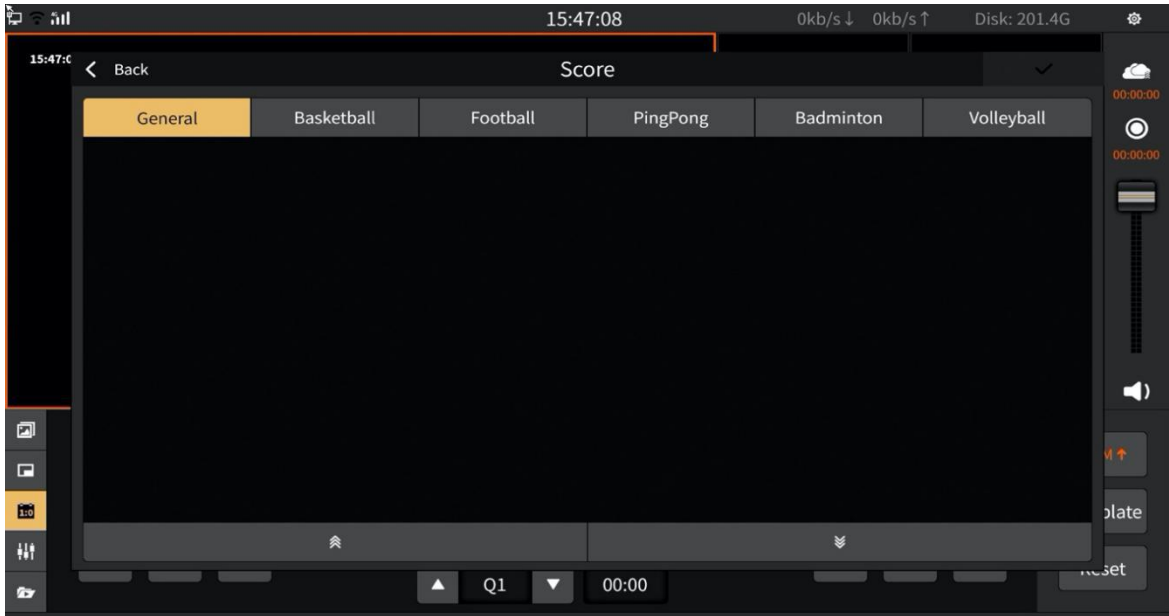

- Button : “+/-” can “increase/decrease” scores in real time.
- Button : Start/pause timing. The status will become yellow highlight when it start. “+/-” can “increase/decrease 1 second” in real time.
- Button : Clear the score and timing.

3.1.8 Audio Mixer

The mixer is used to control the gain and mix of all input and output audio as shown below:

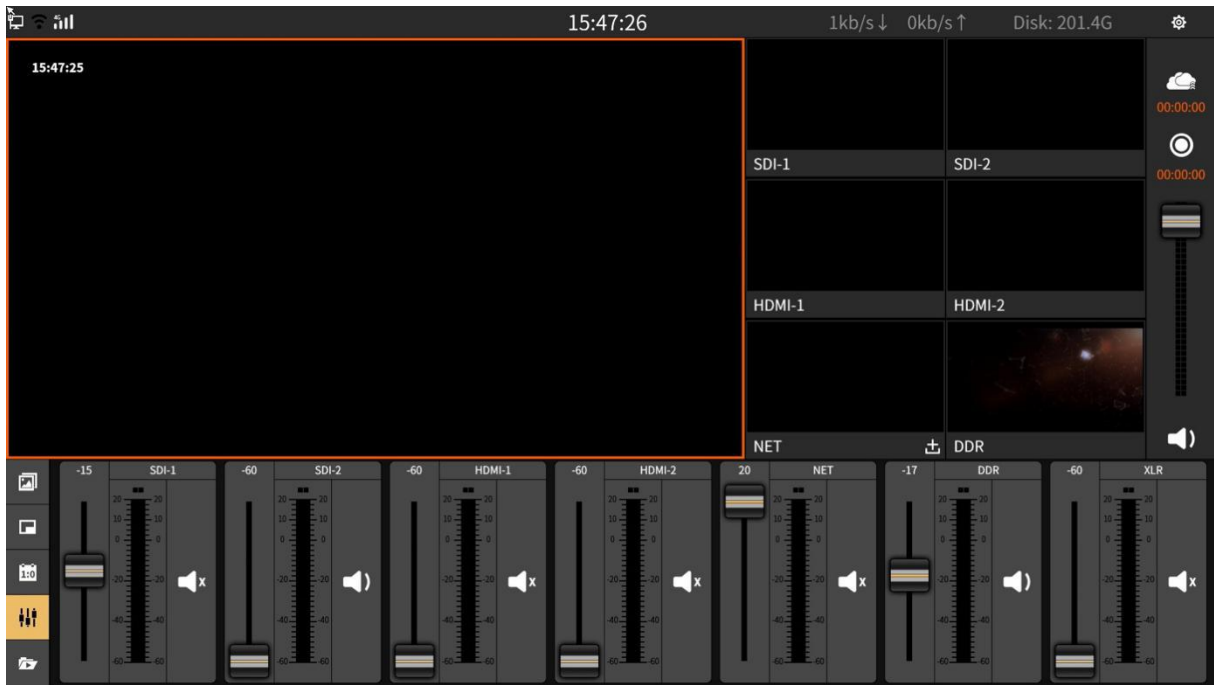

- 1) Button operation is as follow:
 - Button : Mixing output.
 - Button : Mute.
 - Button : Volume adjustment fader.

3.1.9 Subtitle

You can upload simple subtitles to the PGM by manually inputting subtitles or import txt file. The subtitle panel interface is as shown below:

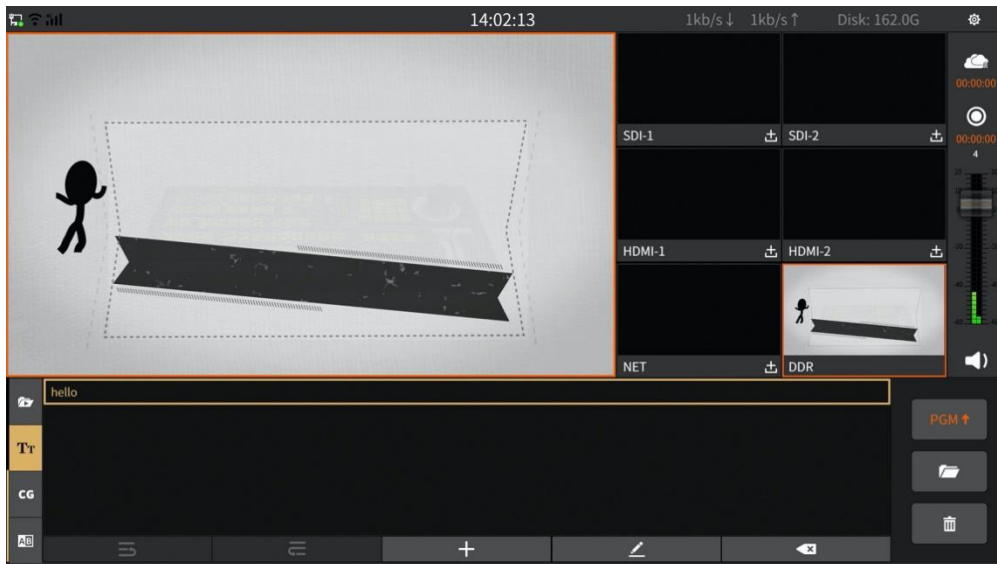

1. Add subtitle

1) Fill in input

Click the “+” icon to manually enter the subtitles. In the input content, you can adjust the font type, size and use three parameter values as required. The figure is shown below:

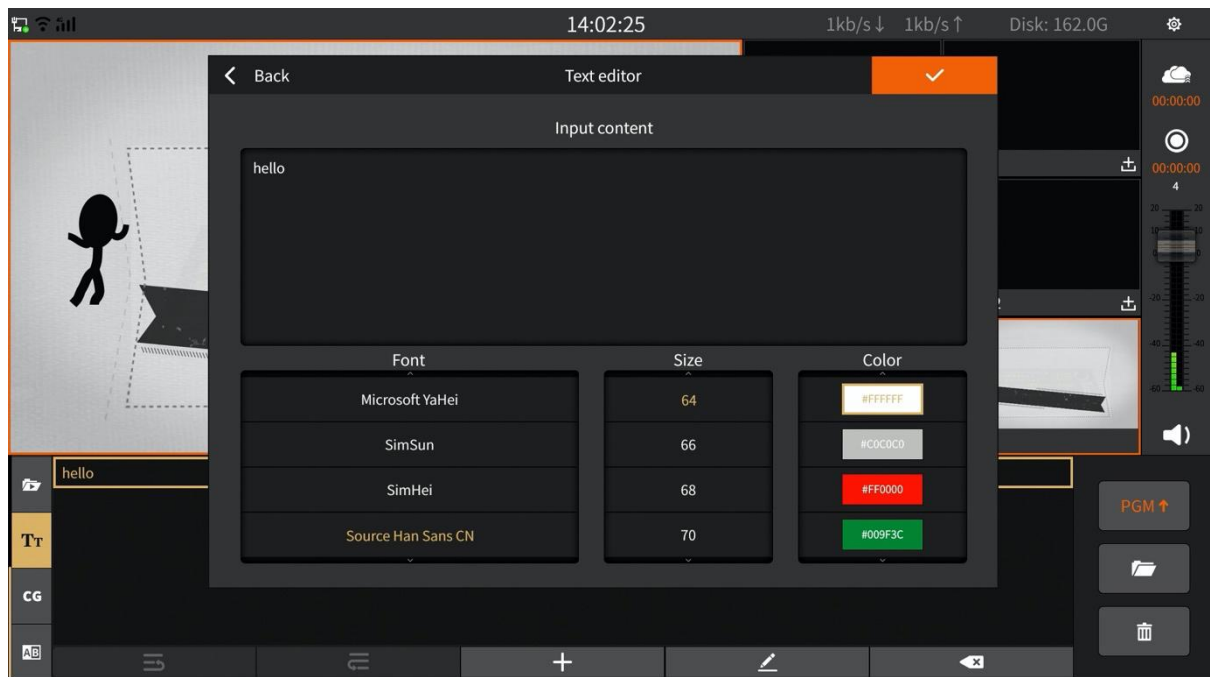

2) Import txt file

Click the  icon to copy the TXT format file to the folder marked as “Subtitle” by USB, as shown below:





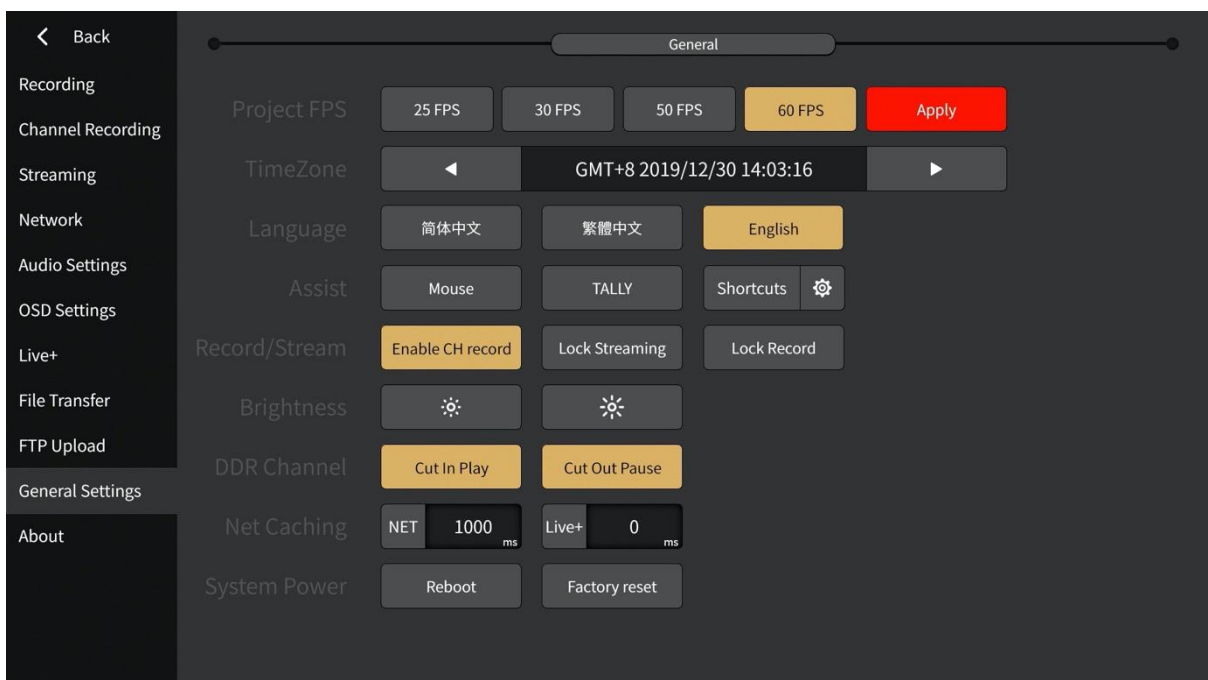

2. Master monitoring on subtitles

- 1) Press the button  manually to upload the subtitle to the PGM monitor.
- 2) Using keyboard shortcut key to upload subtitle.

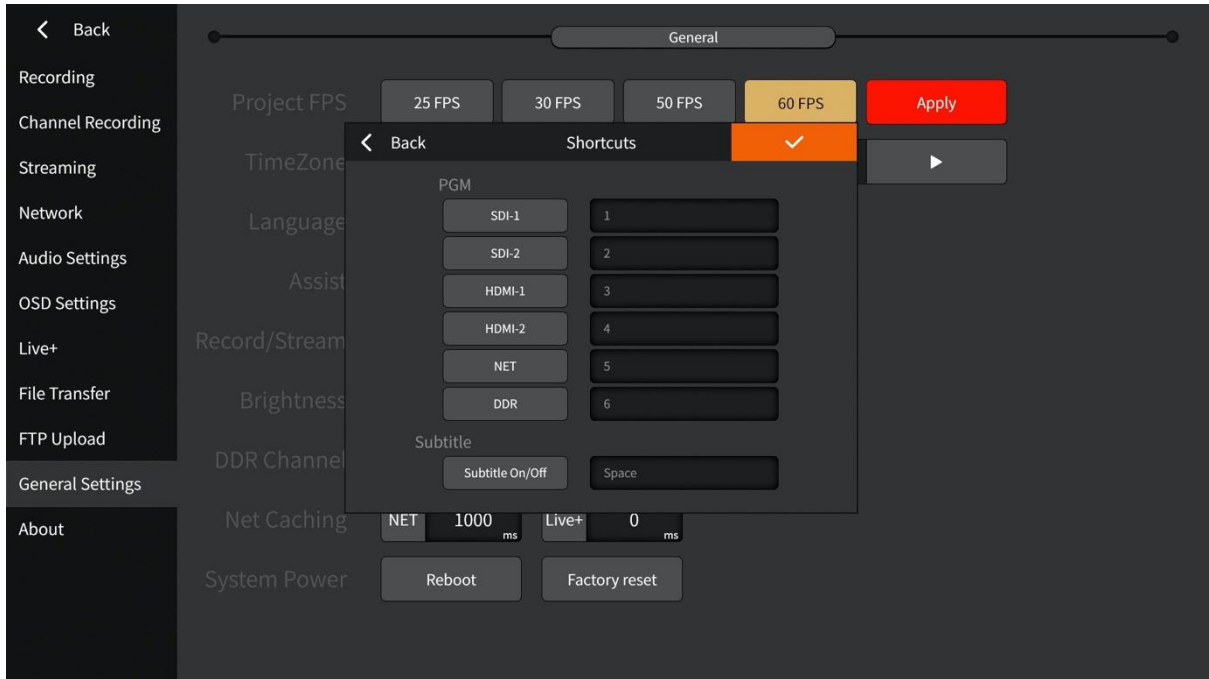
By accessing the USB keyboard, you can click on the key to upload the subtitles. Set the shortcut key for subtitles to be selected. In “General Settings – Assist – Shortcuts”. By default, Space key is used to upload the subtitles, as shown in the figure below:







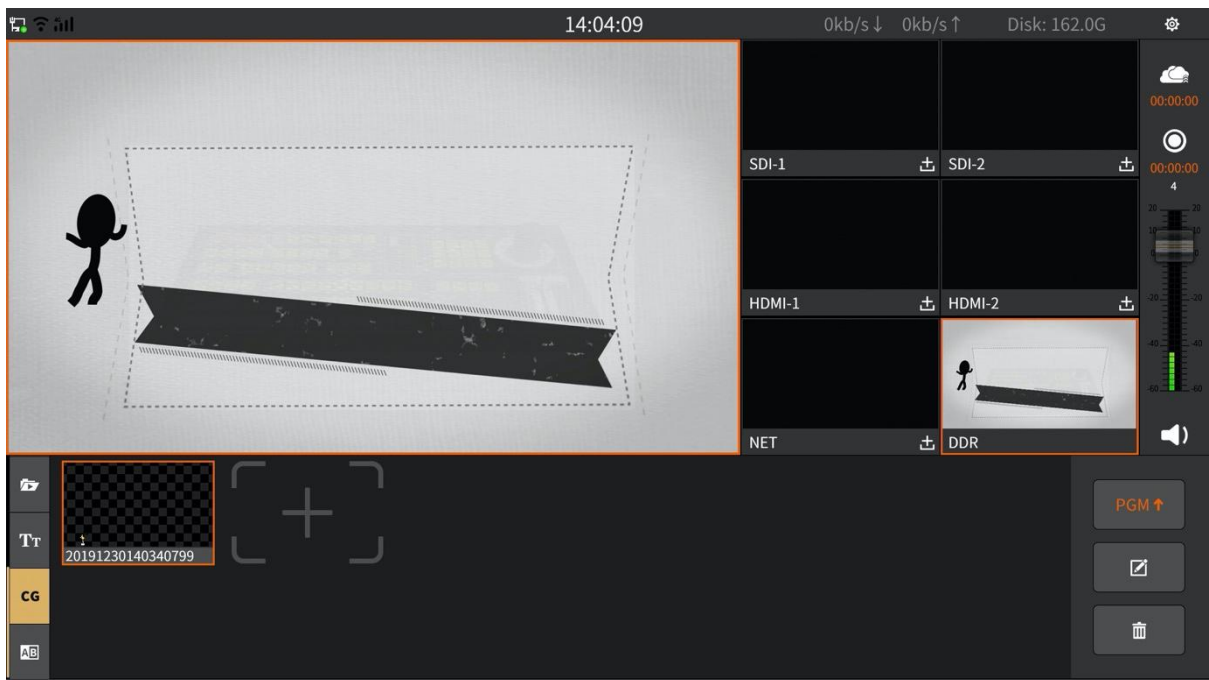

3. Click  to delete the selected subtitles and click  to clear the subtitles.
4. Select  to edit subtitles.

3.1.10 CG

CG is a template composed of pictures, texts, etc. It can be used during live broadcast or recording. The interface is as shown below:



- Click  to create CG.

- Click  to upload the selected CG to PGM.
- Click  to edit the selected CG.
- Click  to delete CG.

1. Create CG/Upload CG

In the CG editing interface, you can choose to add CG template/picture/subtitle, you can manually adjust the parameters of each element including size, position, etc. The editing interface is shown below:

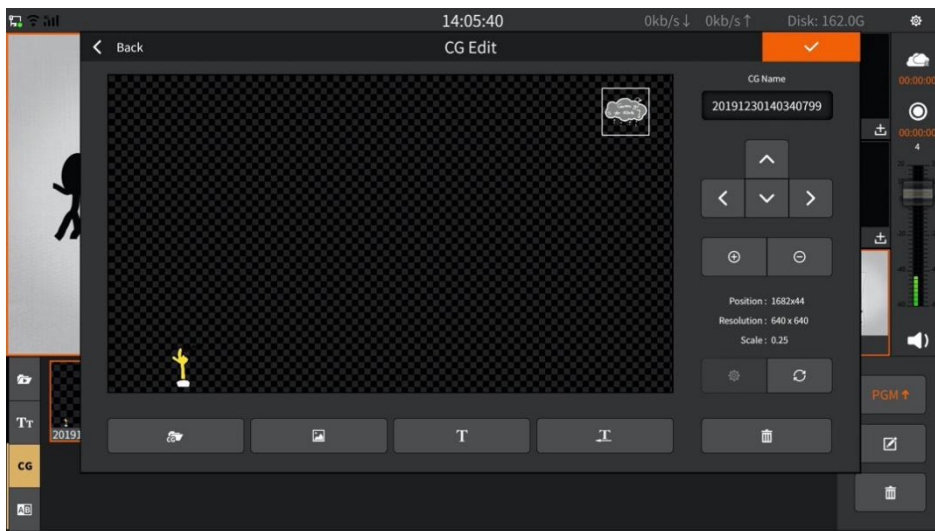

1) CG template / import CG

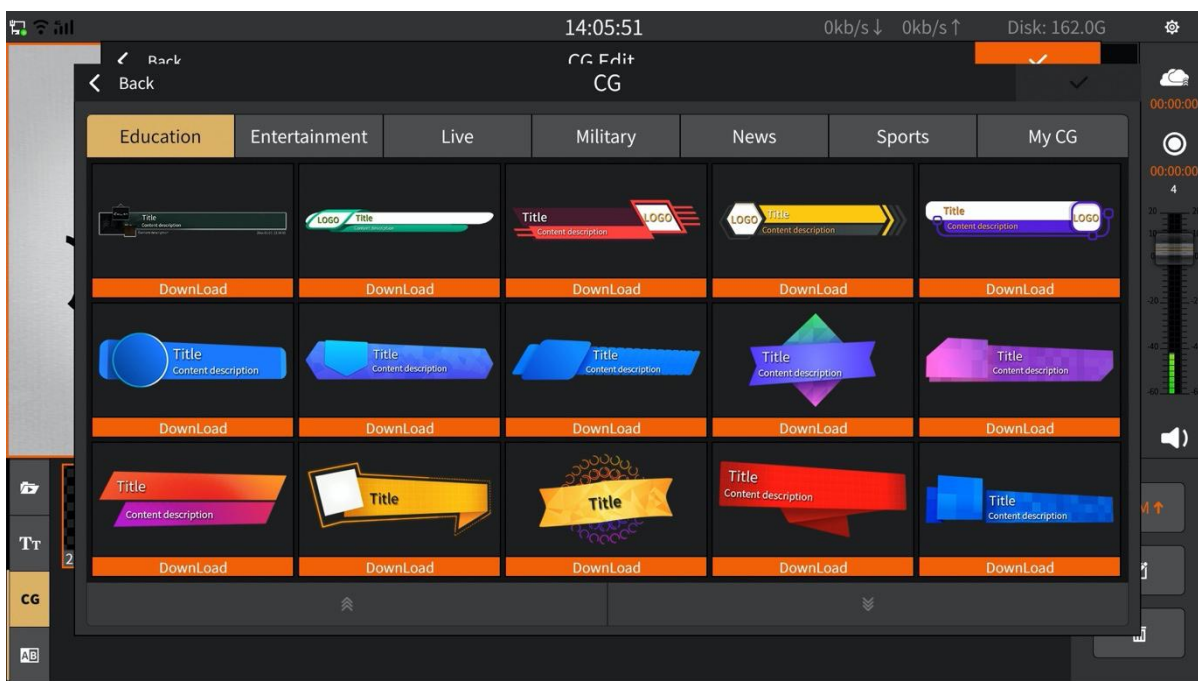

2) Import image

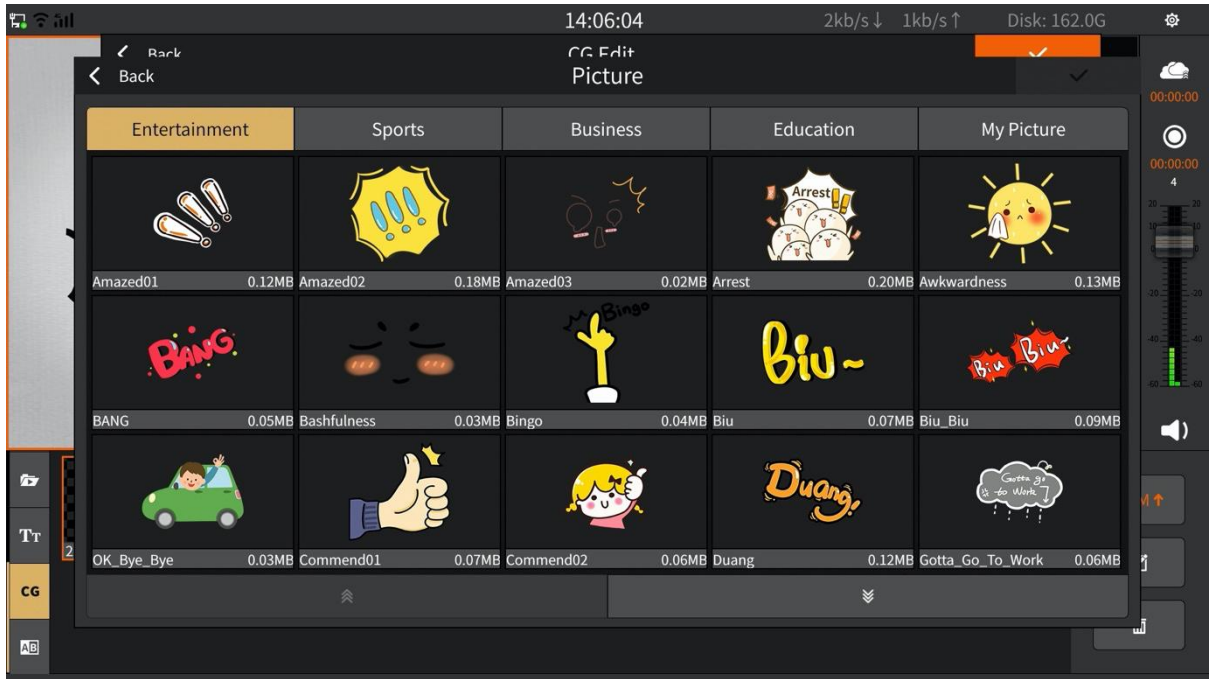

3) Subtitle/left scrolling subtitle

You can add subtitles in the CG page, or move the subtitles from the lower right corner to the left. After adding the content, you can set the font style, size, and colour of the content, as shown in the following figure:

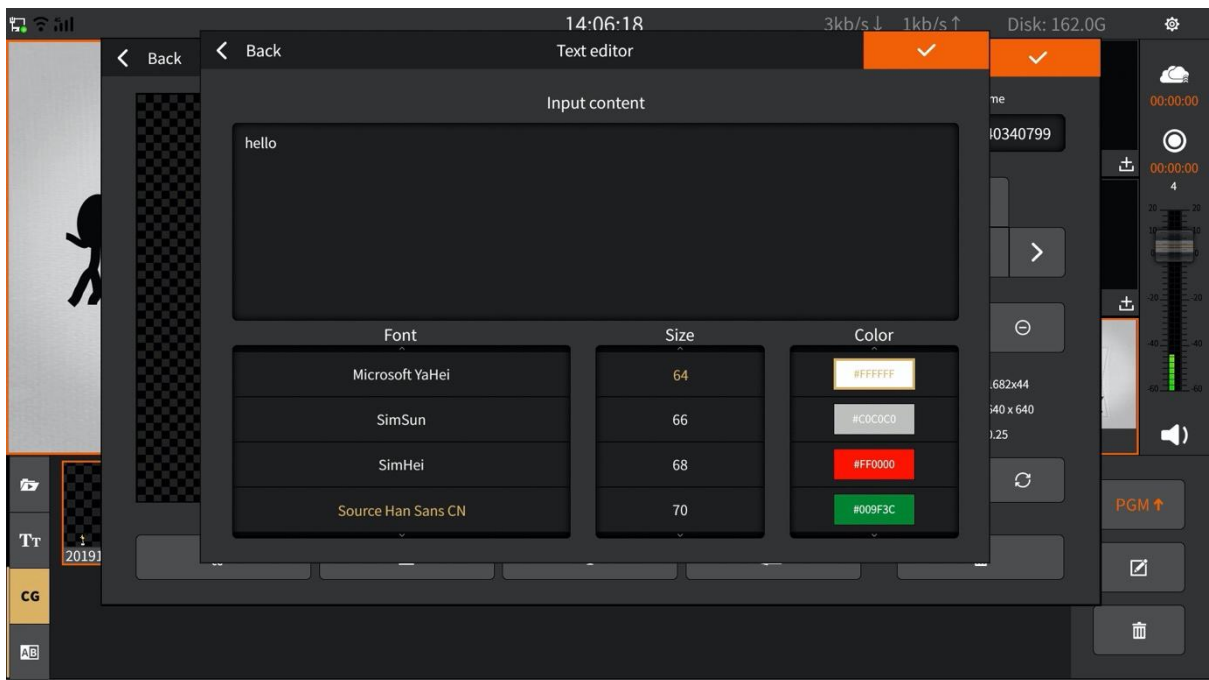

After you have created the CG, click  to display the edited CG on the PGM monitor screen.

2. Remote CG

Enable remote CG access in the OSD Settings. You need to use the CG editor (NSCGEditor) to implement online CG. For details, please see the appendix: "CG Editor Operation".

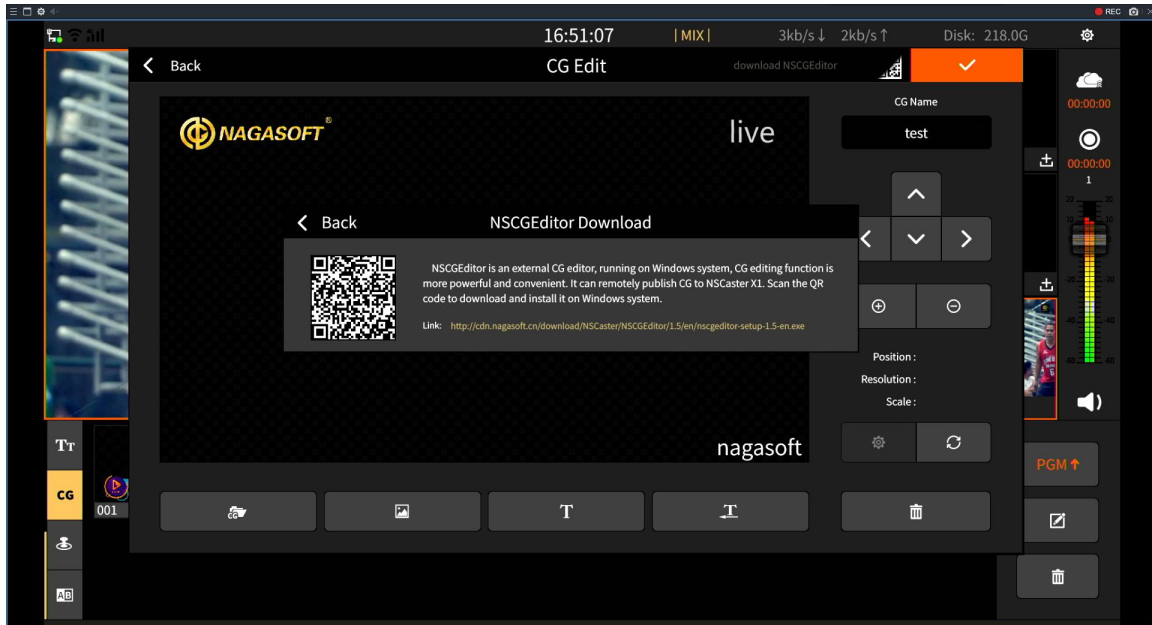



3.1.11 PTZ control

Support camera rotation direction control, zoom, pan tilt speed, preset position setting control. You can click  to add PTZ parameters directly. Visca protocol supports focusing and aperture operation. The setting interface is as follows:



3.1.12 Special Effects

Select the effect for channel switching, and set the duration of the effect switching process - the transition time, and then click the channel that needs to be monitored on the PGM monitor to achieve the transition effect of the two channel screens. There will be  or  in the title bar to distinguish cut from transition effect. The setting interface is shown below:



3.2 NSCaster-X1 Settings Interface

Click  to enter the setting interface. Respectively, there are "Channel Recording, Recording, Streaming, NDI|HX output (if the module enabled), Network, Audio settings, OSD settings, Live+, File Transfer, General Settings, About" module as shown below:

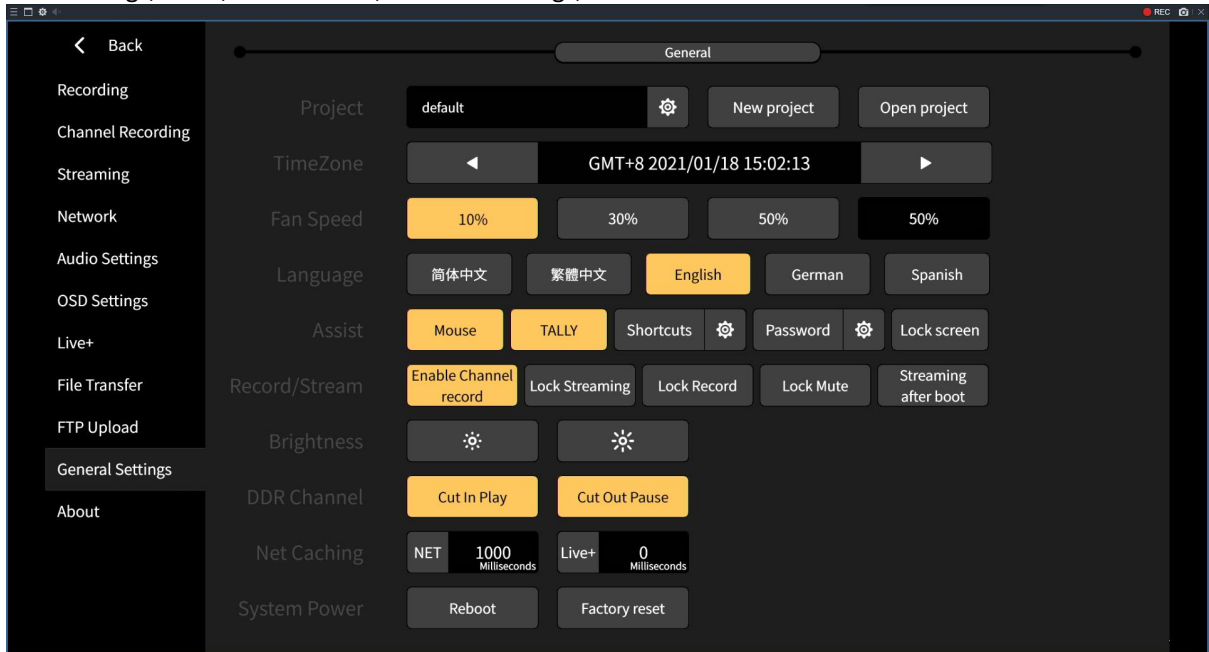

3.2.1 Channel Recording

Note: This function is required to be enabled after "General Settings – Record/Stream - Enable Channel Recording" is turned on.

It can record channel audio and video and also support recording of SDI-1, SDI-2, HDMI-1, HDMI-2 and NET channels. The recorded files are stored in the "Record/channel" folder which located at the "File Transfer" interface.

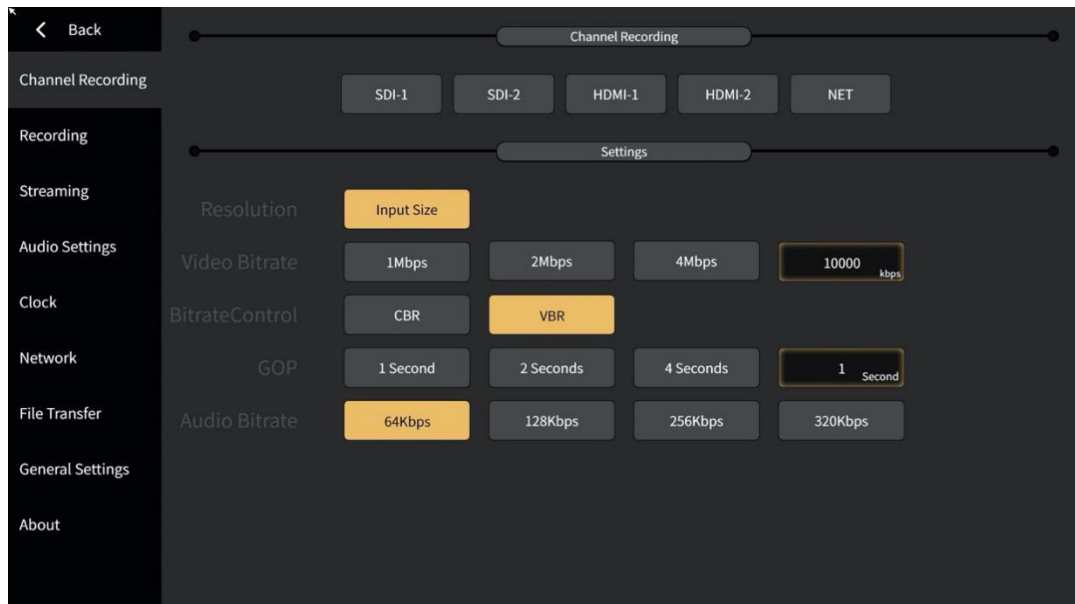

The bitrate and GOP in the interface can be customized. Click the custom box to pop up the editing interface, where the bitrate custom interface as shown below:

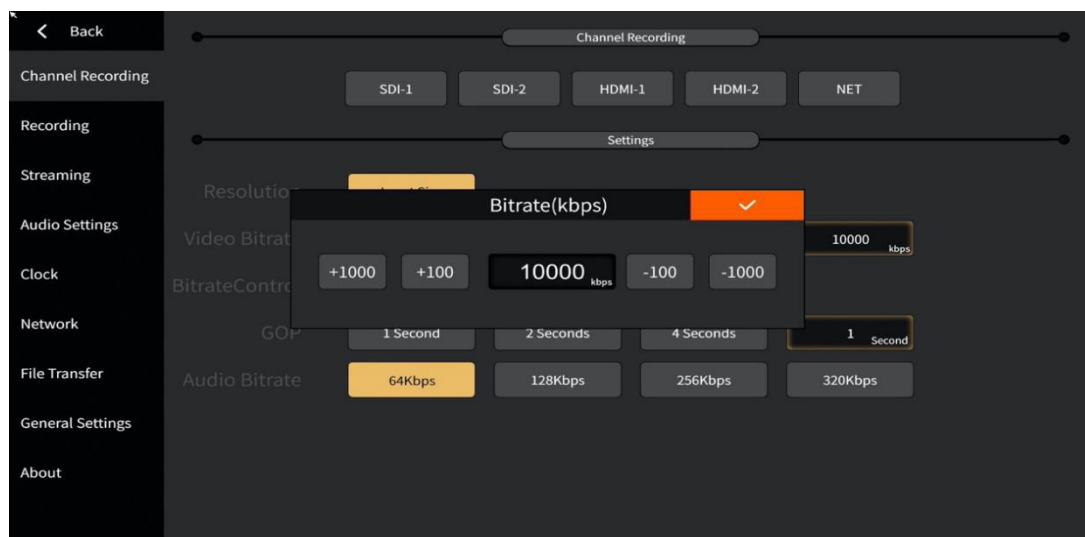

Note: If the recording is interrupted in the middle, the file will be damaged and you need to use the repair tool to repair the recorded file.

3.2.2 Recording

Record the contents of PGM. Click the button  on the “Main Interface” to start recording, and click again to stop. The recorded files are stored in the “Record/pgm” folder which located at the “File Transfer” interface as shown below:

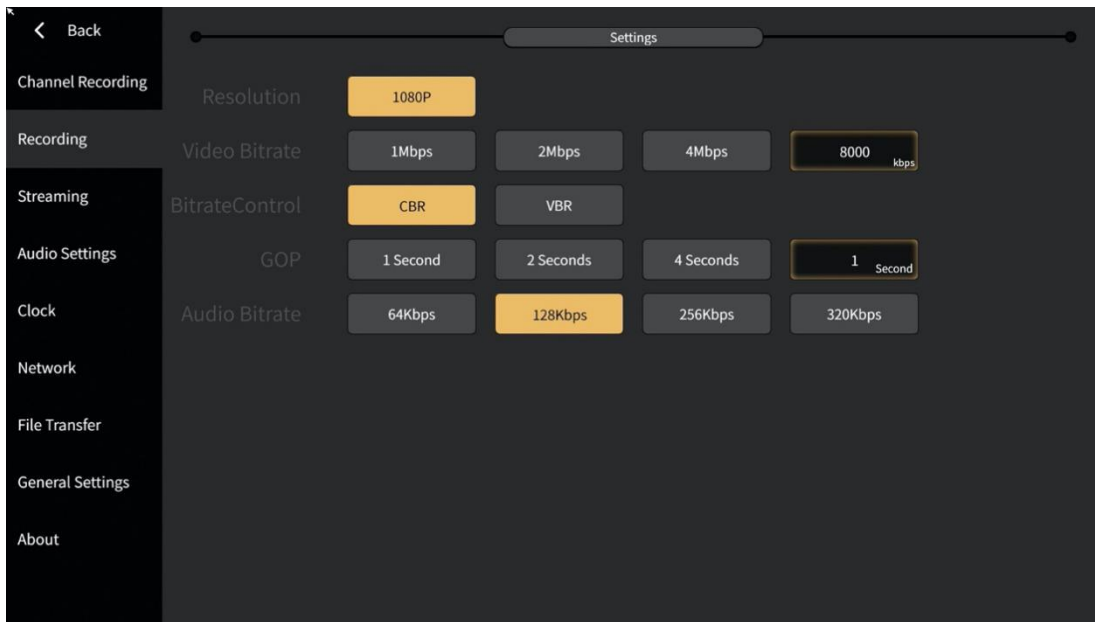

Note: If the recording is interrupted in the middle, the file will be damaged and you need to use the repair tool to repair the recorded file.

The bitrate and GOP in the interface can be customized. Click the custom box to pop up the editing interface, where the GOP is customized as shown below:

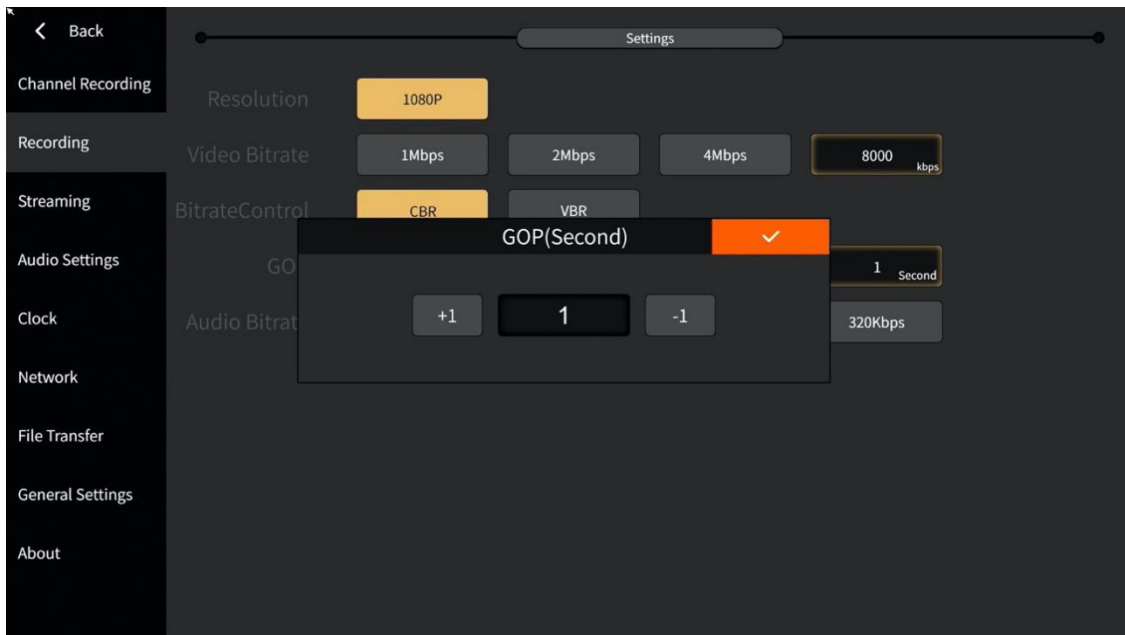

3.2.3 Streaming

PGM streaming is sent to VJLive3, FMS, WOWZA, etc. through RTMP protocol for live streaming. Click the button  on the “Main Interface” to start the streaming and click again to stop. Video bitrate and GOP can be customized as shown below:

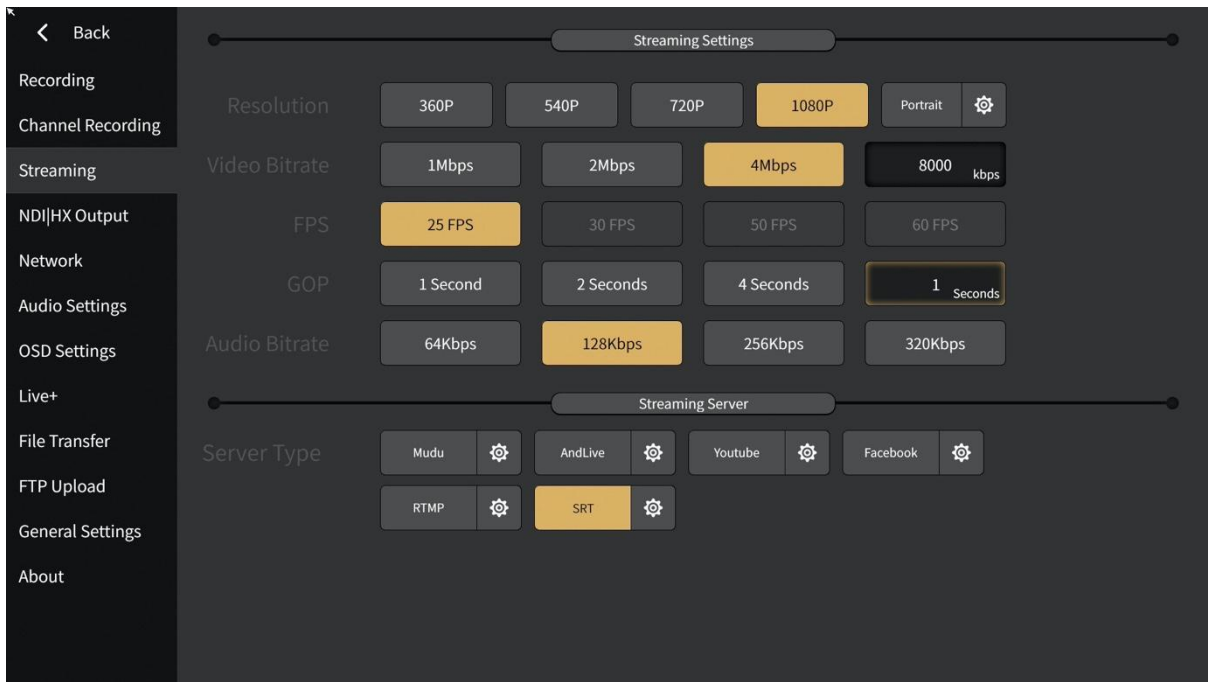

1. Vertical screen output

It can support 608x1080 vertical screen output. Select the vertical screen in the resolution and click the setting button to adjust the left and right margins in the setting interface to realize the vertical screen, as shown in the figure below:

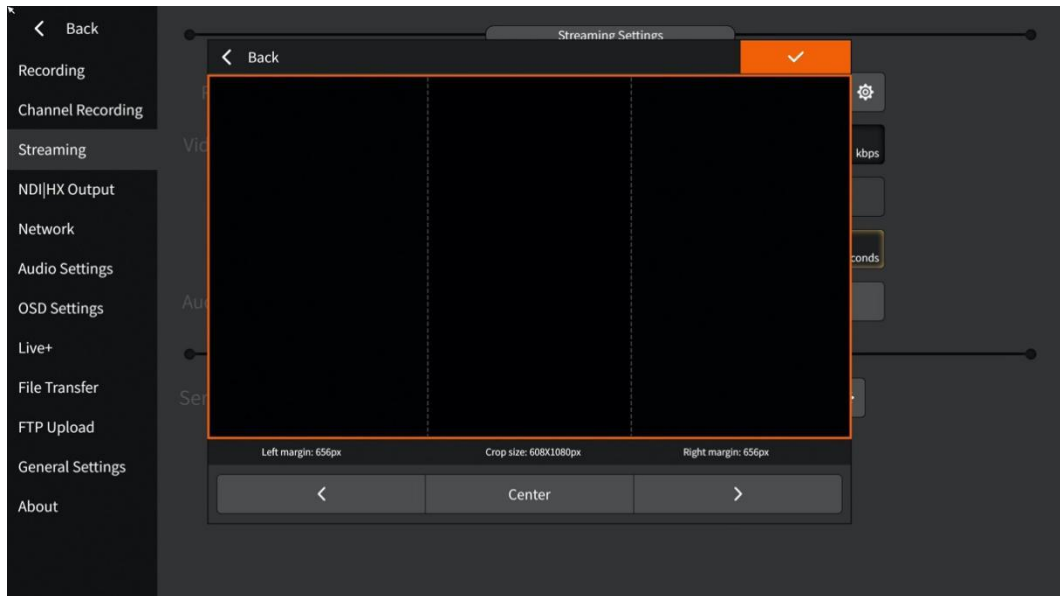

2. Live broadcast method

It supports Mudu and AndLive, and also supports RTMP protocol and SRT output.

- 1) Select the server type as "RTMP" and if channel push protection is set, then it require user to enter the username and password. If not, just ignore it. The format of "rtmp://" is: ip:port/live and "stream name" is the name of the channel as shown below:

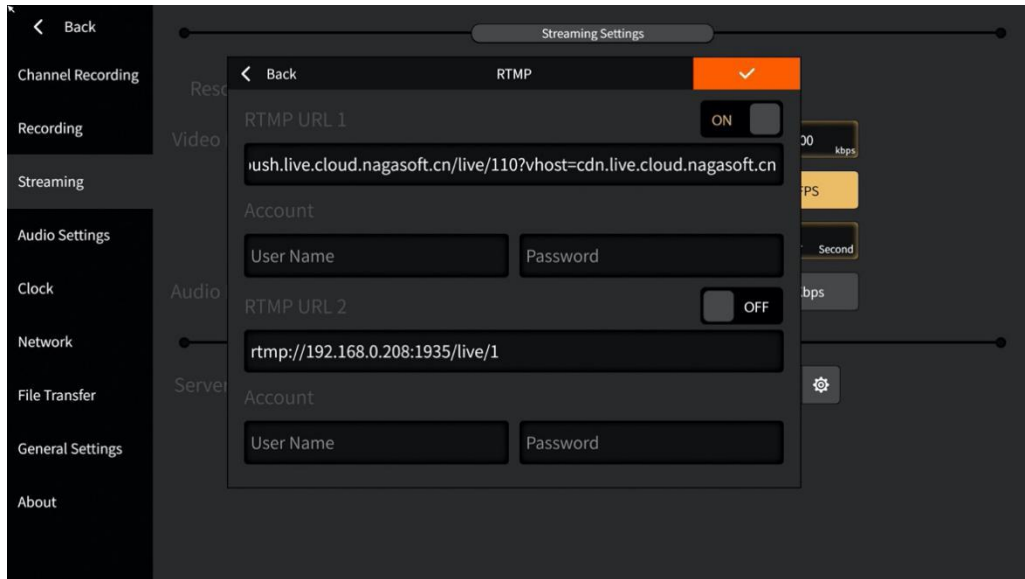

- 2) Select the server type as "Mudu". First, you must first register on the Mudu live platform, then fill in the username and click on the authorization to get the channel and encoding information as shown below:

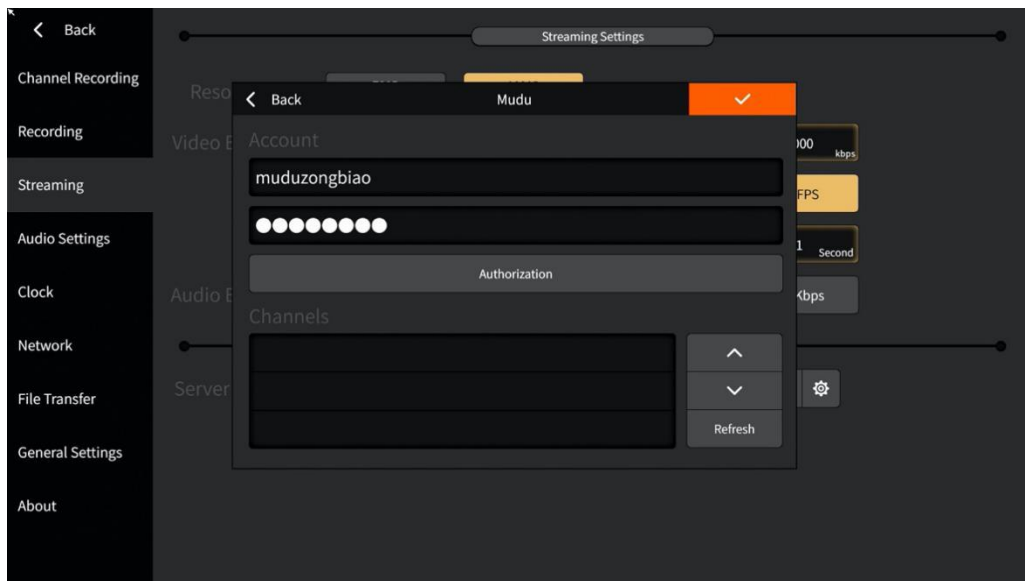

- 3) Select the server type as "AndLive". First, you need to enter the username and password, then log in to get the activity list as shown below:

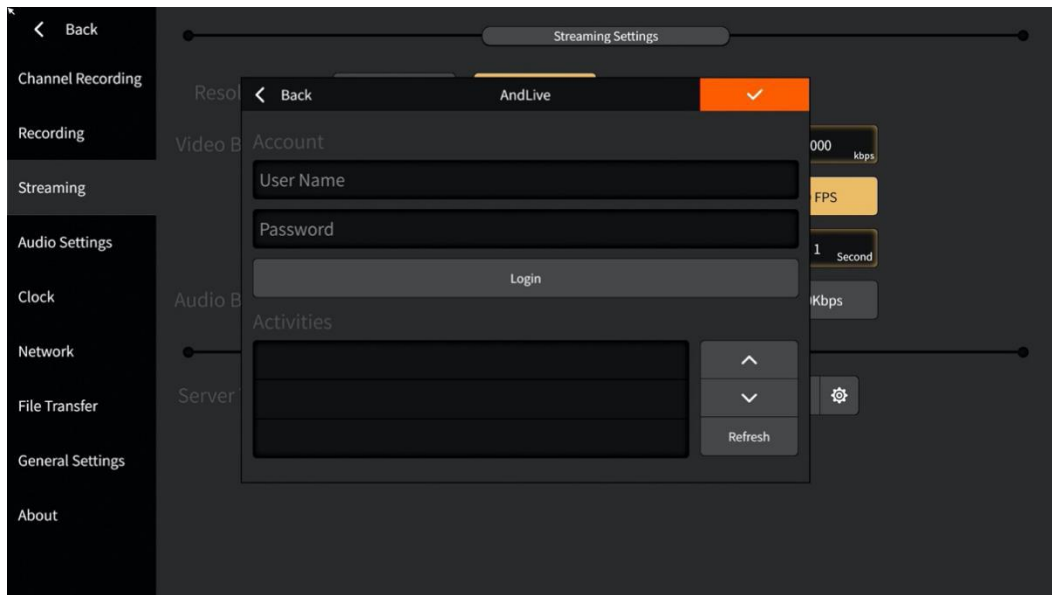

- 4) Select the server type as SRT, which can output 2 SRTs at the same time. The optional handshake mode is Caller or Listener, and fill in the corresponding IP address, port, stream ID and password, as shown in the following figure:

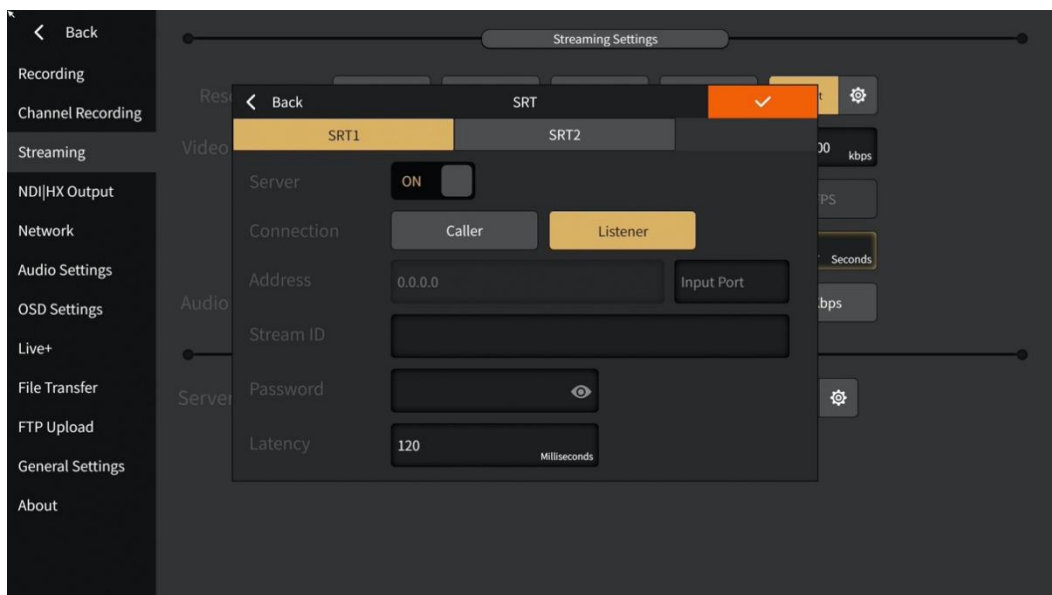

- 5) When you select Language for Chinese (Traditional)/English/German/Spanish, the server type can be selected from YouTube and Facebook, as shown below:

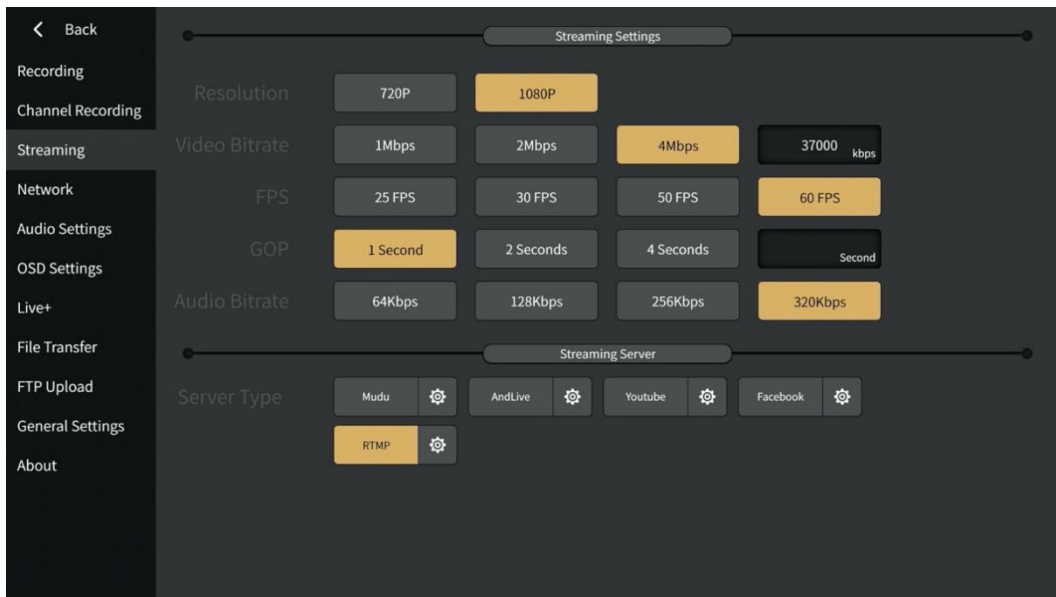

Select the corresponding setting button, fill in the rtmp address, account and password, the interface is shown below:

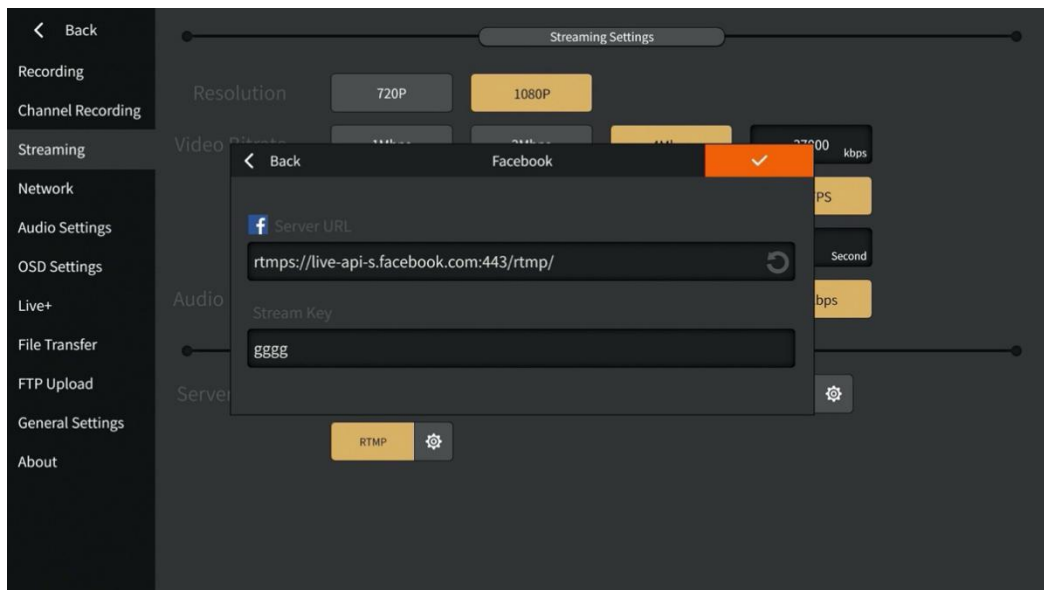

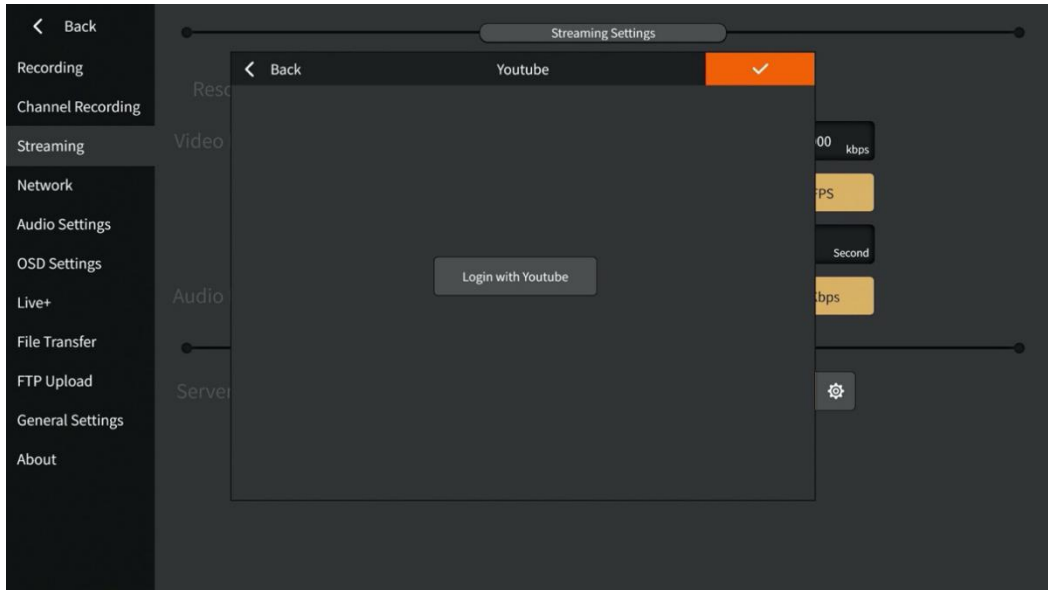

Note: How to stream to YouTube and Facebook, please refer to the instructions in the appendix.

3.2.4 NDI|HX Output

This module needs to be paid to add. You can choose NDI output source, output bitrate/bitrate mode, etc., as shown in the figure below:

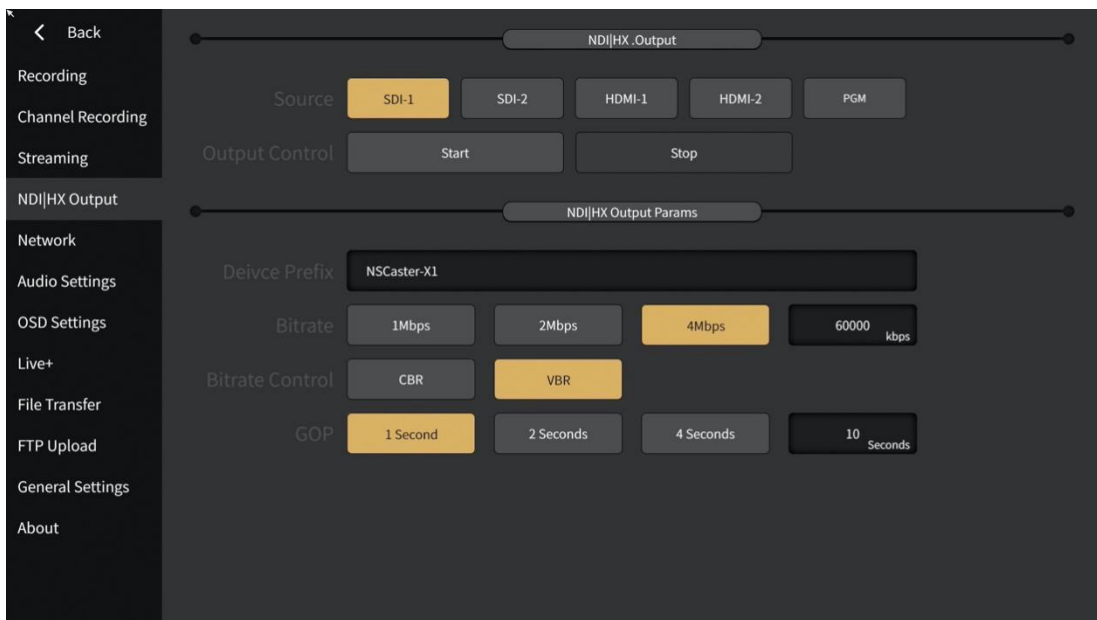

1. Output source: SDI1/SDI2/HDMI1/HDMI2/PGM signal output can be selected, single selection or multiple selections are available.
2. Output control: start/stop NDI output.
3. Output parameters: including display name prefix, bit rate, bit rate mode and interval frame.

3.2.5 Audio Settings

The following settings can be made for audio input and output:

1. XLR input: Noise can be eliminated, and the noise threshold can be manually adjusted. The larger the noise threshold, the smaller the noise heard. Channel copy can be performed, and mono channels can be changed to left and right channels through channel copy.
2. Analog output: control the volume of analog output.
3. Audio delay: The delay of physical input sound can be controlled to ensure video and audio synchronization.
4. Tuning configuration: audio follow can be set.

The setting interface is shown in the figure below:

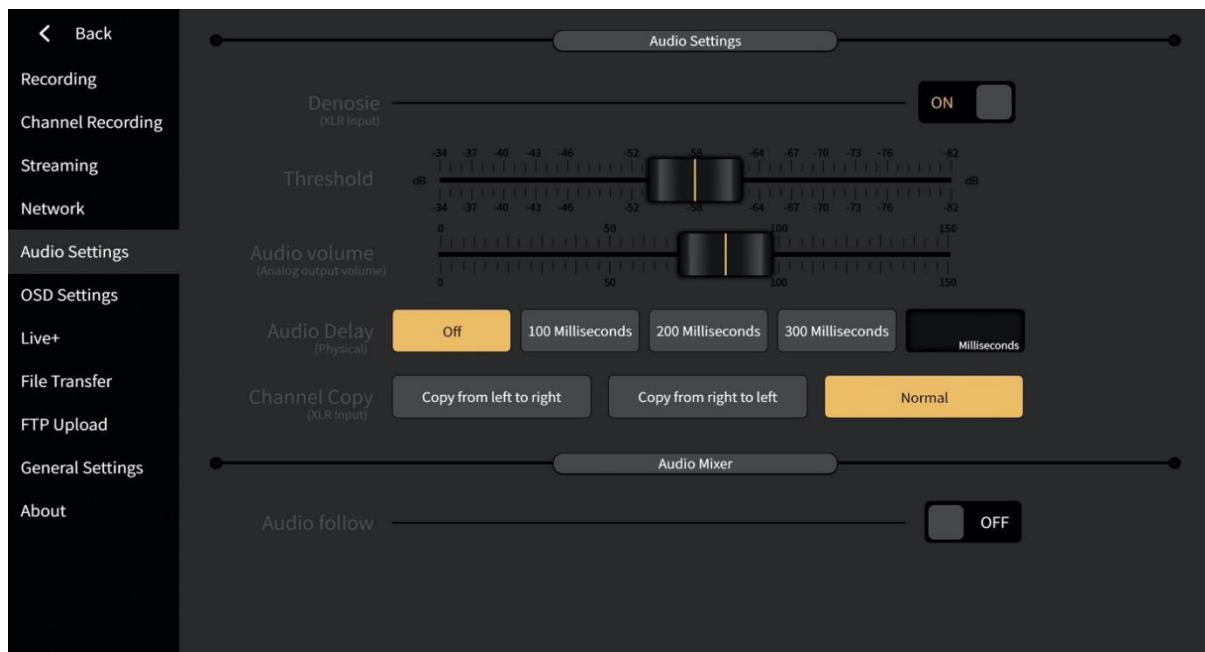

3.2.6 OSD Settings

It can support the display of the clock and OSD settings. The setting interface is shown below:

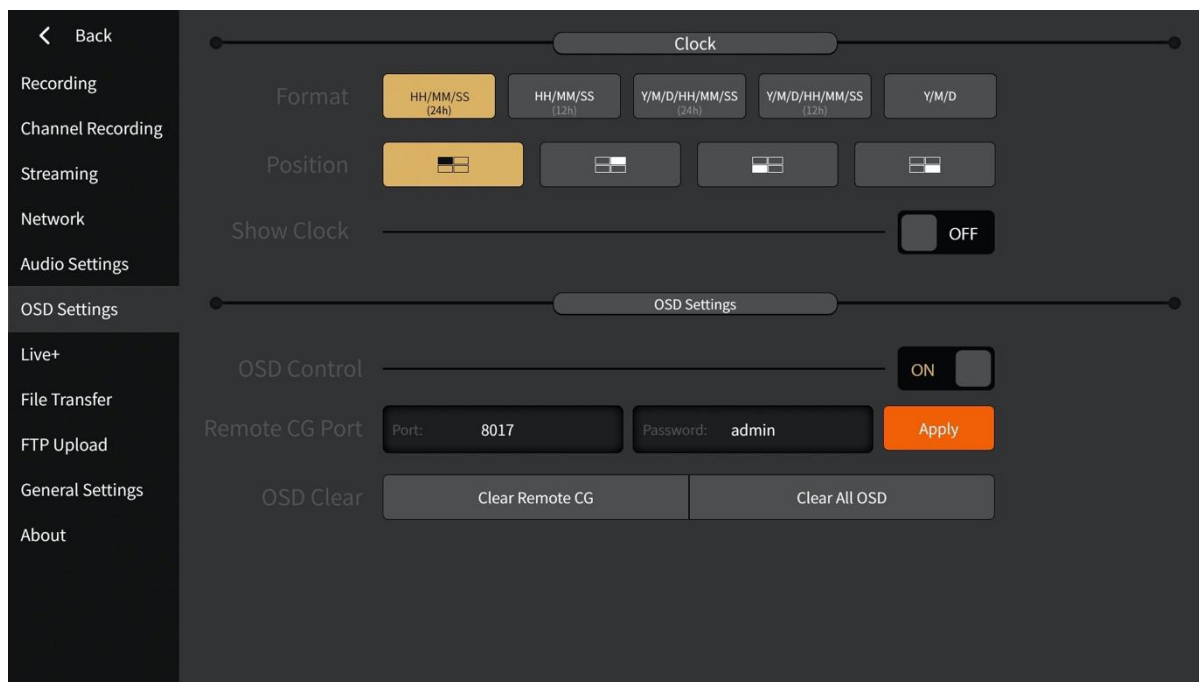

1) Clock Settings

Clock configuration status will let user know whether is on/off based on the status. If the status is “ON” means the clock is on right now and if the status is “OFF”, means that the clock is off. After being turned on, the current time can be displayed on the PGM monitor, and the format and the position of the clock support real-time switching as shown below:



2) Remote CG

Since this function needs to be used with the CG editor, the operation of the CG editor can be found in the appendix. Start the overlay function and set the remote CG port (default port 8017 / default password is admin), click Apply, as shown below:

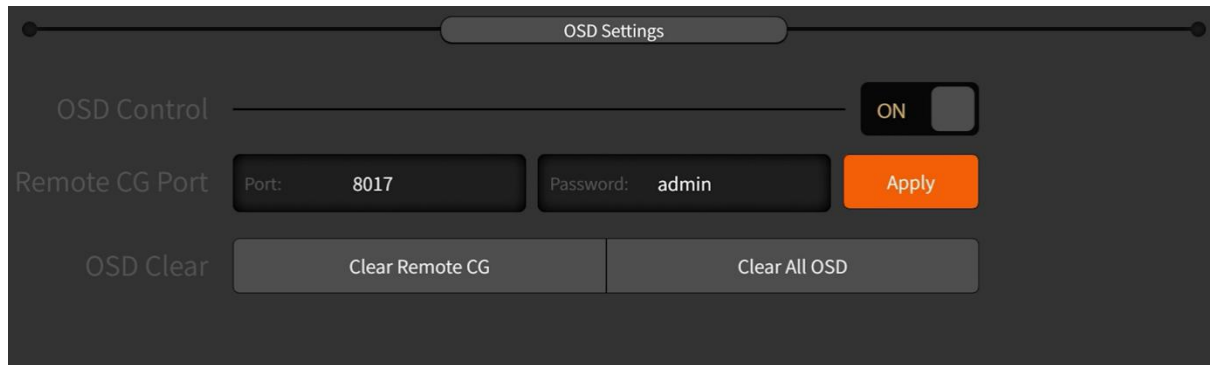

After connecting the NSCaster X1 and CG editor via the network, follow the operation buttons on the CG editor to overlay the CG content onto the PGM channel of NSCaster X1.

3) PGM OSD settings, the related operations are as follows:

Overlay control: when the switch is on, the picture / scoreboard / CG in PGM can be moved. Otherwise, it cannot be moved.

CG clear: clear the remote CG, clear the remote CG in the PGM; clear the PGM CG overlay, clear all OSD of the device itself.



3.2.7 Network

NSCaster-X1 supports ethernet, WIFI and 4G. The status of the connection  is displayed on the main interface, highlighted to indicate that it is connected.

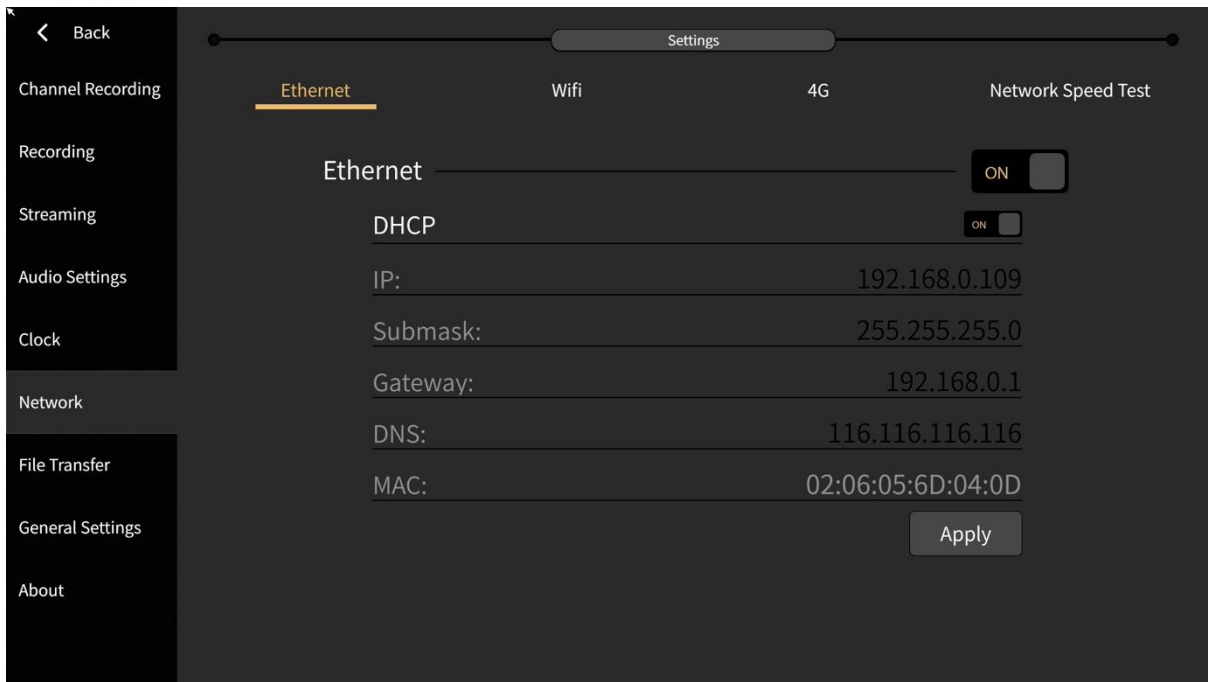
- 1) **Ethernet:** The default boot and the access network cable will automatically obtain the IP. Open DHCP and click "Apply" to get the IP address automatically, or turn off DHCP to manually modify the IP address as shown below:



Note: The standard version, the 4G Bonding version, and the Wireless Image Transmitter version all support wired networks.

- 2) **WIFI:** Select the WIFI you want to connect and enter the correct password. Click the button   to scroll up and down.

You can add hidden WiFi. Use the mobile phone to assist X1 to do WiFi login authentication; for WiFi that needs authentication, you can do WiFi authentication according to the steps given in the interface, as shown in the figure below:

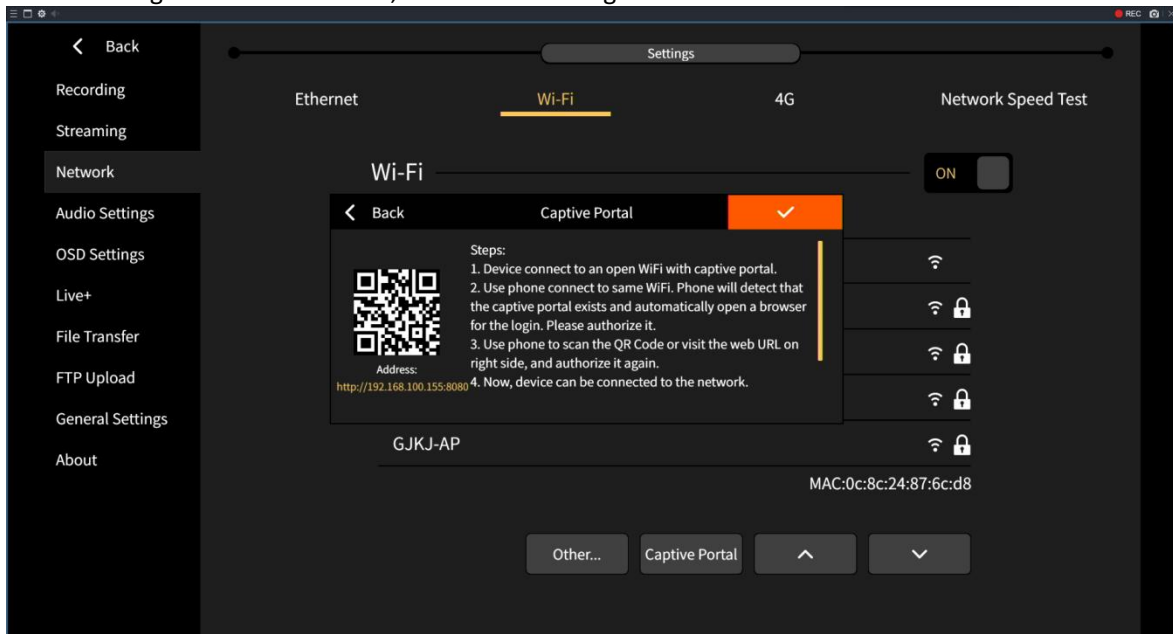

Note: The standard version, the 4G Bonding version, and the Wireless Image Transmitter version all support the wireless network setting interface.

- 3) **4G**: Click the start button and the status will be displayed as "ON". (Note: This interface does not affect the switch of the 4G bonding device. The 4G bonding device will automatically start the 4G network when it is inserted into the SIM card, and the 4G signal will be disconnected when the SIM card is pulled out.)

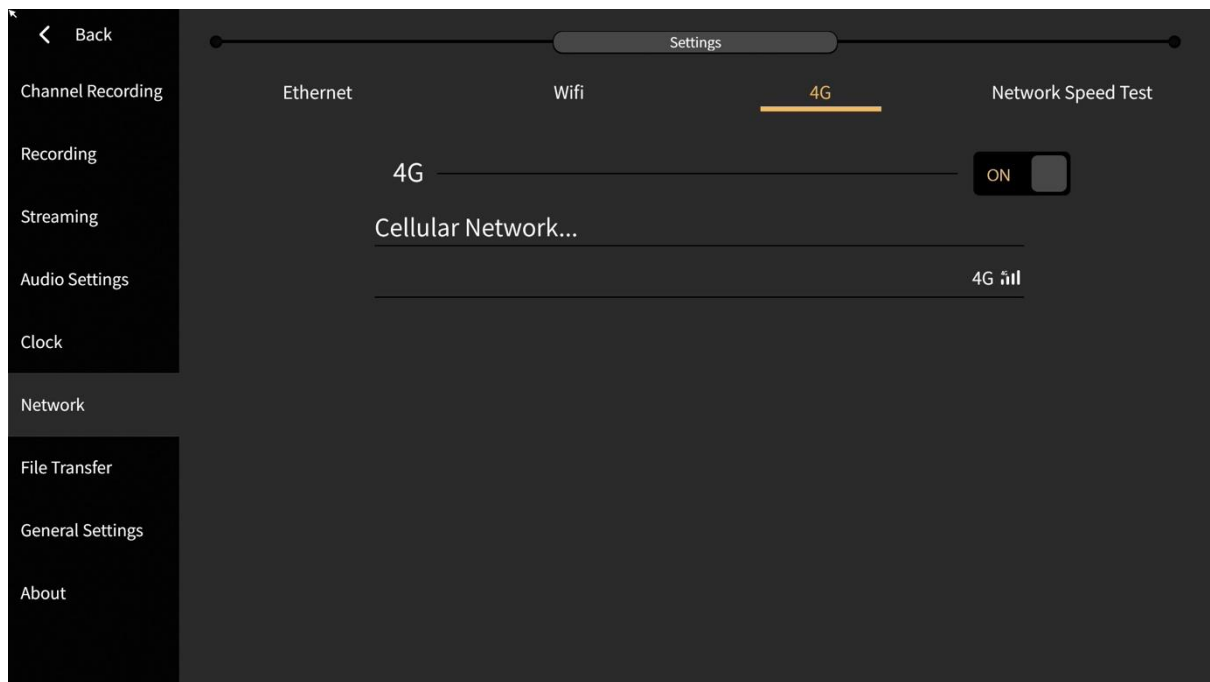

Note: Only the Standard version supports the Mobile Network Settings interface.

- 4) **4G Bonding network**: Supports the bonding function of different SIM cards. The setup interface is as follows:

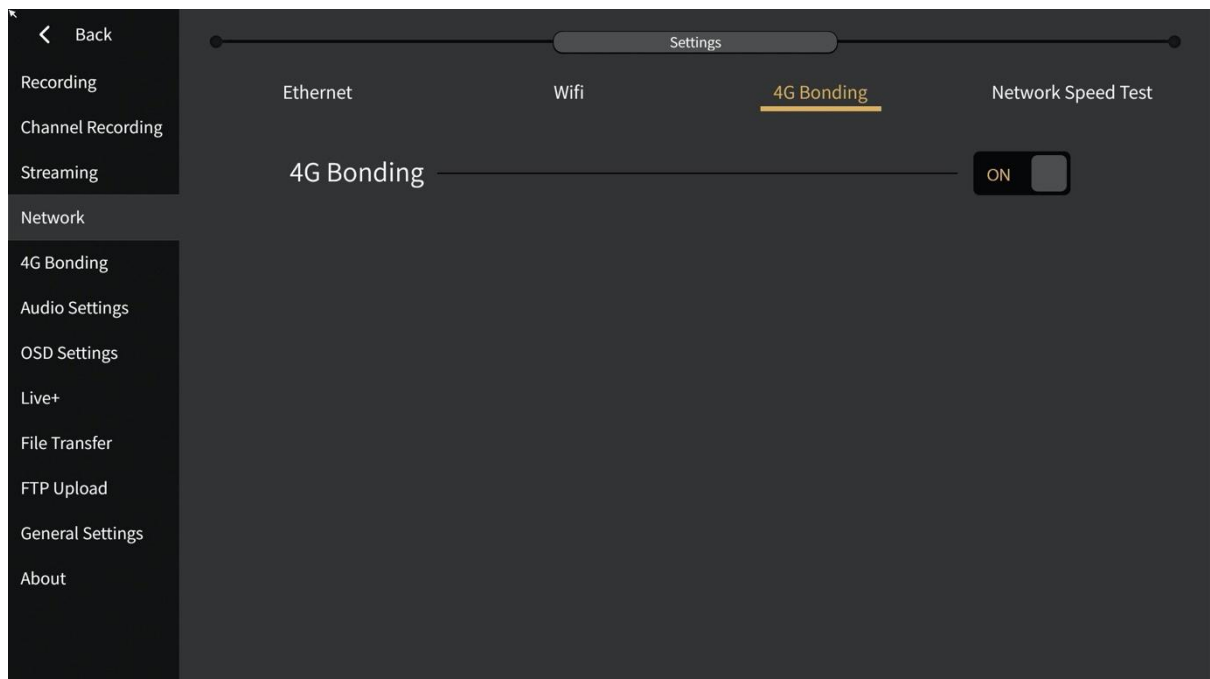

After the 4G bonding network is set to ON, you can enter the 4G bonding management interface.

- You can view the information such as uploading and downloading of the SIM card, as shown in the following figure:

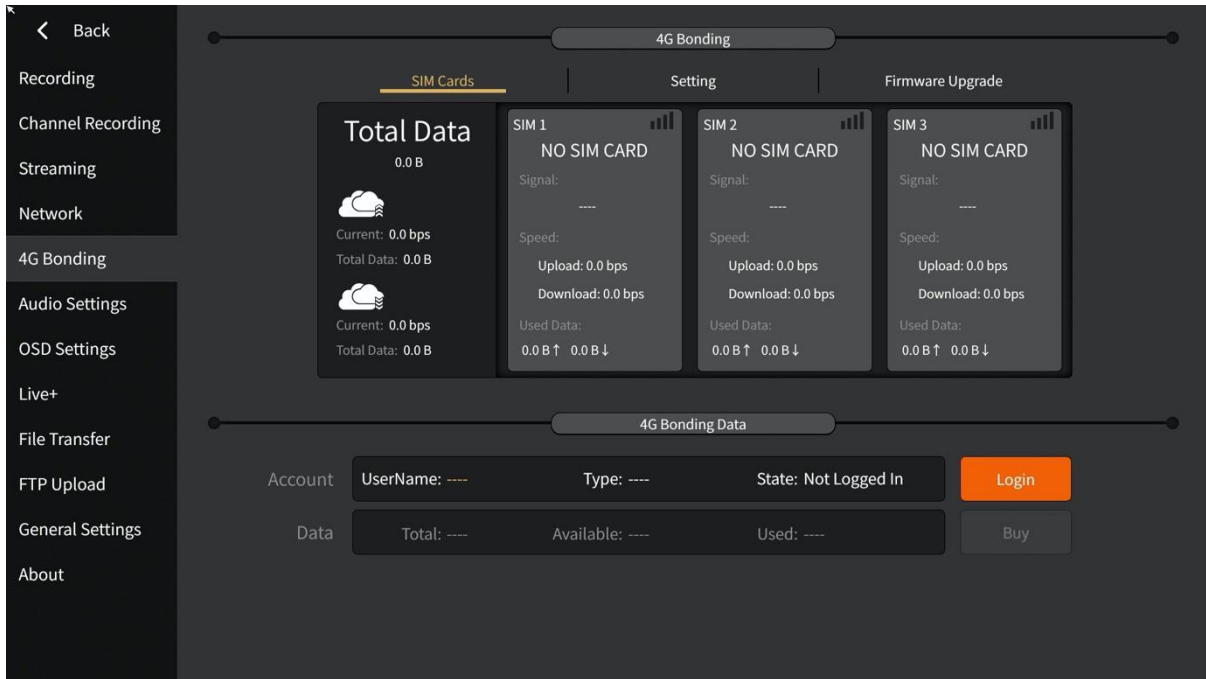

- It can set APN for SIM, as shown in the following figure:

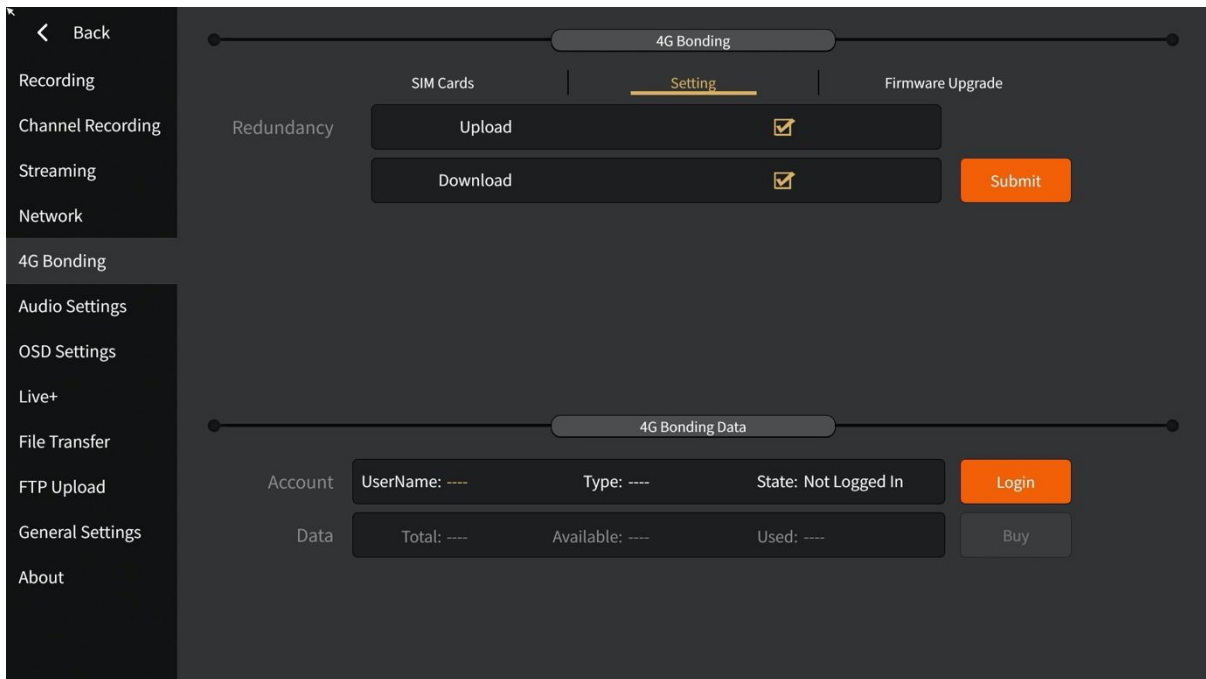

- The upgrade of the bonding module firmware can be performed as shown in the following figure:

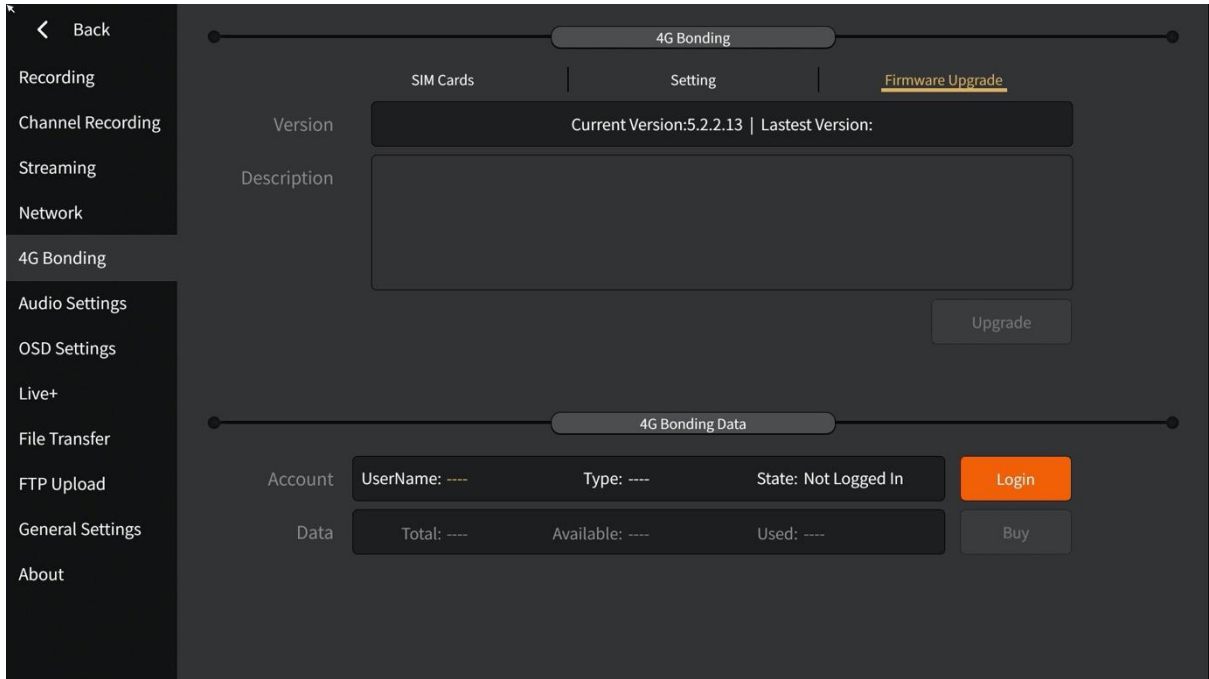

- Bonding can be used after logging in, and data can also be purchased online.

Note: Only the 4G bonding version supports 4G bonding management settings.

5) Network Speed Test

After connecting to the network, you can test the upload/download connection status of the network in real time, as shown in the following figure:

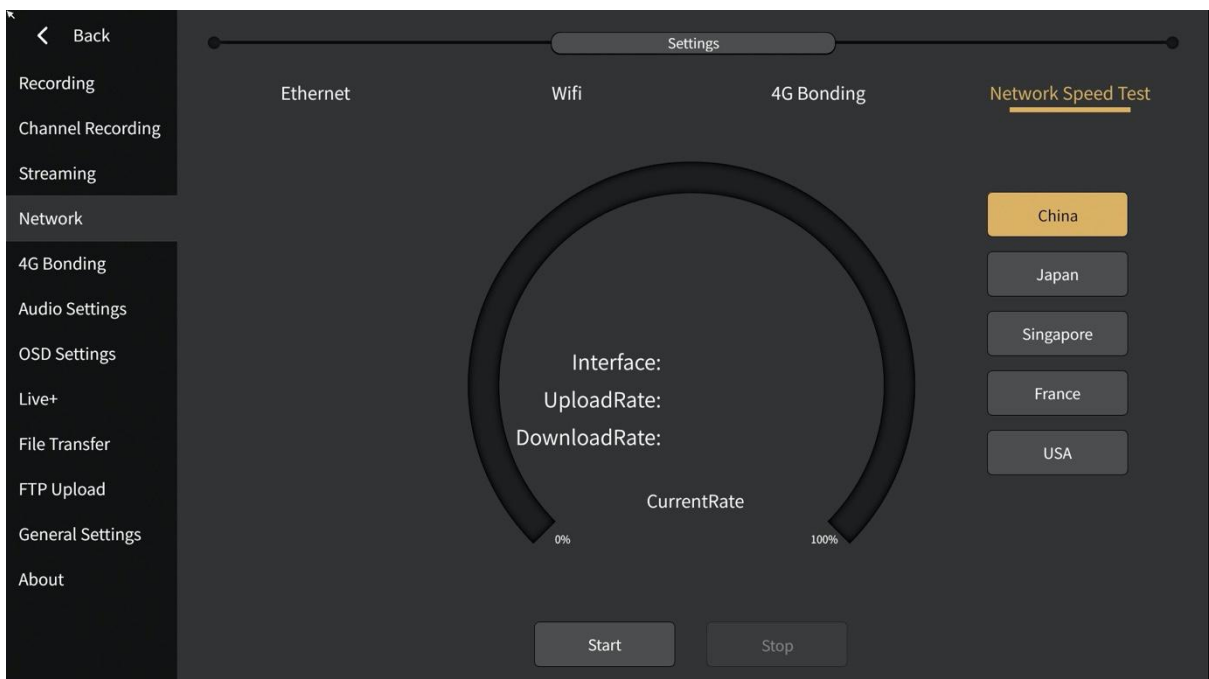

Remarks: The standard version, 4G bonding version, and Wireless Image Transmitter version all support the speed test function.

3.2.8 Live+

Use Live+ to make connected devices implement interactive functions and simple deployment. The setup interface is shown below:

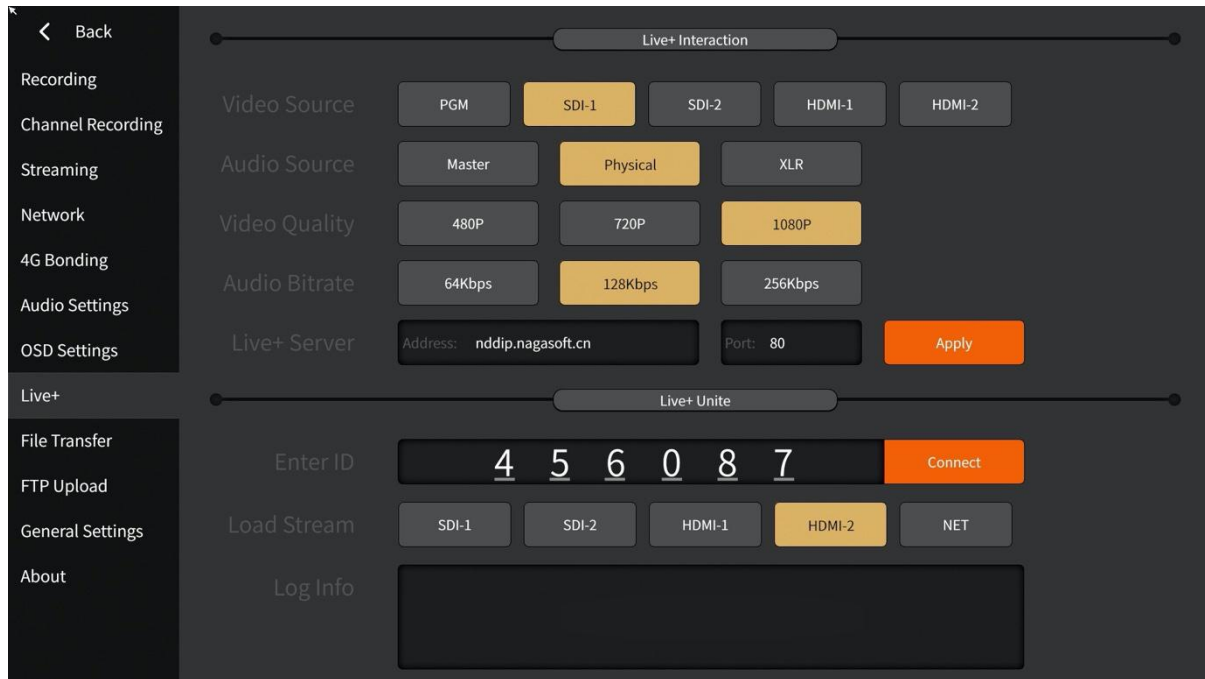

1) Live + interaction

It is used to set the interactive video and audio parameters that need to be output when it is used as an interactive source, mainly including the settings of video source, audio source, video quality, and audio bitrate. If a Live + service is deployed in the local area network, the server can be customized and port as shown below:



2) Live+ Unite

For connecting to the main venue, first you need to know the director ID of the main venue equipment (if it is NSCaster X1, you can select Live + device when the channel is

loaded), and then select the main venue screen to display on the channel when connected, as shown below:

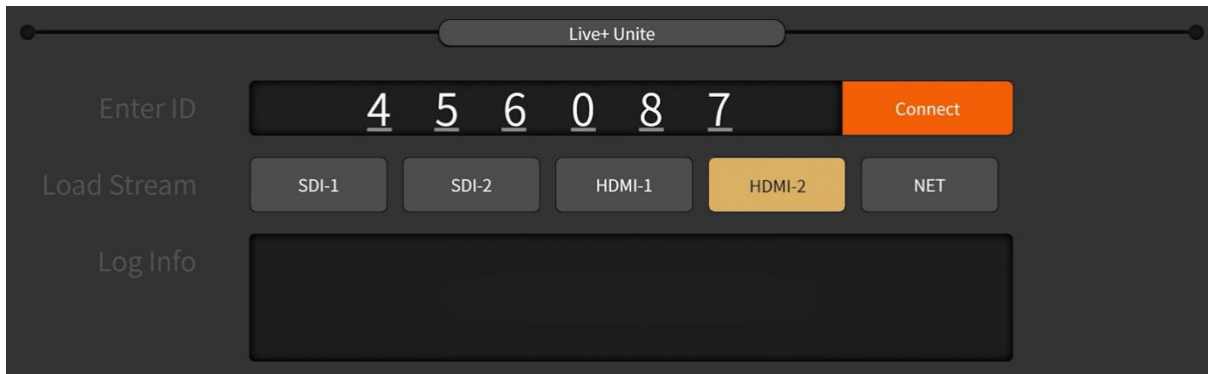

3.2.9 File Transfer

File transfer between local files and USB flash drives as shown below:

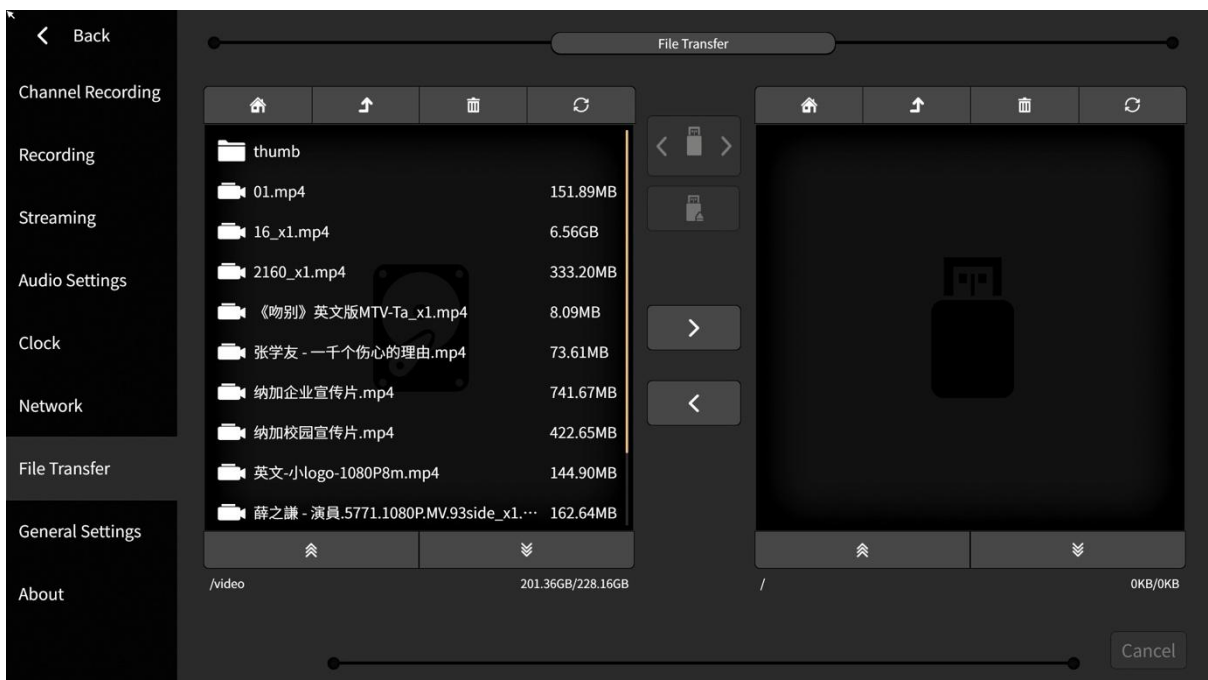





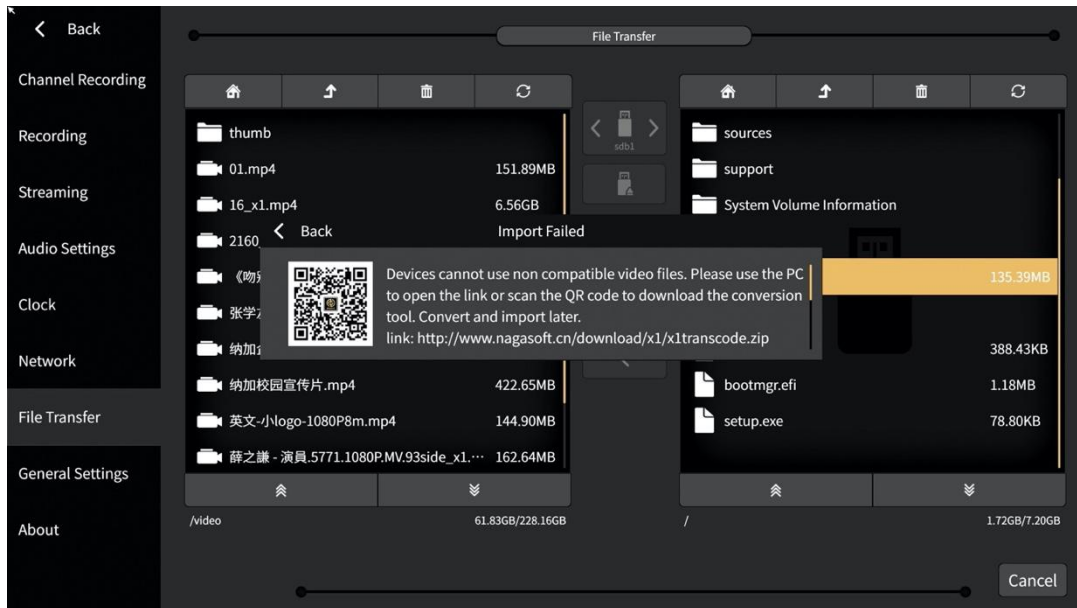



1) Local folder directory description:

- CG material: Store CG file
- Picture material: Store custom images, which can also be used for image overlay function and picture-in-picture custom template background.
- Recording: The "channel" folder stores channel recording files, "pgm" folder to store PGM recording files.
- Video material: Store DDR playback video. It only supports mp4 format and goes to B frame video, and if the format is incorrect, it will prompt "Import failed". (Solution: Download the transcoding tool to transcode the video, the link is: <http://cdn.nagasoft.cn/download/x1/x1transcode.zip>) as shown below:



- Font: stores the font set, which is used to set the font of characters. It supports OTF / TTF / TTC / TTF format. The imported fonts or deleted fonts need to restart the device to take effect. Note: different system languages need to find the corresponding language font set. For example, traditional characters use traditional font set.

2) The button operation is as follows:

- Button  : Return to the main interface directory of the file
- Button  : Return to the previous directory
- Button  : Delete files
- Button  : Refresh
- Button  : Choose a different USB flash drive/ different partitions of the same USB flash drive
- Button  : Slide up and down
- Button  : Copy locally to a USB flash drive
- Button  : Copy from USB flash drive to local
- Button  : During file copying, cancel the copy by the cancel button. Copy progress can refer to the percentage status of the progress bar.
- There are two ways to select a file: First is "single choice" which click on the corresponding file to select and the selected state is yellow highlighted. The second is "multiple selection" which long press the corresponding file or folder to select and the selected state is orange highlighted. To cancel the multi-select status, click the refresh button.

3.2.10 FTP Upload

FTP upload supports FTP / ftp / SFTP protocol, in which the default port of FTP / FTP is 21 and the default port of SFTP is 22. After filling in the host, port, user name and password of the FTP server, you can test whether the FTP connection is normal.

After setting, the recorded files will be automatically loaded into the upload queue for uploading; in the upload queue list, you can change the priority of the uploaded files, delete a single file, or clear the content of the upload queue. The setting interface is as follows:

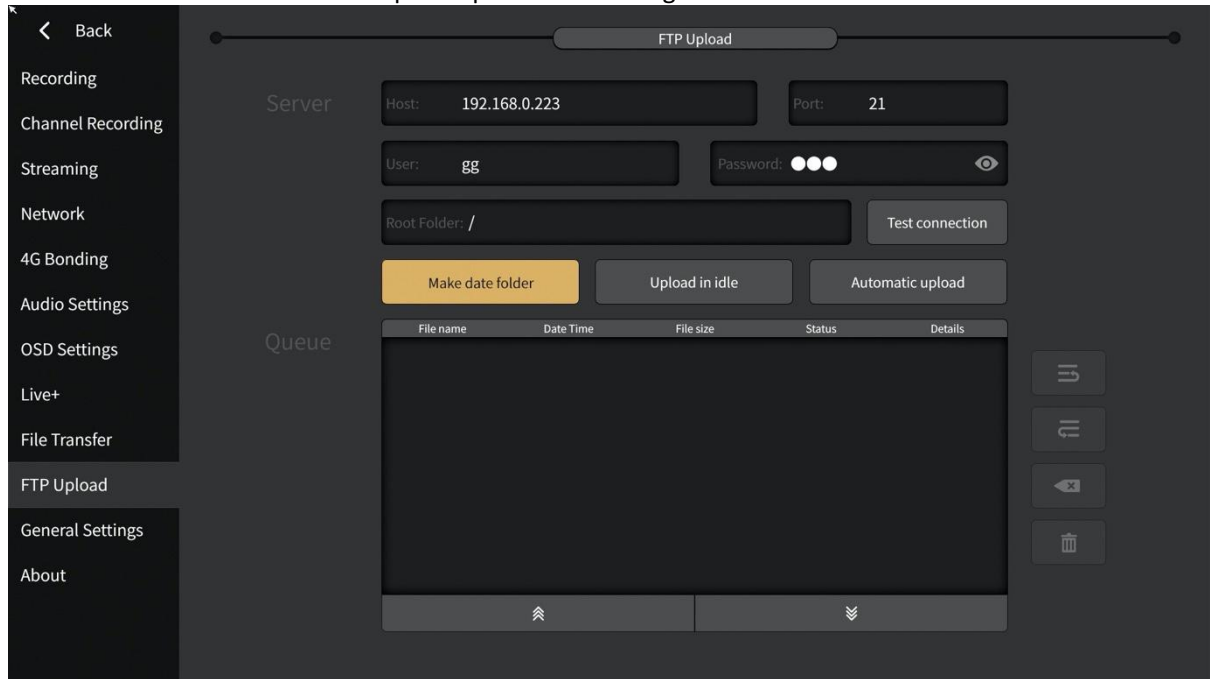

- Create date Directory: when uploading, the current date folder will be created automatically to store files. (if the user does not have permission to create a directory, the upload will fail)
- Upload in free time: when streaming and recording are stopped, it is free time.
- Delete uploaded local file: after uploading a recording file, delete the recording file in the "file copy record" folder.
- Automatic upload: automatically upload the files in the upload queue after it is turned on.

3.2.11 General Settings

The general configuration interface is divided into the following functions:

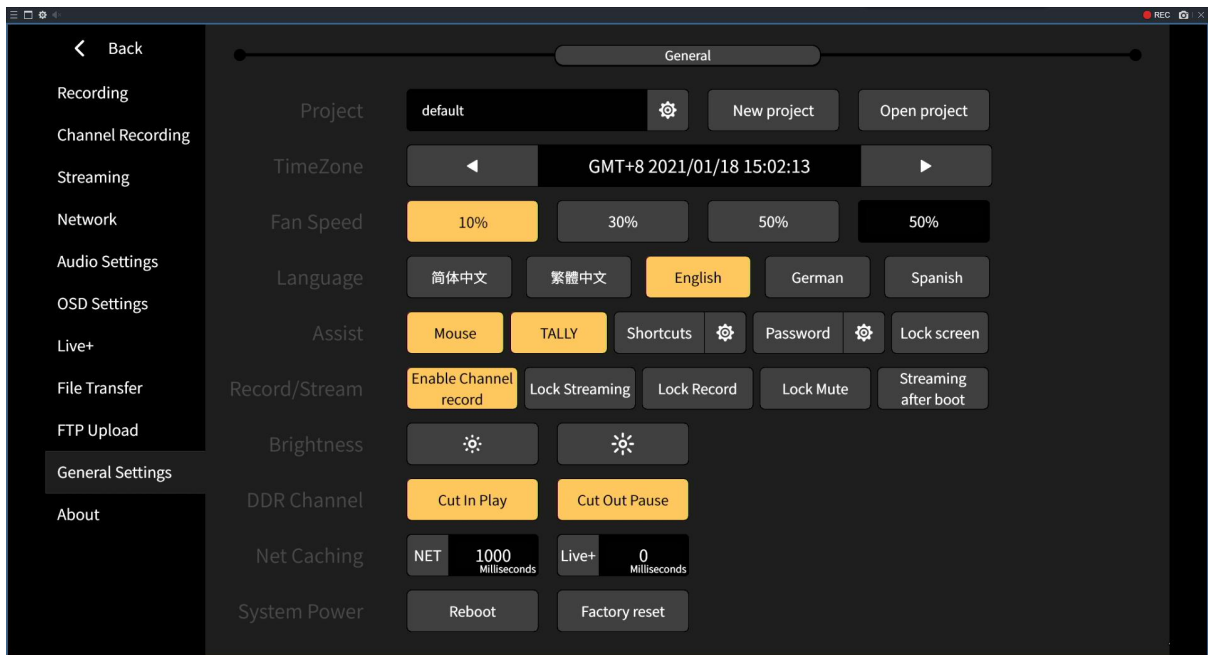

- 1) Project format: Support create, modify, delete and switch projects. It support 1080p25/30/50/60 standard. And the default project setting is 'default/25p'
 - A. New project: fill in the project name, select the standard and confirm the new project; the completed project will be displayed in the project list.
 - B. Click the  button to modify the properties of the current project. Switching mode belongs to the internal mode switching of the same project, and it needs to restart the program to switch successfully.
 - C. Open the project to view the project list. You can delete a single project from the list or clear all projects. The occupied projects are not in the project list and will not be affected by clearing.
 - D. Switch projects. For switching between different projects, select the project to be switched in the project list. Project switching will make other configured local parameters switch as well.

Note: switching project and switching mode need to restart the program to switch successfully.
- 2) TimeZone: The default is GMT + 8. Clicking the left (or right) key will decrease 1 (or increase 1) in the current time zone.
- 3) Fan speed: Control the fan speed (0-100%)
- 4) Language: Support real-time language switching (Simplified Chinese, Traditional Chinese, English, German).
- 5) Assist:
 - A. Mouse: enable/disable mouse to operate,
 - B. Tally: enable/disable Tally output
 - C. Shortcuts: use the keyboard to switch the PGM screen and operate the subtitle.
 - D. Device password: after it is enabled, you need to input the device password every time you start the machine. (if you forget the password, you can restore the factory settings or find technical support)
 - E. Lock screen: enter the device password to unlock.

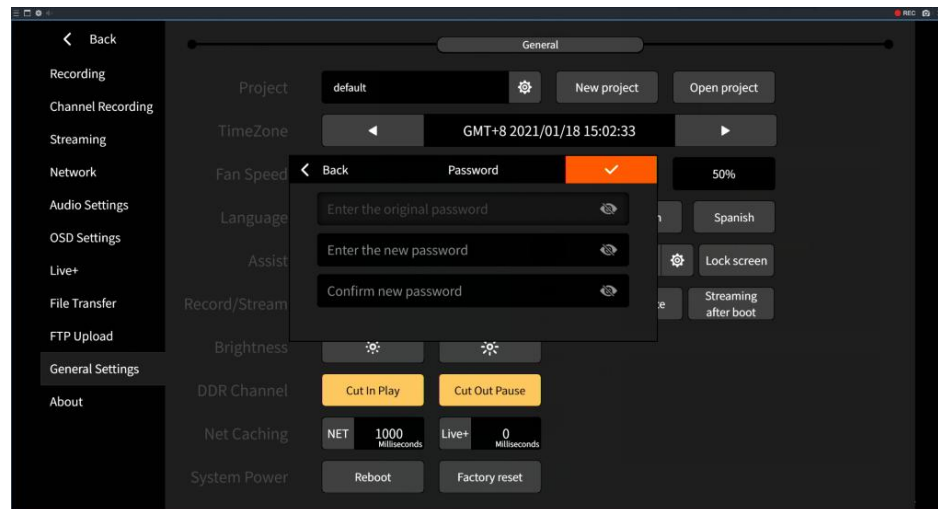

- 6) Record/Stream:
 - A. Enable channel recording: when enabled, the channel recording menu will appear. You can set the parameters related to channel recording. When it is not enabled, the menu will be hidden
 - B. Lock streaming: when enabled, the push stream button in the main interface is not used.
 - C. Lock record: when enabled, the 'record' button in the main interface is not used.
 - D. Lock mute: when enabled, the 'mute' button in the main interface is not used.
 - E. Streaming after boot: when enabled, the device will automatically stream after startup.
- 7) Brightness: You can adjust the screen brightness according to the actual scene.
- 8) DDR Channel: Can set the state of the video when the DDR channel is cut in and out.
- 9) Net Caching: Buffer time can be set for network flow and Live + connection, the unit is in ms. The default is 1000ms for network flow and 0ms for live + connection.
- 10) System Power: Reboot or restore factory settings. The factory reset will delete all user settings such as data, recorded videos, imported videos and pictures. After that, the device will restart.

3.2.12 About

The device information interface displays the details of the current device. In that interface, user can also do the software update and firmware update when there is available as shown below:

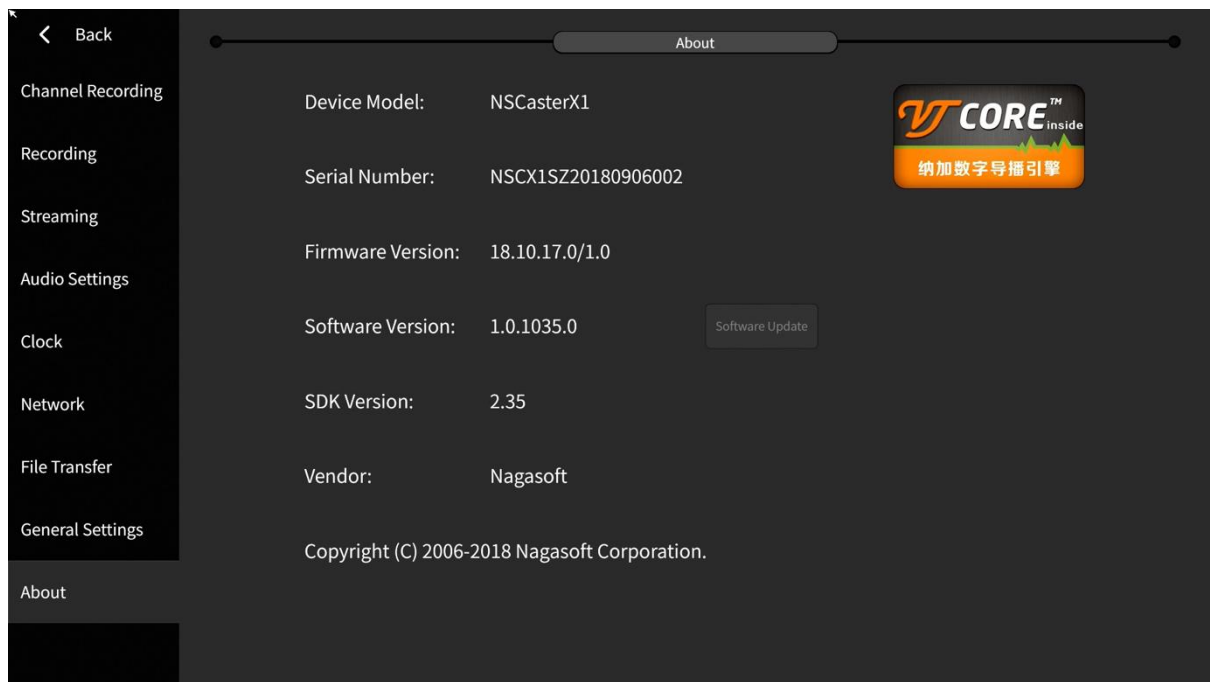

4 Questions and Answers

Q1. What should I do if the camera signal is not displayed?

Ans: NSCaster-X1 is automatically identify the input signal. HDMI input supports SD and HD all formats but for the SDI input, it only supports HD all-standard which means that it does not support SD. If the camera signal cannot be displayed, please confirm that the camera is turned on and make sure the camera is connected to the NSCaster-X1 device input port properly. If using SDI input, make

sure that it is not SD. If all of the above are normal, you can connect the camera to the monitor to check whether there is a signal or not. If all of the above are normal, please call us at 400-086-0078 for technical support.

Q2. What should I do if the live webcast is not stream?

Ans: First, use the network test function to test and make sure that the device is properly connected. After that, check the upload and download speed whether is normal or not. Then confirm whether the server address, port, and publishing point/flow name are correct.

Q3. What can I do if WIFI cannot connect?

Ans: First, check if the WIFI antenna is connected properly, then check if the 4G antenna is misused. After that, check if the WIFI is enabled in the software.

Q4. What can I do if 4G cannot connect?

Ans: First, check if the 4G SIM card is plugged in, then check the 4G antenna whether is connected or not and use the correct 4G antenna or not. After that, check if 4G is enabled in the software. If all of the above are normal, call 4G operator customer service to check if there is a balance on the 4G card.

Q5. What should I do if the device fails to boot?

Ans: First, check if the power is plugged in, and the power switch is pressed to the power-on position. If all of the above are normal, please call us at 400-086-0078 for technical support.

5 Appendix

5.1 YouTube Live Settings

Step 1: Create a live event on YouTube.

1. Enter (<http://www.youtube.com>) in your browser, click the "Sign In" button in the upper right corner of the page, and enter your account and password, as shown in the figure below:

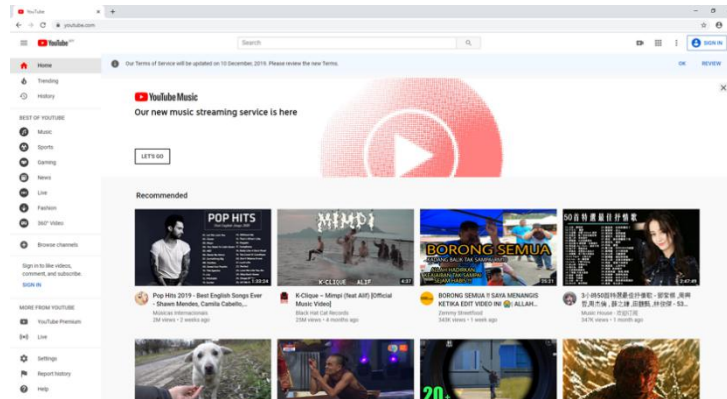
A screenshot of the YouTube sign-in form. It features the Google logo at the top, followed by the text 'Sign in to continue to YouTube'. Below this is a text input field labeled 'Email or phone'. There are links for 'Forgot email?' and 'Not your computer? Use Guest mode to sign in privately. Learn more'. At the bottom, there is a 'Create account' link and a blue 'Next' button.

English (United States) ▾

[Help](#) [Privacy](#) [Terms](#)

A screenshot of the YouTube password form. It features the Google logo at the top, followed by the text 'Welcome'. Below this is a dropdown menu showing the email address 'nagashare4u@gmail.com'. There is a text input field labeled 'Enter your password' with a visibility toggle icon. There are links for 'Forgot password?' and a blue 'Next' button.

English (United States) ▾

[Help](#) [Privacy](#) [Terms](#)

- After login, select the YouTube Studio function to enter its setting interface, as shown in the figure below:

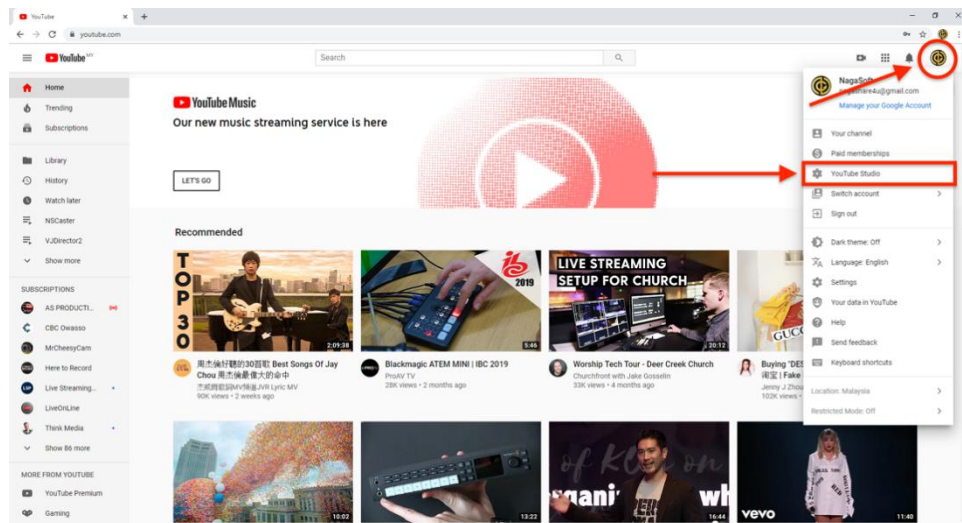

- Click the Live icon and select "Events" to create a live event, as shown below:

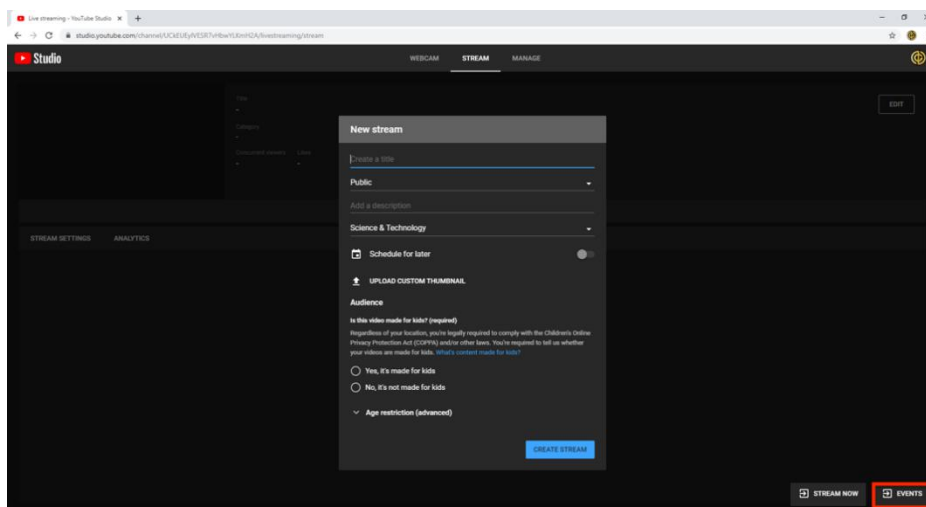
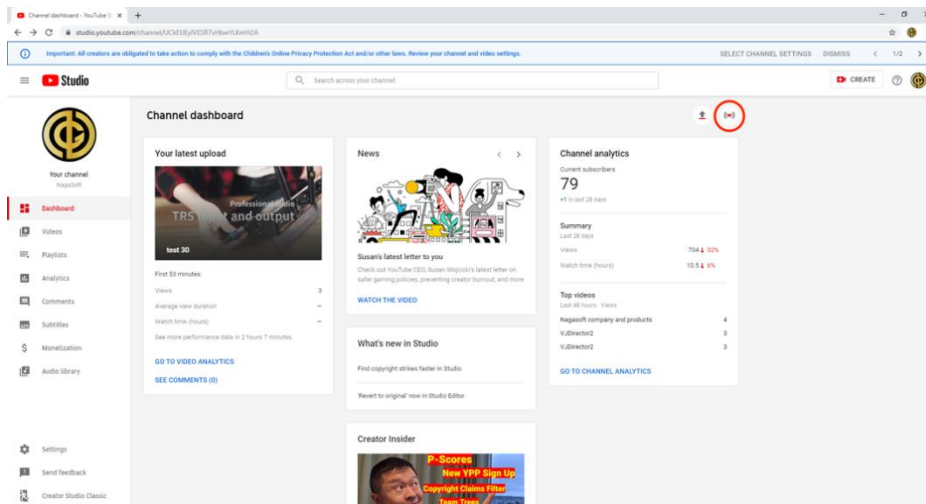

4. In the setting interface, click "New Live Event" to start creating a new live event, as shown in the figure below:

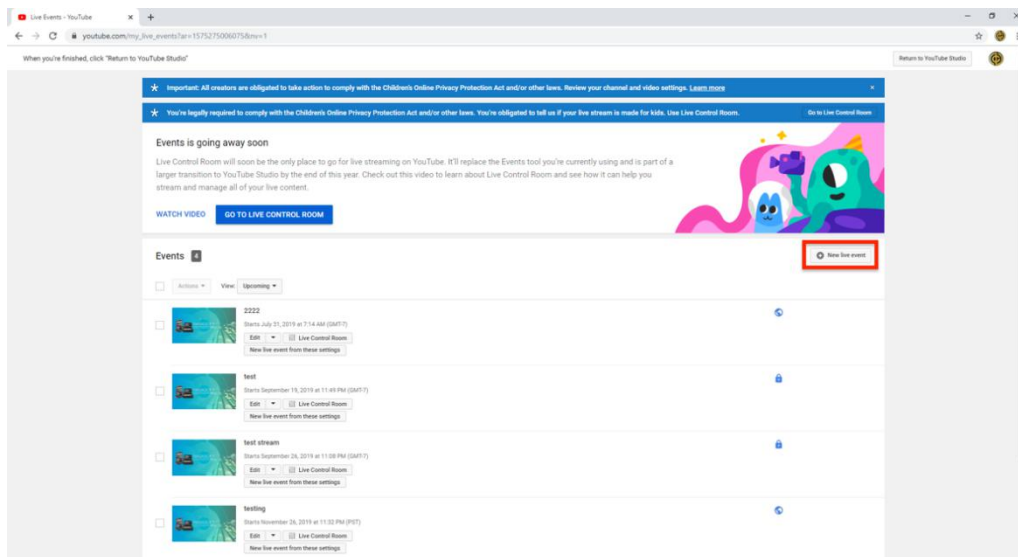

5. Write the name of the live event and the start time. Keep the other settings as default. Once you done, click "Create event" to create a new live event, as shown in the figure below:

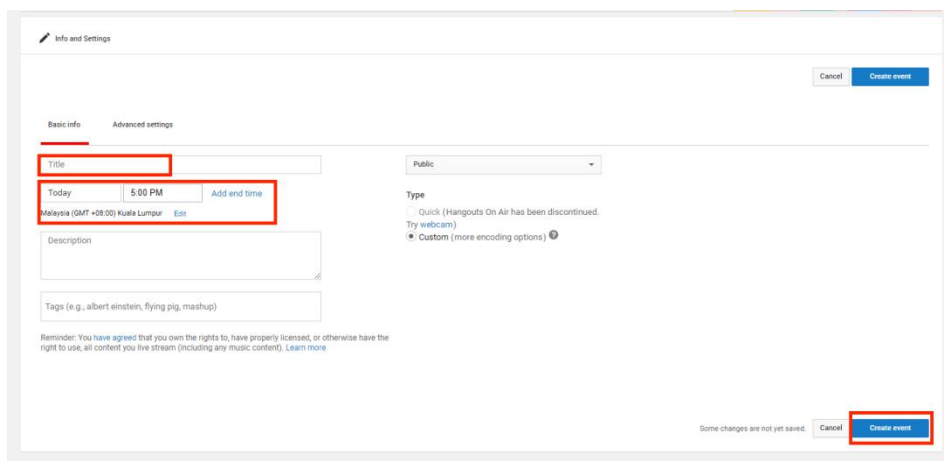

6. After creating the event, set the resolution and frame rate for the event. Select "Reusable Stream Key" in "Main Camera", and click "Create New Stream", as shown below:

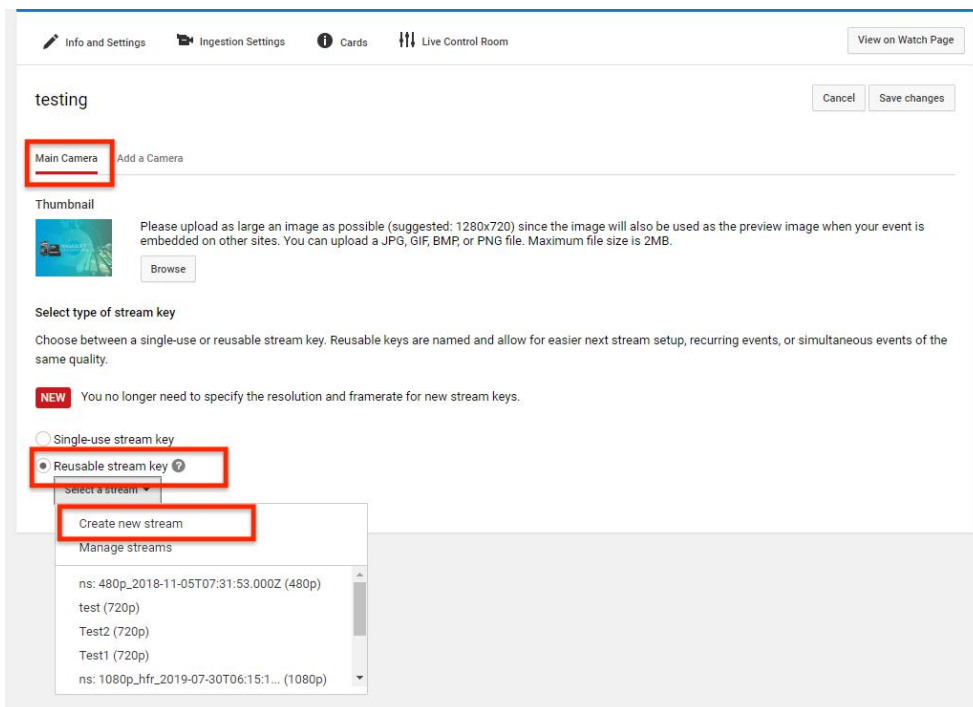

7. In the new video stream setting interface, write the "Name" and "Description", select "Variable (beta)" for maximum continuous bitrate, and click Save, as shown in the figure below:

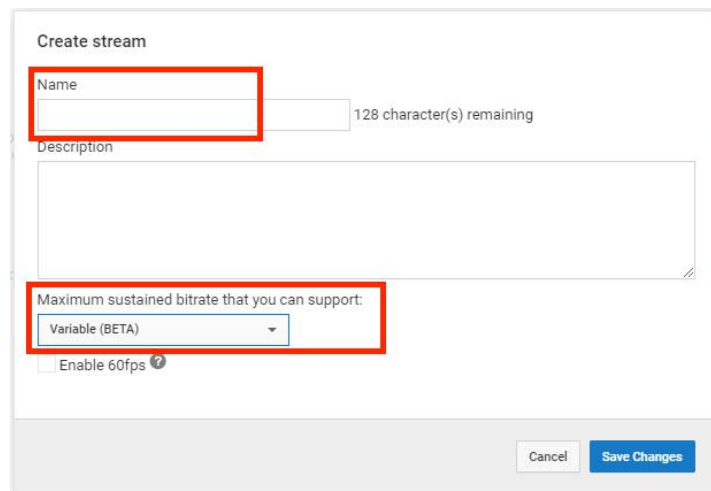

8. Select the "Video Stream Key" set in the previous step and other parameters are default. Click "Save Changes" to create a live event.

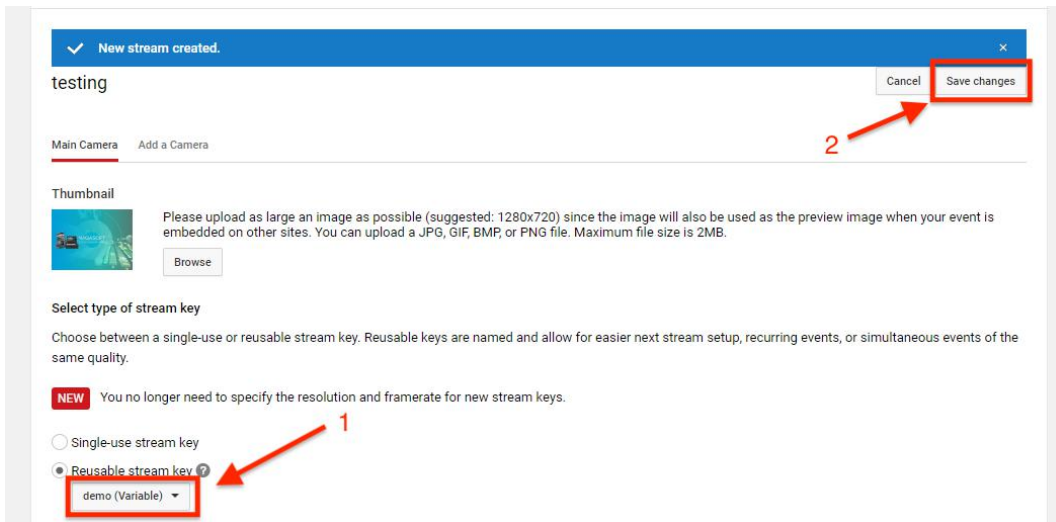

Step 2: Use NSCaster X1 to stream to YouTube

1. In the setting interface of X1, select "Streaming" and select YouTube, as shown in the figure below:

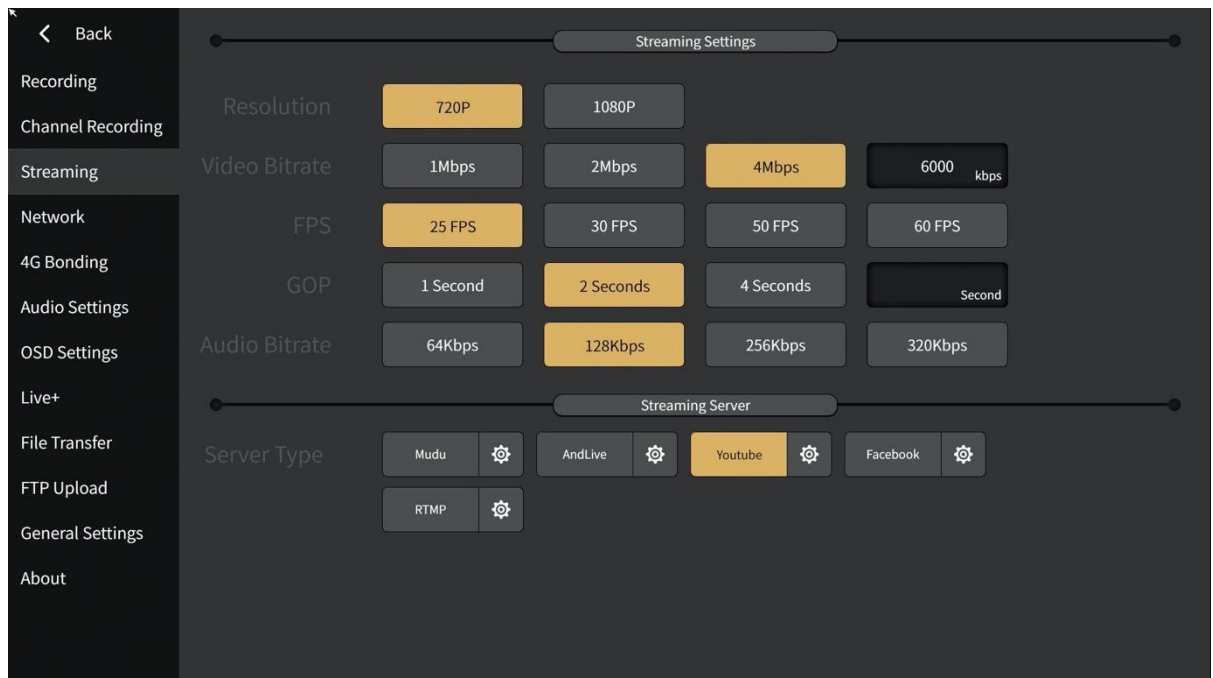

2. Click the settings button of YouTube to enter the YouTube login interface, as shown in the figure below:

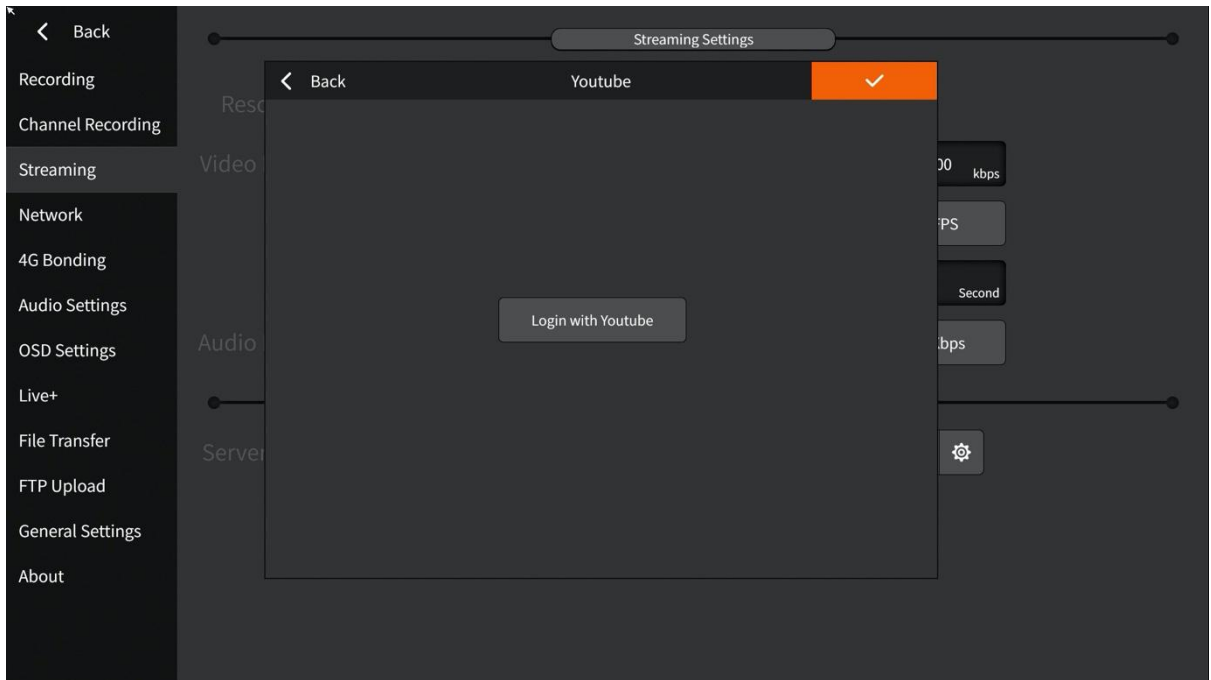

3. After entering the account and password, enter the live event setting interface, as shown below:

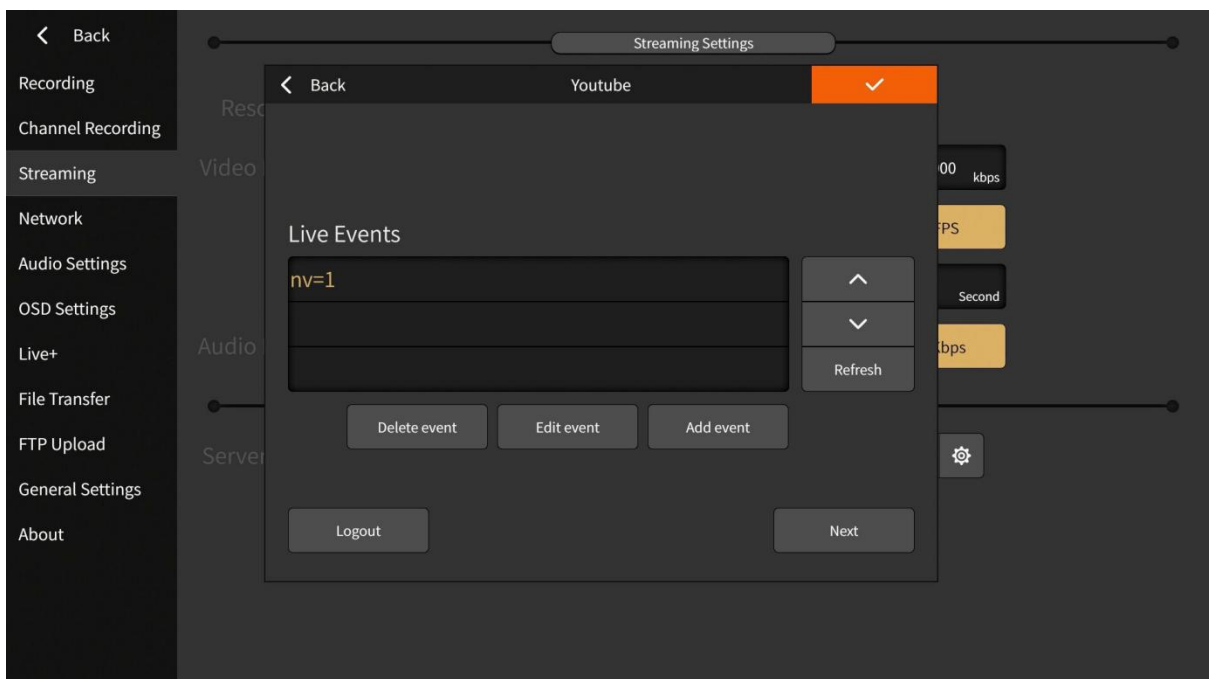

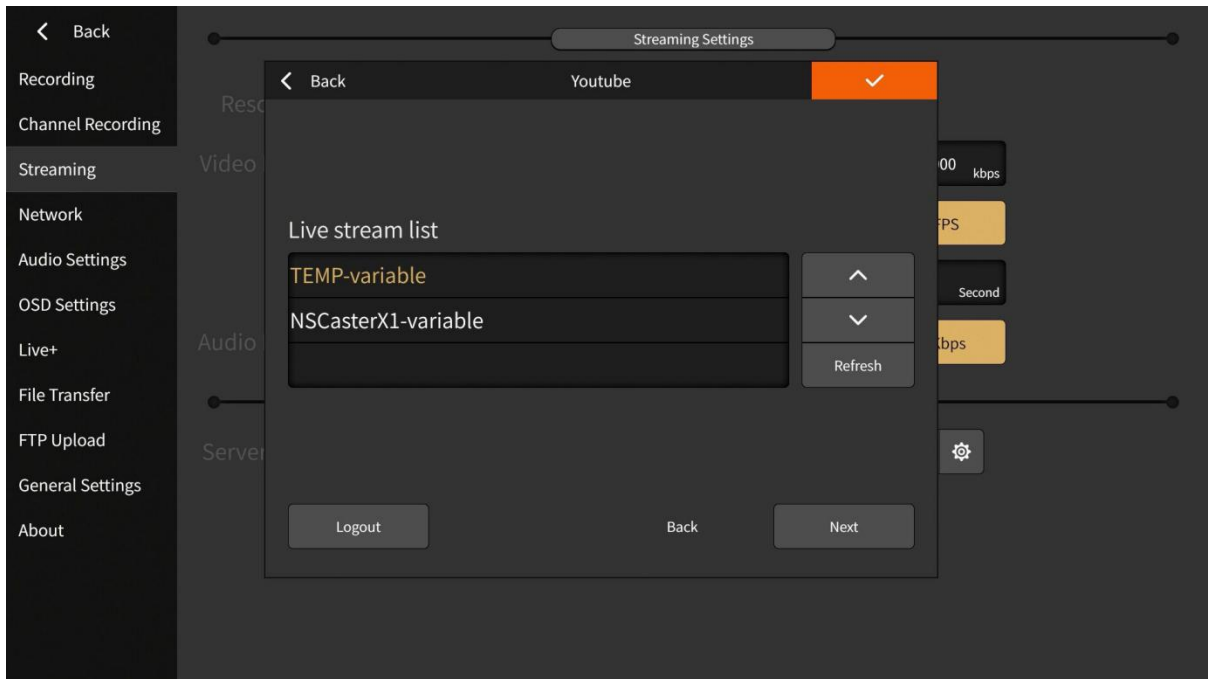

Select the live event created in step one, such as "nv=1", and click "Next".

4. Select the video stream parameters corresponding to the live event. For example, the TEMP set in step 1 is the "TEMP-variable", and click Next after selection as shown below:

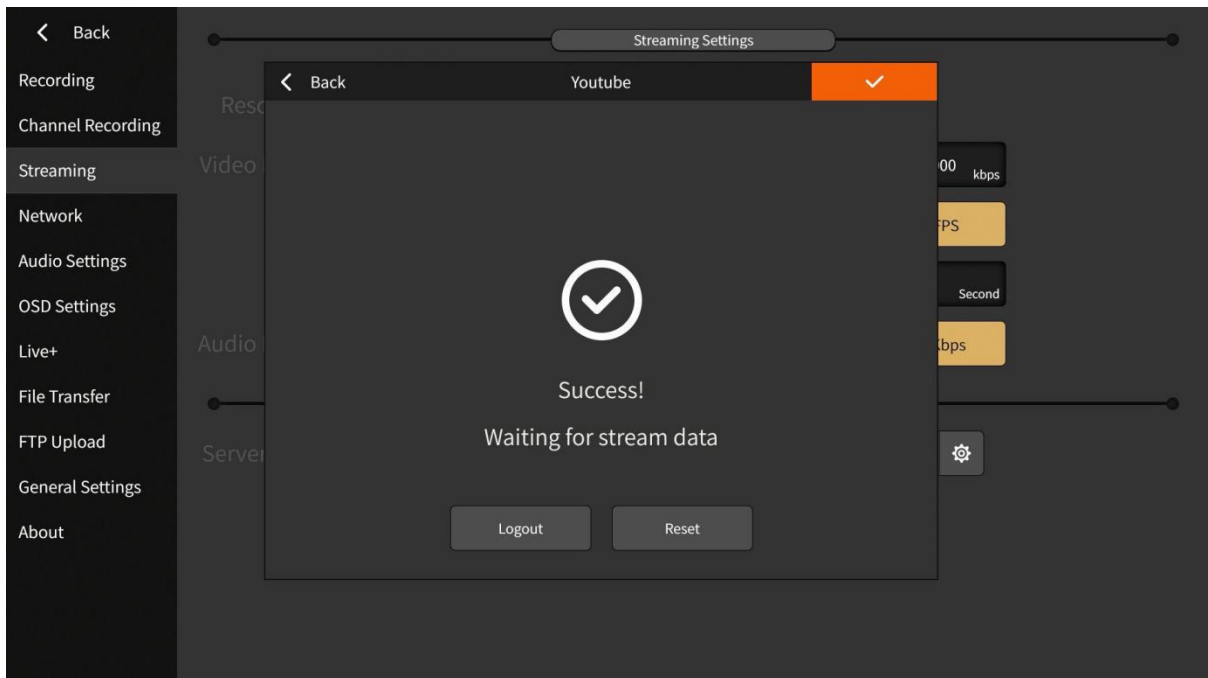

5. After the setting is successful, the message "The live broadcast has been successfully created, waiting for streaming ..." is displayed, indicating that the live broadcast setting parameters have been completed and waiting to start streaming.



Click  to confirm that the setting is complete. Do not click Reset Live.

6. After the setting is completed, click the cloud button, and observe the upload speed to determine whether the stream is normal.

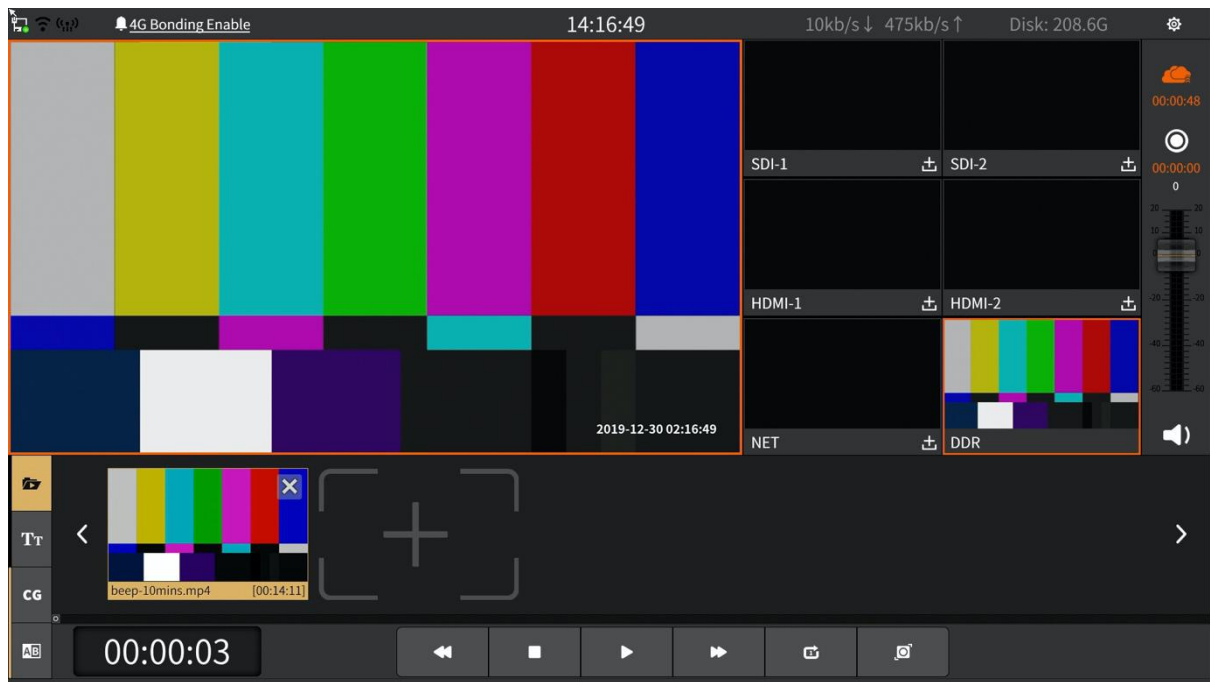

Step 3: Watch live on YouTube.

After logging in, you can watch the live broadcast on the corresponding playback page.

5.2 Facebook Live Settings

Step 1: Use NSCaster X1 to stream to Facebook

1. In the setting interface of X1, select "Streaming" and select Facebook, as shown in the figure below:



2. Click the Facebook settings button to enter the Facebook login interface, as shown below:

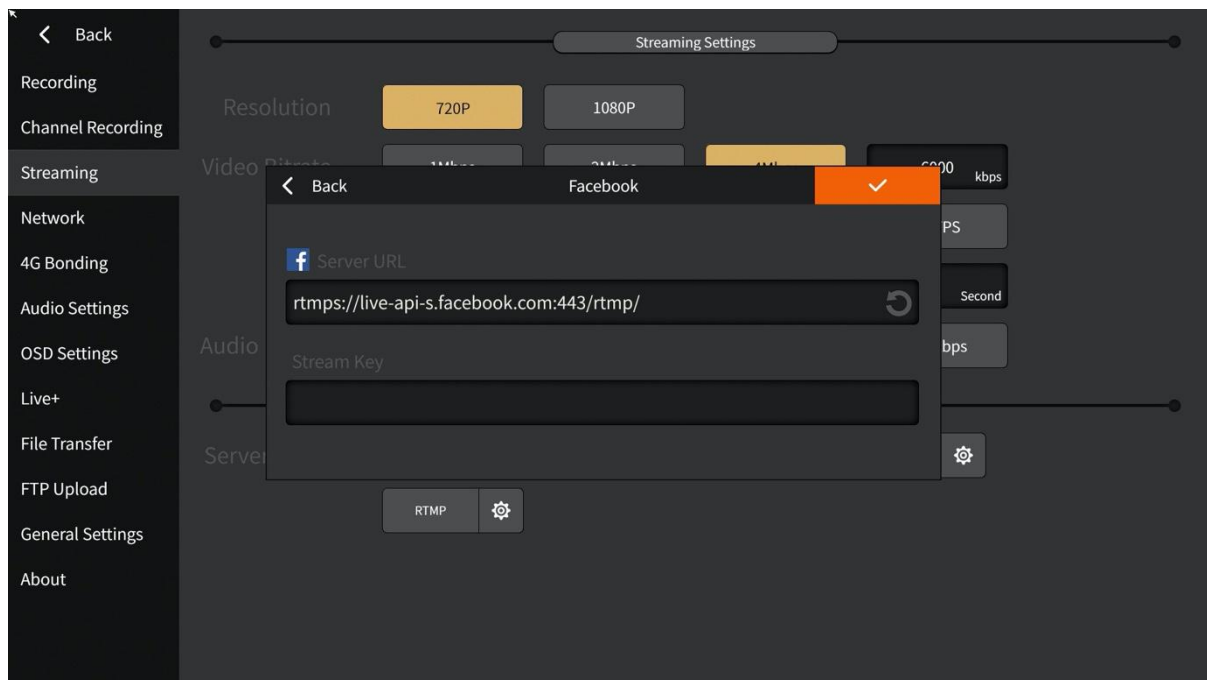

3. Enter your Facebook Server URL and Stream Key from Facebook.
4. After the setting is completed, click the cloud button, and observe the upload speed to determine whether the stream is normal, as shown in the figure:

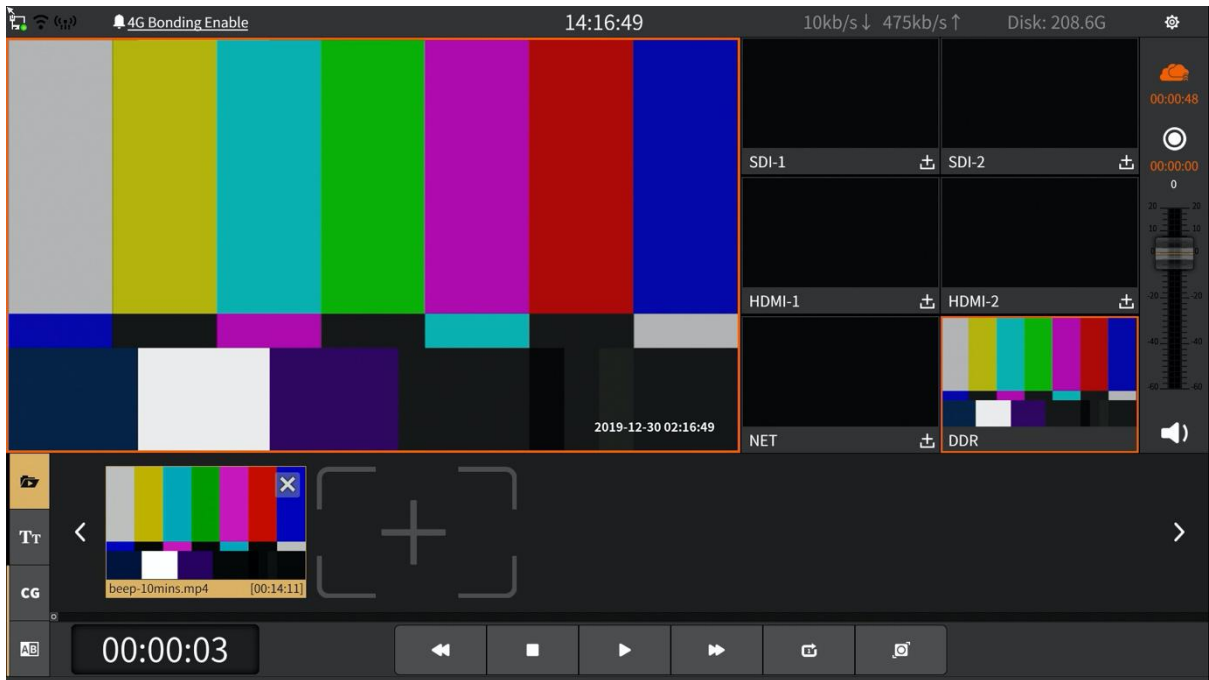

Step 2: Log in to Facebook

1. Facebook page, as shown below:



2. Refresh the login account page, you can see the live broadcast screen later, as shown below:



5.3 CG Editor Operation

5.3.1 Interface

1. Project setting interface

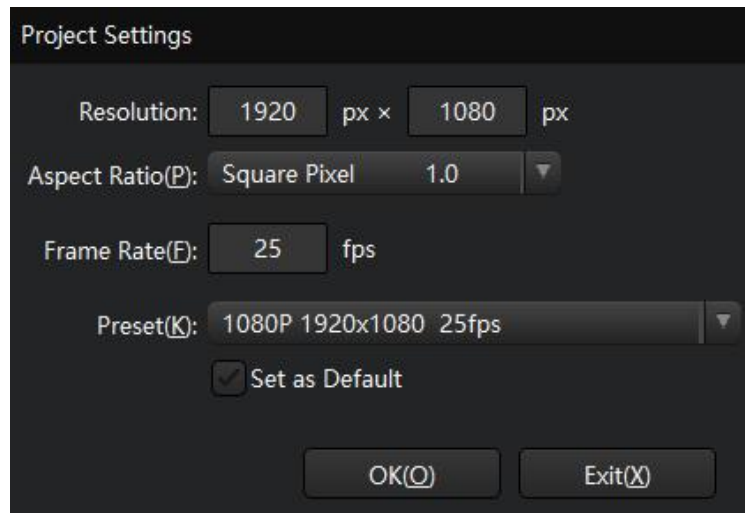

Usually select the "Preset".

2. Main interface

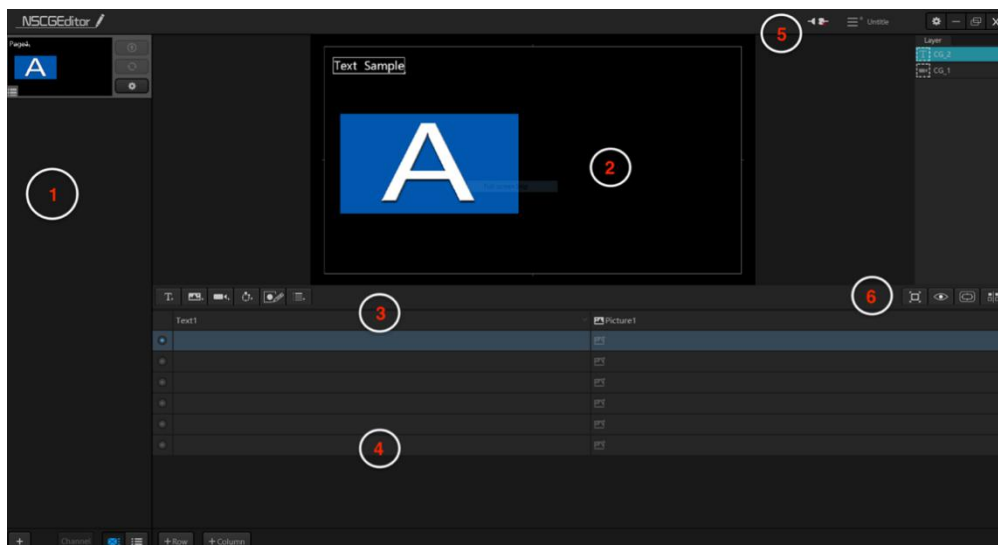

- 1) CG page management area
- 2) Work area
- 3) Element selection area
- 4) Data operation area
- 5) System setting area
- 6) Display area

5.3.2 Remote Publishing

Before remote publishing, you need to connect the CG editor and NSCaster together to publish CG remotely. In the system settings area, click  to configure, as shown below:

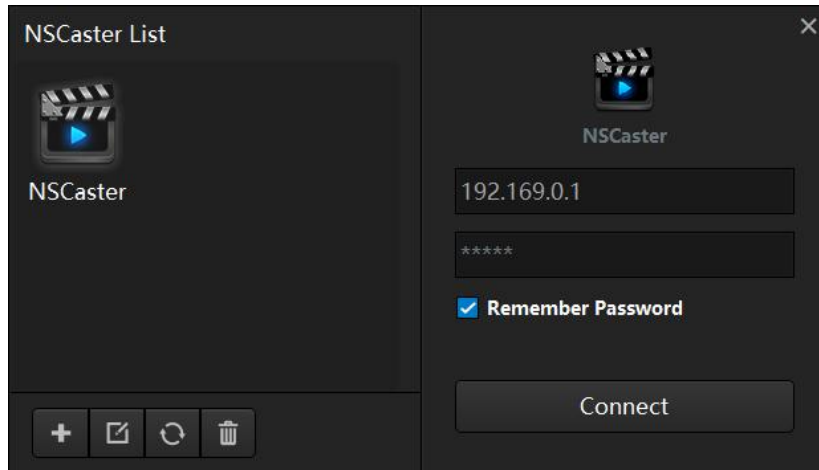

Click  to add the NSCaster that needs to publish CG remotely, and fill in the name (custom), IP, and the password (default is admin), as shown in the figure below:

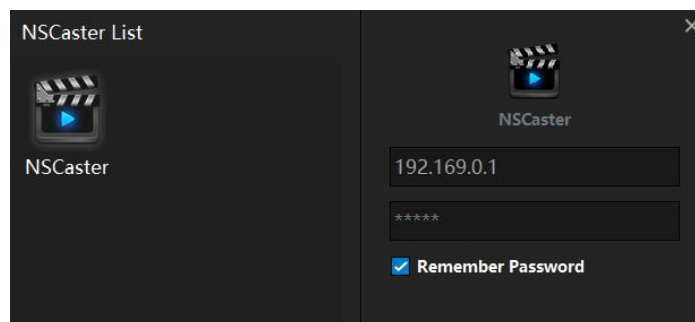

After the addition is complete, select the added NSCaster in the NSCaster list, and then click Connect.

5.3.3 CG Page

In the CG page management area, click **+** to create a new CG page or open existing CG file (a CG file can contain one or more CG pages). The data source can support EXCEL table or RRS. At the same time, the CG page can be displayed in the corresponding channel.

1. CG Page Operation

Click the **[+]** icon in the CG page management area to select a new CG page (including Excel/RSS/blank CG page). The operation interface is shown below:

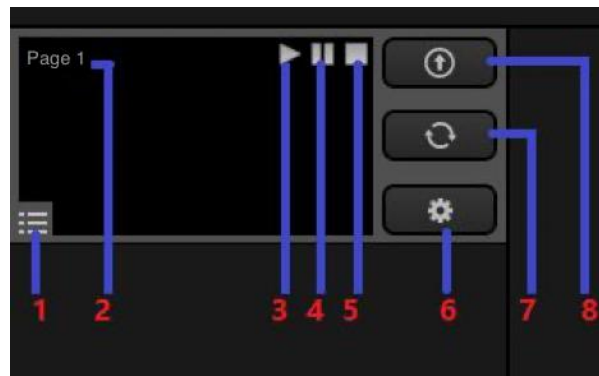

- 1) Page status
- 2) Page name (Optional)
- 3) Play a remote CG
- 4) Pause a remote CG
- 5) Stop remote CG
- 6) CG page settings
- 7) Update CG
- 8) Publish/Unpublish CG
- 9) Right-click on a CG page to optionally delete the page

2. CG Page Settings

Create a new CG page, and click the setting button to pop up the setting interface. The interface is shown below:

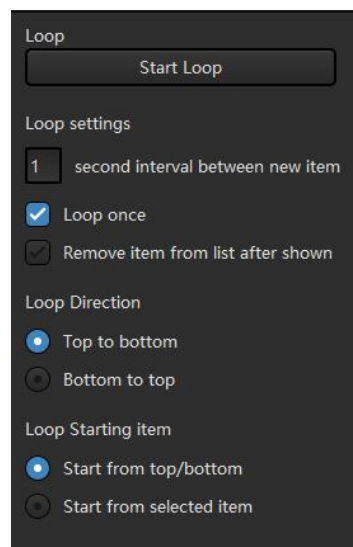

- 1) Loop Settings: Loop once and loop based on timing.
- 2) Loop Direction: Top to bottom and Bottom to top.
- 3) Loop Starting Item: Start from top, start from bottom, start from selected item.
- 4) After the loop parameter setting is completed, click Start to perform loop playback.

3. CG Page Specified Display

The CG can be specified into the corresponding channel, as shown in the figure below:

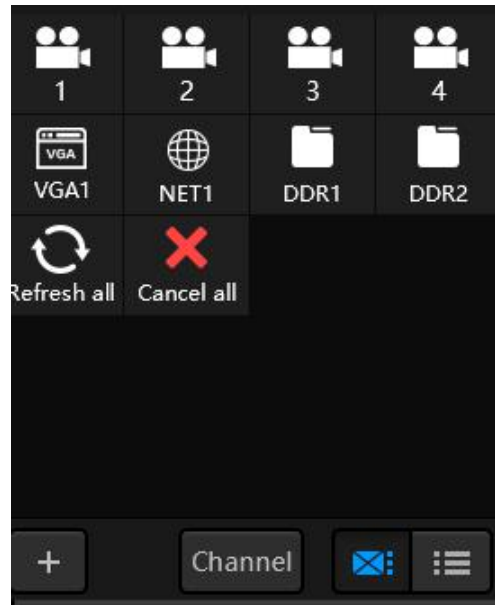

Select the [Channel] button and select the channel in the list to directly put the selected CG on the corresponding channel. It can be used to display different advertisements, subtitles when switching channels.

5.3.4 CG Element



- 1) Text
- 2) Picture/GIF/sequence picture
- 3) Channel
- 4) Clock/Timer
- 5) Graphics
- 6) Dynamic data
- 7) Suitable for size
- 8) Preview
- 9) Show/hide safety box
- 10) Alignment
- 11) Add row to table
- 12) Add column to table

CG elements include text, pictures, picture sequences, clock, timer, custom pictures, and dynamic data. It is described as follow:

1. Text

Click the text button in the CG element selection area to create a new text element in the workspace. Click the icon on the text to set the parameters, as shown in the figure below:

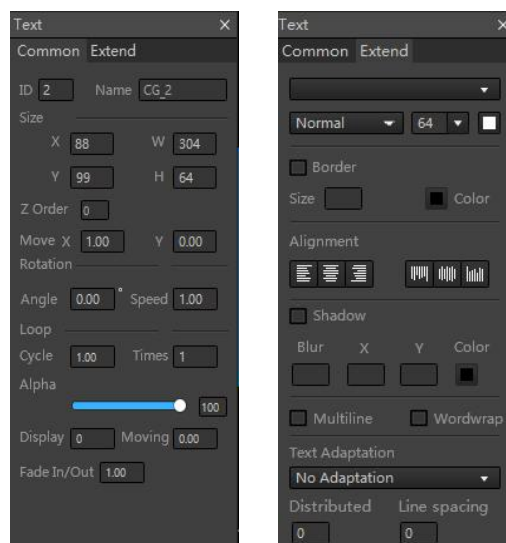

- Basic Parameters

Move X and Y represent pixels moving in the X or Y direction every second. Negative numbers indicate moving to the left and positive numbers indicate moving to the right. The larger the value, the faster the movement speed. Combining display duration, moving duration, loop cycle and number of loops can achieve a marquee effect.

Set "Angle" and "Speed" in the rotation parameters to rotate at a certain speed and angle.

The unit of the loop cycle is second. For example, if the cycle is set to 3 and the number of times is 3, it means that 3 seconds is a movement cycle and a total of 3 cycles are performed. Cycle is set to 0 or Number of times is set to 0 or 1 to indicate that no loop operation is performed.

The "Z-Order" parameter is similar to the cascade concept, and can set the cascade effect of multiple elements. A larger value corresponds to the bottom layer, and a smaller value corresponds to the upper layer. The "Alpha" parameter refers to the degree of light transmission, which can affect its effect of overlapping with another element.

"Moving" refers to the length of moving. "Display" refers to the length of time displayed during the moving duration, and "fade in/out" refers to the effect of the element when it is displayed and disappears, and the unit is second. If the moving duration is set to 10 seconds and displayed as 3 seconds, it means that elements can be displayed in the first three seconds, and no elements are displayed in the next two seconds.

- Extend Parameter

You can set font style, size, bold, italics, alignment, text colour, border colour, border size and border transparency. Among them, "Multiline" means that the font is converted into multiple lines in the frame, and "Wordwrap" means that a line of text is longer than the length of the frame, and a line of text is truncated to two lines of text.

2. Picture (Sequence Picture/GIF)

Click the picture button in the CG element selection area, and a dialog box for selecting a picture file will pop up. After selecting the corresponding picture, the picture element will be added to the work area. Pictures support BMP/JPG/JPEG and PNG formats. Click the  icon on the picture to set its parameters, as shown below:

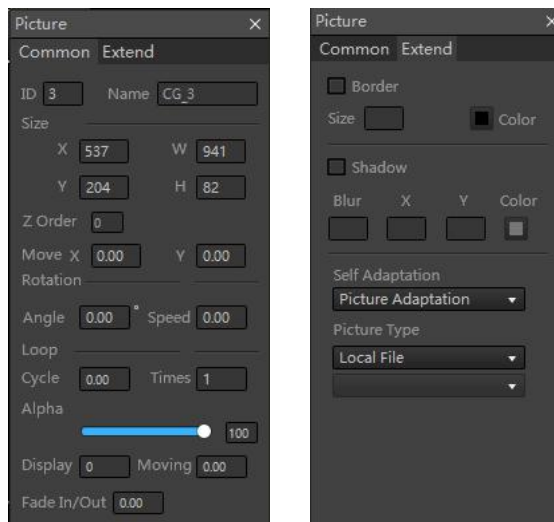

Basic parameters: Please refer to "Text - Basic Parameters" description.

Extend parameters: You can activate the border settings, including its size and colour. You can also activate the shadow settings, including blur values, x and y direction shadows and shadow colours. Last, select picture adaptation and picture type.

3. Clock / Timer

Click the clock/timer button in the CG element selection area to add into the workspace. Click the  icon on timer or clock to set its parameters, as shown below:

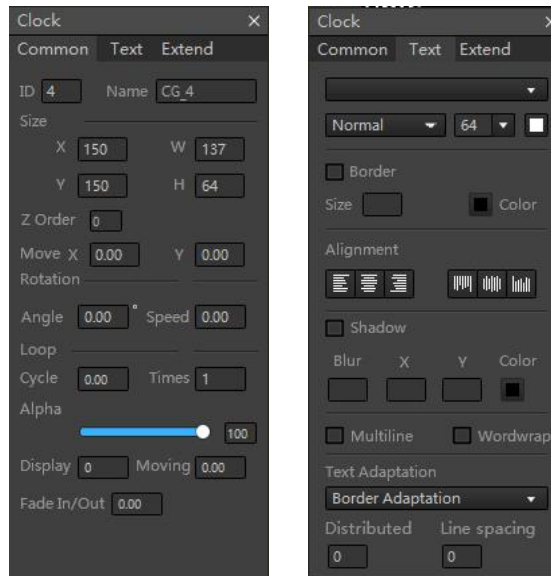

Basic parameters: Please refer to "Text - Basic Parameters" description.

Text parameters: You can set font style, size, bold, italics, text alignment, text colour, border colour, border size, border transparency and fade time. Among them, "Multiline" means that the font is converted into multiple lines in the frame, and "Wordwrap" means that the length of a line of text exceeds the length of the frame, and a line of text is truncated into two lines of text.

Extend parameters: Clock and timer extend parameters are shown below:

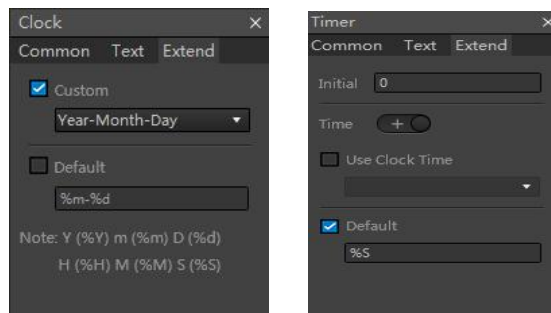

The clock extension parameters can be set to display the format or customized. Customization should follow the format of the prompt. The timer extension parameter can select the clock format, and can set the initial value to be timed according to addition or subtraction.

4. Channel

It can be used to display the content of another channel to achieve the effect which similar to picture-in-picture. Click the  icon on the channel to set its parameters, as shown in the figure below:

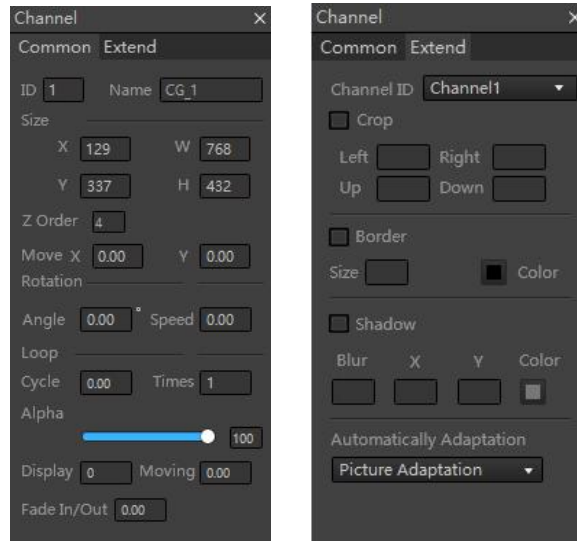



Basic parameters: Please refer to "Text - Basic Parameters" description.

Extend parameters: First, select the channel to be loaded, crop the channel data after loading, set the border and shadow parameters, and select the picture to adapt.

5. Graphics

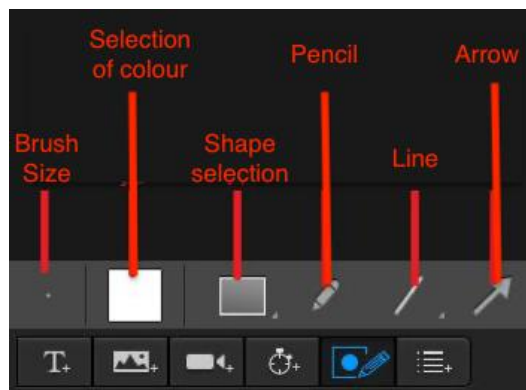
You can customize the graphics, as shown below:



Click the  icon to set its parameters, as shown below:

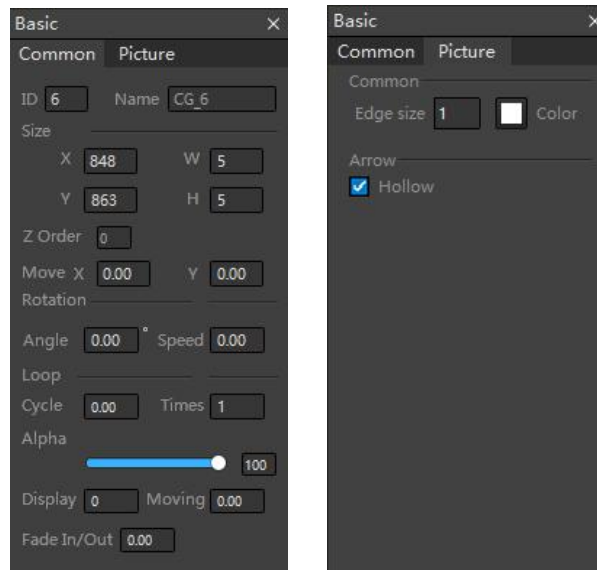

Basic parameters: Please refer to "Text - Basic Parameters" description.

Extend parameters: Edge size and colour can be set, and rectangle fillet size can be set.

6. Dynamic Data

After importing the EXCEL table, or loading an RSS, or adding rows and columns, you can select text and picture columns in the dynamic data to set them.

5.3.5 System Settings



1. Device Connection: Refer to the description of “Remote Publishing” chapter.
2. CG project naming: Custom project name.
3. Settings: Contains project format settings, shortcut key settings, and copyright information, as shown in the following figure:

