

ENGLISH

Infinity TCYC-7 Cyclorama

V1

**Ordercode: 200300
Firmware Version 1.04**

Table of contents

Warning	3
Safety Instructions	4
Operating Determinations	5
Rigging	5
Bracket Installation	6
Clamp Installation.....	7
Connection with the mains.....	7
Return Procedure.....	8
Claims.....	8
Description of the device	9
Overview	10
Back.....	10
Focus Angle	11
Installation	11
Set Up and Operation	11
Using the Barndoor	12
Control Modes.....	13
One Cyclorama (Manual control)	13
Multiple Cycloramas (DMX Control)	13
Fixture Linking.....	14
Data Cabling.....	14
Control Panel.....	15
Control Mode	15
DMX Addressing.....	15
Menu Overview.....	16
Activate Focus Mode	18
Main Menu Options.....	18
1. DMX Configuration.....	19
2. DMX Address	19
3. Manual.....	19
3.1 Dimmer	19
3.2 Color Temperature	19
3.3 Color Wheel.....	20
3.4 Tilt Position	20
4. Dimmer Curves.....	21
5. Dimmer Speed	21
6. CCT Mode.....	22
7. Tungsten Simulation.....	22
8. DMX Lost Mode	23
9. Fan Mode.....	23
10. PWM Frequency.....	23
11. Calibration	23
12. Display	24
13. Tilt Motor	24
13.1 Tilt Motor Reset	24
13.2 Tilt Motor Encoder.....	24
13.3 Tilt Motor On/OFF.....	24
14. Info.....	25
15. Reset Factory Settings.....	25
DMX Channels Quickguide	26
DMX Channels	27
1 Channel (Basic).....	27
6 Channels (Basic)	27
7 Channels (Thungsten)	29

11 Channels (RGB Pro Mode)31
11 Channels (CMY Pro Mode)34
11 Channels (HSI Pro Mode)37
21 Channels (RAW Mode)40

Maintenance44

Troubleshooting44
 No Light44
 No Response to DMX.....44

Product Specifications46

Dimensions.....47

Notes48

Warning



**For your own safety, please read this user manual carefully
before your initial start-up!**



Unpacking Instructions

Immediately upon receiving this product, carefully unpack the carton and check the contents to ensure that all parts are present, and have been received in good condition. Notify the dealer immediately and retain packing material for inspection if any parts appear damaged from shipping or the carton itself shows signs of mishandling. Save the carton and all packing materials. In the event that a fixture must be returned to the factory, it is important that the fixture be returned in the original factory box and packing.

Your shipment includes:

- Infinity TCYC-7 Cyclorama
- Neutrik PowerCON to Schuko power cable (1,4 m)
- Safety cable
- 2x brackets
- User manual

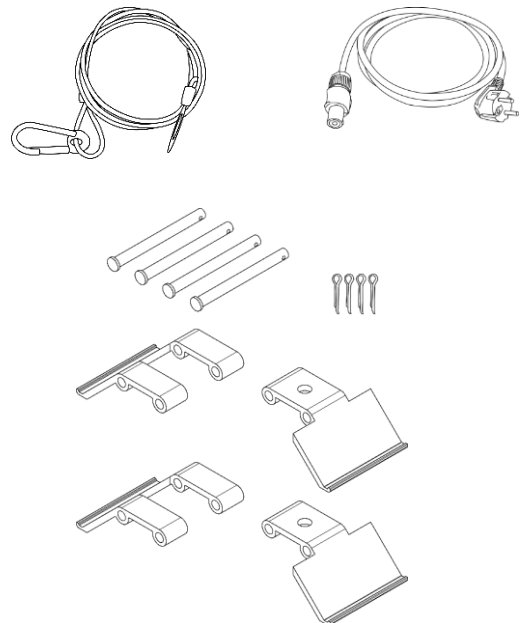
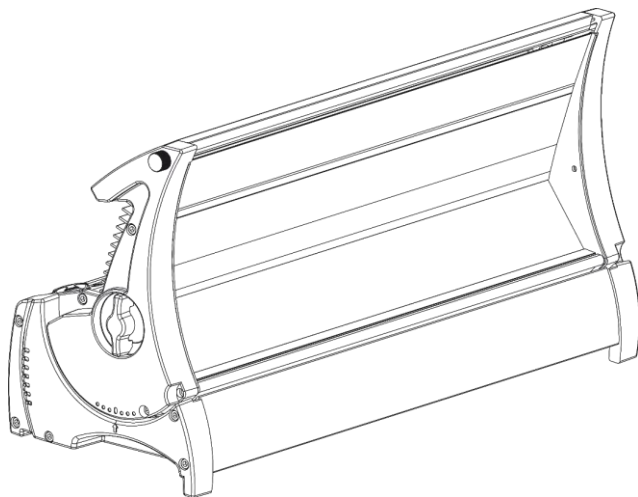

LED Expected Lifespan

LEDs gradually decline in brightness over time. HEAT is the dominant factor that leads to the acceleration of this decline. Packaged in clusters, LEDs exhibit higher operating temperatures than in ideal or singular optimum conditions. For this reason when all color LEDs are used at their fullest intensity, life of the LEDs is significantly reduced. If improving your lifespan expectancy is of a higher priority, place care in providing for lower operational temperatures. This may include climatic-environmental and the reduction of overall projection intensity.



CAUTION!
Keep this device away from rain and moisture!
Unplug mains lead before opening the housing!



Safety Instructions

Every person involved with the installation, operation and maintenance of this device has to:

- be qualified
- follow the instructions of this manual

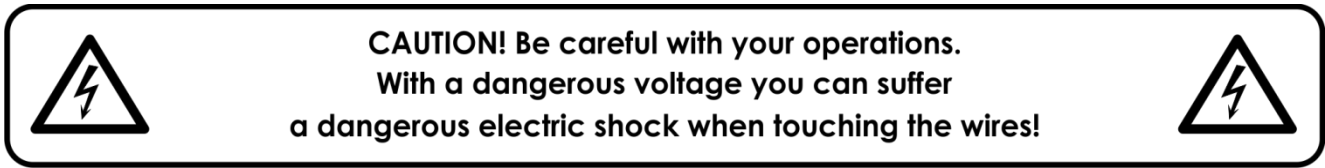

Before your initial start-up, please make sure that there is no damage caused by transportation. Should there be any, consult your dealer and do not use the device.

To maintain perfect condition and to ensure a safe operation, it is absolutely necessary for the user to follow the safety instructions and warning notes written in this manual.

Please consider that damages caused by manual modifications to the device are not subject to warranty.

This device contains no user-serviceable parts. Refer servicing to qualified technicians only.

IMPORTANT:

The manufacturer will not accept liability for any resulting damages caused by the non-observance of this manual or any unauthorized modification to the device.

- Never let the power cord come into contact with other cables! Handle the power cord and all connections with the mains with particular caution!
- Never modify, bend, mechanically strain, put pressure on, pull or heat up the power cord.
- Never strain the cable insert or the female part in the device. There must always be sufficient cable going to the device. Otherwise, the cable will be damaged, which can cause serious damage.
- Never remove warning or informative labels from the unit.
- Never use anything to cover the ground contact.
- Never lift the device holding it by the projector-head, as the mechanics may be damaged. Always hold the device by the transport handles.
- Never place any material over the lens.
- Never look directly into the light source.
- Never leave any cables lying around.
- Never use the device during thunderstorms, unplug the device immediately.
- Never leave various parts of the packaging (plastic bags, polystyrene foam, nails, etc.) within children's reach, as they are potential sources of danger.
- Do not insert objects into air vents.
- Do not open the device and do not modify the device.
- Do not connect this device to a dimmer pack.
- Do not switch the device on and off in short intervals, as this will reduce the device's life.
- Do not touch the device's housing bare-handed during its operation (housing becomes hot). Allow the device to cool for at least 5 minutes before handling.
- Do not shake the device. Avoid brute force when installing or operating the device.
- Only use the device indoors, avoid contact with water or other liquids.
- Only operate the device after having checked if the housing is firmly closed and all screws are tightly fastened.
- Only operate the device after having familiarized with its functions.
- Avoid flames and do not put close to flammable liquids or gases.
- Always keep the case closed while operating.
- Always allow a free air space of at least 50 cm around the unit for ventilation.
- Always disconnect power from the mains, when device is not used or before cleaning! Only handle the power cord holding it by the plug. Never pull out the plug by tugging the power cord.
- Make sure that the device is not exposed to extreme heat, moisture or dust.
- Make sure that the available voltage is not higher than stated on the rear panel.
- Make sure that the power cord is never crimped or damaged. Check the device and the power cord from time to time.

- Make sure that the core diameter of extension cords and power cords is sufficient for the required power consumption of the device.
- If the lens is obviously damaged, it has to be replaced to prevent its functions from being impaired, due to cracks or deep scratches.
- If the external cable is damaged, it has to be replaced by a qualified technician.
- If device was dropped or struck, disconnect mains power supply immediately. Have a qualified engineer inspect for safety before operating.
- If the device has been exposed to drastic temperature fluctuation (e.g. after transportation), do not switch it on immediately. The arising condensation water might damage your device. Leave the device switched off until it has reached room temperature.
- If your device fails to work properly, discontinue the use immediately. Pack the unit securely (preferably in the original packing material), and return it to your Infinity dealer for service.
- For adult use only. The device must be installed beyond the reach of children. Never leave the unit running unattended.
- Never attempt to bypass the thermostatic switch or fuses.
- For replacement use fuses of same type and rating only.
- The user is responsible for correct positioning and operating of the device. The manufacturer will not accept liability for damages caused by the misuse or incorrect installation of this device.
- This device falls under protection class I. Therefore it is essential to connect the yellow/green conductor to earth.
- Repairs, servicing and electric connection must be carried out by a qualified technician.
- WARRANTY: Till one year after date of purchase.

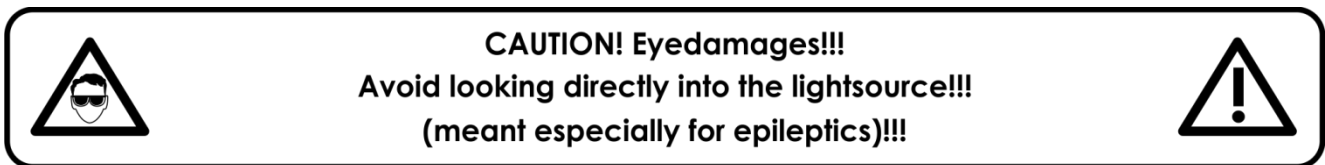

Operating Determinations

- This device is not designed for permanent operation. Consistent operation breaks will ensure that the device will serve you for a long time without defects.
- The minimum distance between light output and the illuminated surface must be bigger than 1 meter.
- In order to eliminate wear and improve the device's lifespan, during periods of non-use, completely disconnect from power source via breaker or by unplugging.
- The maximum ambient temperature $t_a = 40^\circ\text{C}$ must never be exceeded.
- The relative humidity must not exceed 50 % with an ambient temperature of 40°C .
- If this device is operated in any other way than the one described in this manual, the product may suffer damages and the warranty becomes void.
- Any other operation may lead to dangers like short-circuit, burns, electric shock, crash, etc.

You endanger your own safety and the safety of others!

Rigging

Please follow the European and national guidelines concerning rigging, trussing and all other safety issues.

Do not attempt the installation yourself !

Always let the installation be carried out by an authorized dealer !

Procedure:

- If the device is lowered from the ceiling or high joists, professional trussing systems have to be used.
- Use a clamp to mount the device, with the mounting-bracket, to the trussing system.
- The device must never be fixed swinging freely in the room.
- The installation must always be secured with a safety attachment, e.g. an appropriate safety net or safety-cable.
- When rigging, derigging or servicing the device, always make sure, that the area below the installation place is blocked and staying in the area is forbidden.

Bracket Installation

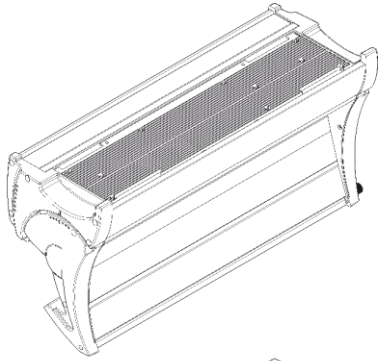

01) Carefully place the Cyclorama on its side.

1x

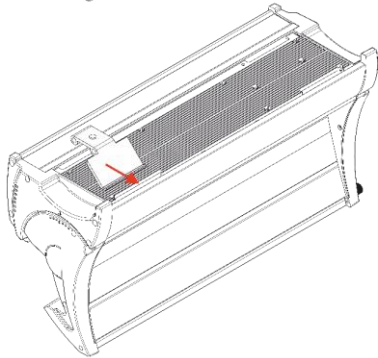

02) Slide the lip of the clamp under the designated area.

1x

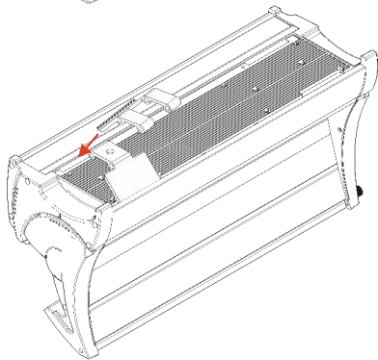

03) Slide the lip of the other clamp under the designated area.

2x

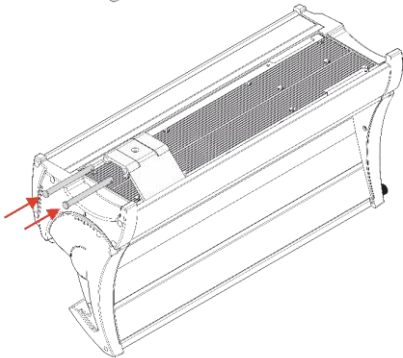

04) Align both parts, so that both pins can slide into the holes.

2x

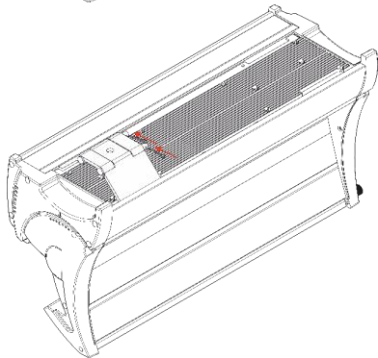

05) For extra safety, you have to install the split pins in the tiny holes.

Clamp Installation

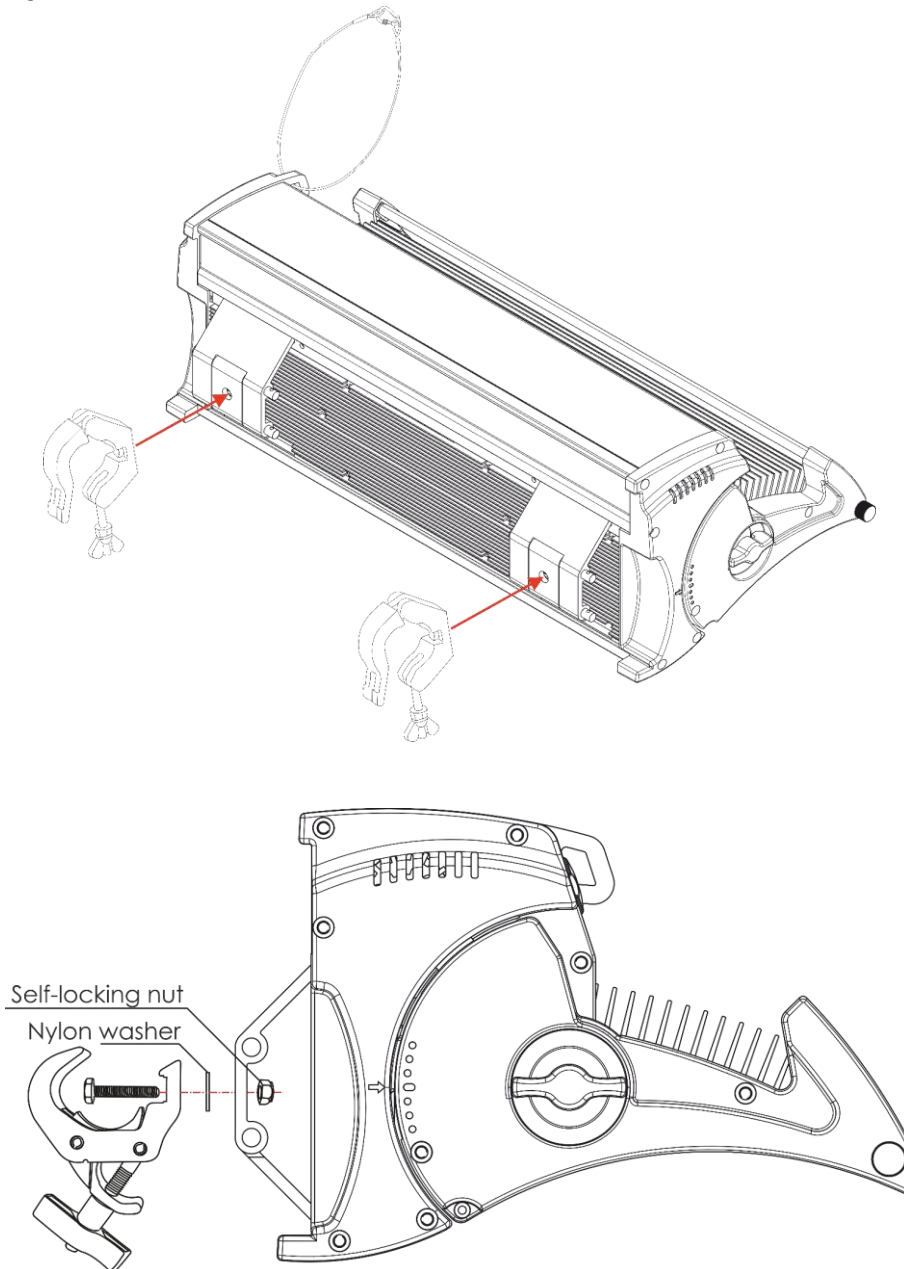

The Infinity TCYC-7 Cyclorama can be placed on a flat stage floor or mounted to any kind of truss with a clamp.

Improper installation can cause serious injuries and/or damage of property !

Connection with the mains

Connect the device to the mains with the power-plug.

Always pay attention, that the right color cable is connected to the right place.

International	EU Cable	UK Cable	US Cable	Pin
L	BROWN	RED	YELLOW/COPPER	FASE
N	BLUE	BLACK	SILVER	NULL
⊕	YELLOW/GREEN	GREEN	GREEN	EARTH

Make sure that the device is always connected properly to the earth!

Improper installation can cause serious injuries and/or damage of property !



Return Procedure

Returned merchandise must be sent prepaid and in the original packing, call tags will not be issued. Package must be clearly labeled with a Return Authorization Number (RMA number). Products returned without an RMA number will be refused. Highlite will not accept the returned goods or any responsibility. Call Highlite 0031-455667723 or mail aftersales@highlite.com and request an RMA prior to shipping the fixture. Be prepared to provide the model number, serial number and a brief description of the cause of the return. Be sure to properly pack fixture as any shipping damage resulting from inadequate packaging is the customer's responsibility. Highlite reserves the right to use its own discretion to repair or replace product(s). As a suggestion, proper UPS packing or double-boxing is always a safe method to use.

Note: If you are given an RMA number, please include the following information on a piece of paper inside the box:

- 01) Your name.
- 02) Your address.
- 03) Your phone number.
- 04) A brief description of the symptoms.

Claims

The client has the obligation to check the delivered goods immediately upon delivery for any shortcomings and/or visible defects, or perform this check after our announcement that the goods are at their disposal. Damage incurred in shipping is the responsibility of the shipper; therefore the damage must be reported to the carrier upon receipt of merchandise.

It is the customer's responsibility to notify and submit claims with the shipper in the event that the fixture is damaged due to shipping. Transportation damage has to be reported to us within one day after receipt of the delivery.

Any return shipment has to be made post-paid at all times. Return shipments must be accompanied with a letter defining the reason for return shipment. Non-prepaid return shipments will be refused, unless agreed otherwise in writing.

Complaints against us must be made known in writing or by fax within 10 working days after receipt of the invoice. After this period, complaints will not be handled anymore.

Complaints will only be considered if the client has so far complied with all parts of the agreement, regardless of the agreement of which the obligation is resulting.

Description of the device

Features

The Infinity TCYC-7 Cyclorama is an extremely bright and powerful luminaire.

- 300W Lumiled 7 colour LED engine using custom designed array
- CRI > 96 Consistently on full CCT range
- LED Colour Linearity Compensation
- LED Colour Temperature Drift Compensation (on all LEDs)
- Optics Colour Shift compensation
- Colour wheel with 64 spectrum matching Filter gels
- 2000 – 8000K Seamless CCT channel
- RGB, CMY and HSI Colour control
- 16 bit Intelligent high resolution virtual dimming
- Tungsten mode with natural colour drift & timing simulations
- Flicker-Free with selectable PWM by DMX
- RDM allowing for remote setting and recall of information
- Motorized 30° focusing
- 1CH DMX mode for conventional replacement
- Light output: 6000lm
- Light quality: >96 CRI Consistently (High CRI Mode)
- Colour Temperature: 2000K ~ 8000K
- Beam Angle: asymmetric 75°
- Tilt adjustment: 30° manual and motorized
- Input voltage: 100-240V AC, 50/60Hz
- Power Factor: 0,96
- Consumption: 310W max
- Dimmer: 0-100%
- Strobe: 0-20Hz
- Ambient temperature: 0°-40°C (operating)
- Startup temperature: -10°-45°C
- LC-display for easy setup
- DMX-control: via standard DMX/RDM controller
- Control: DMX-512, Manual control
-
- IP Rating: IP 20, indoor use only
- Control: On board Menu, RDM, DMX512
- Fan mode: Silent, Auto, Full
- DMX Channels: Dimmer Mode, 1CH
Basic Mode, 6CH
Tungsten Mode, 7CH
HSI Pro Mode, 11CH
RGB Pro Mode, 11CH
CMY Pro Mode, 11CH
RAW Mode, 21CH
- Power connections: Neutrik PowerCON (IN/OUT)
- Data connections: Neutrik 5-pin XLR data (IN/OUT)
- Construction: Machined Aluminium, sheet metal, moulded engineering grade plastics.
- Colour: Black
- Dimensions: 566 x 195 x 257 mm (LxWxH) excl. bracket
- Weight: 11,2Kg

Note: Knowledge of DMX is required to fully utilize this unit.

Overview

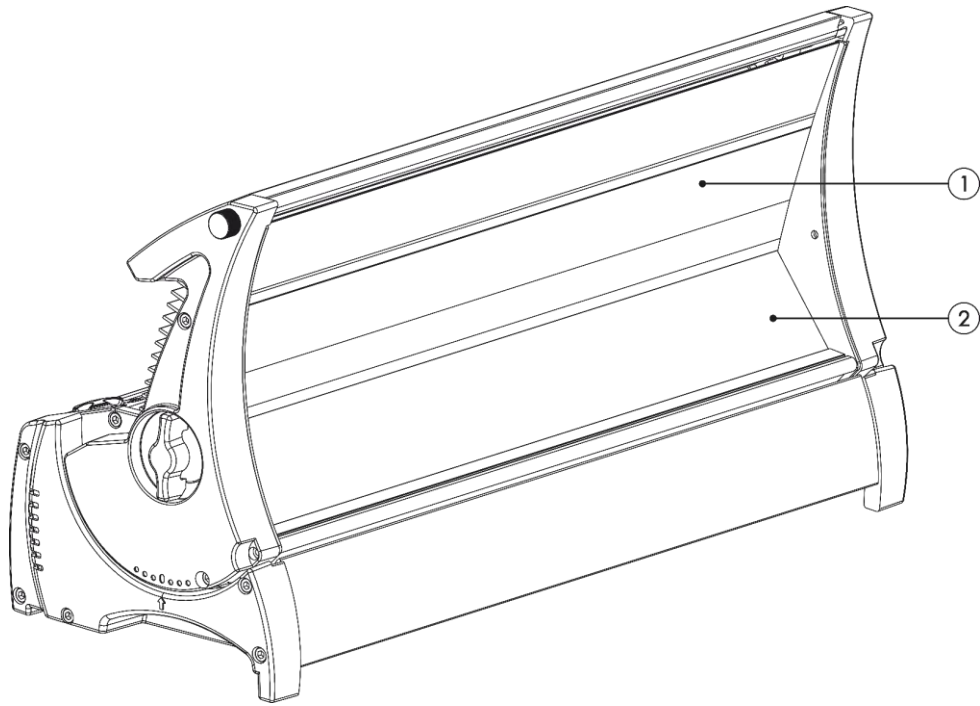

Fig. 01

- 01) Mirror
- 02) 300W Lumiled 7-color LED

Back

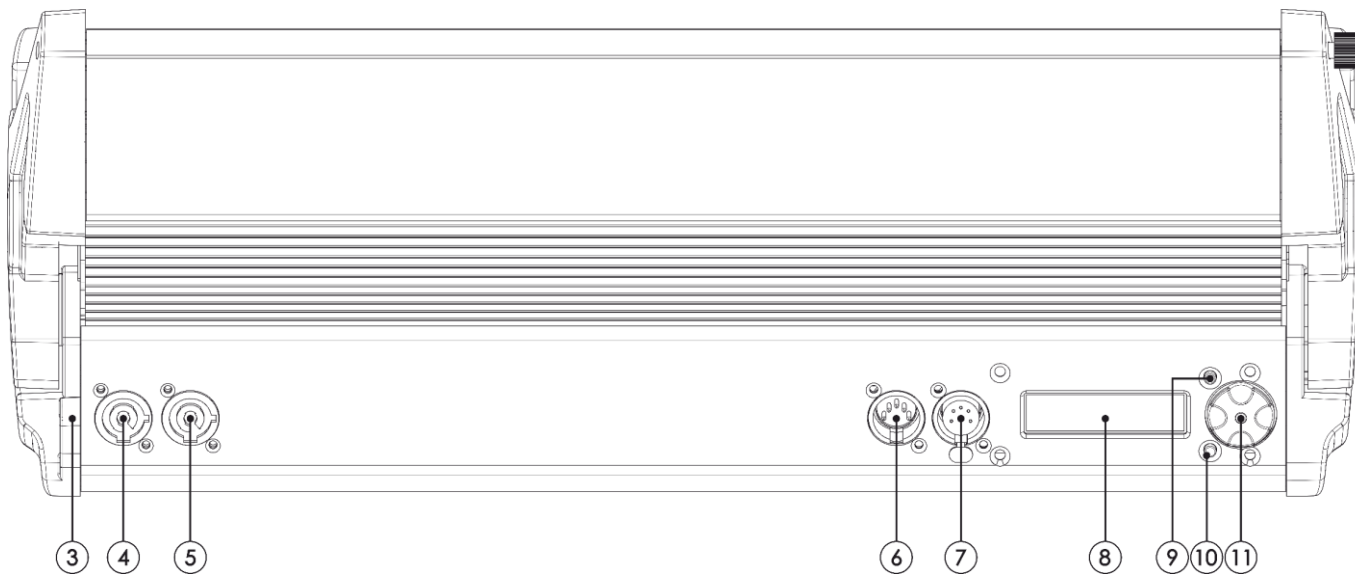
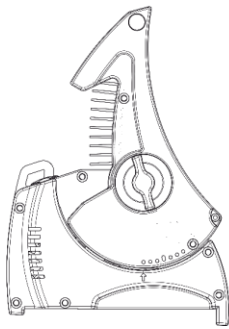
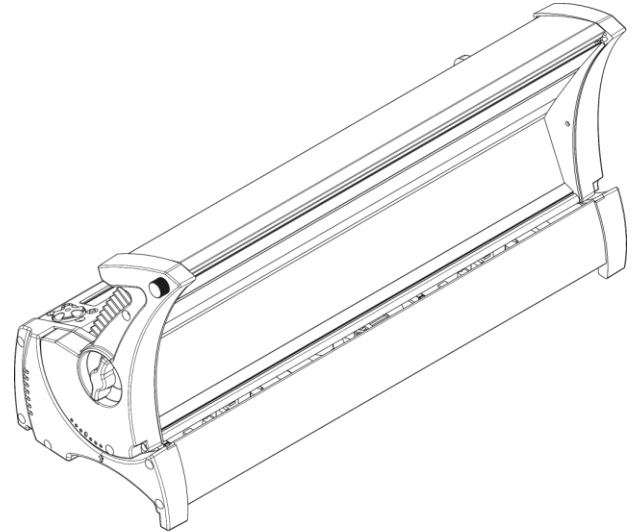
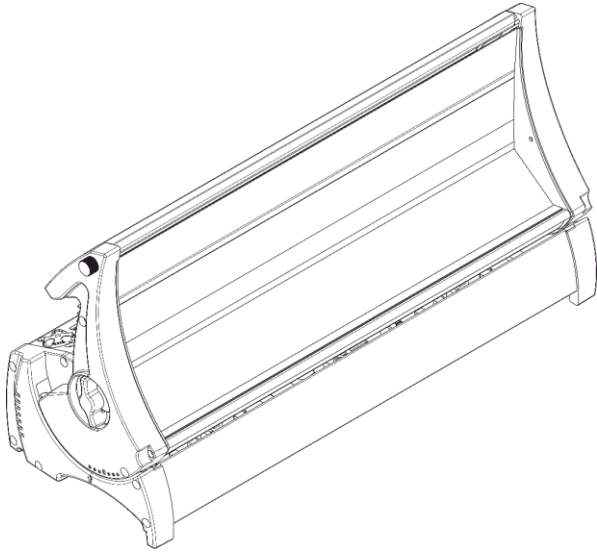

Fig. 02

- 03) Safety Eye
- 04) Neutrik PowerCON OUT (Gray)
- 05) Neutrik PowerCON IN (Blue)
- 06) 5-pin DMX signal connector IN
- 07) 5-pin DMX signal connector OUT
- 08) LCD Display
- 09) Back/Home Button (hold down >3sec = focus mode)
- 10) Menu Button
- 11) Control wheel / Enter

Focus Angle



Focus angle 0°-Electronic adjustment

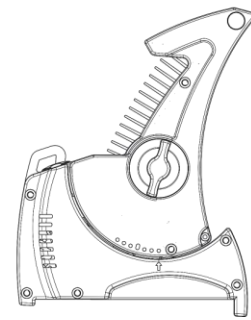

Focus angle 30°- Electronic adjustment

Fig. 03

Installation

Remove all packing materials from the Infinity TCYC-7. Check that all foam and plastic padding is removed. Connect all cables.

Do not supply power before the whole system is set up and connected properly.

Always disconnect from electric mains power supply before cleaning or servicing.

Damages caused by non-observance are not subject to warranty.

Set Up and Operation

Follow the directions below, as they pertain to your preferred operation mode.

Before plugging the unit in, always make sure that the power supply matches the product specification voltage. Do not attempt to operate a 120V specification product on 230V power, or vice versa.

Using the Barndoor

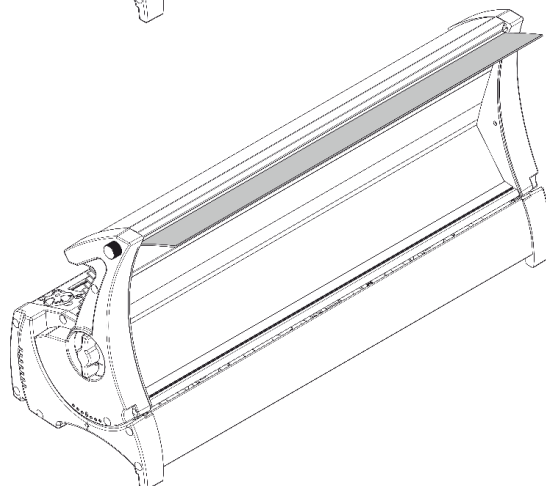
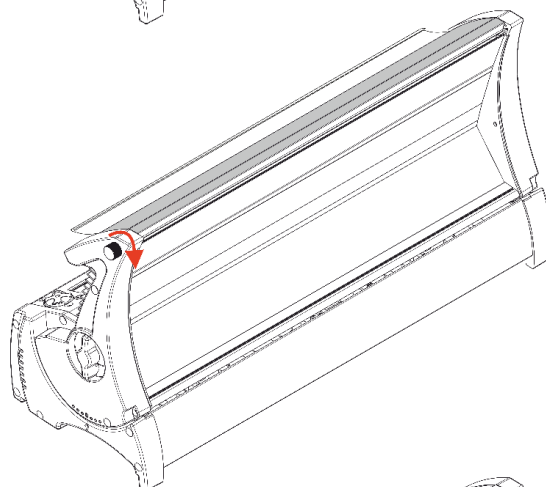
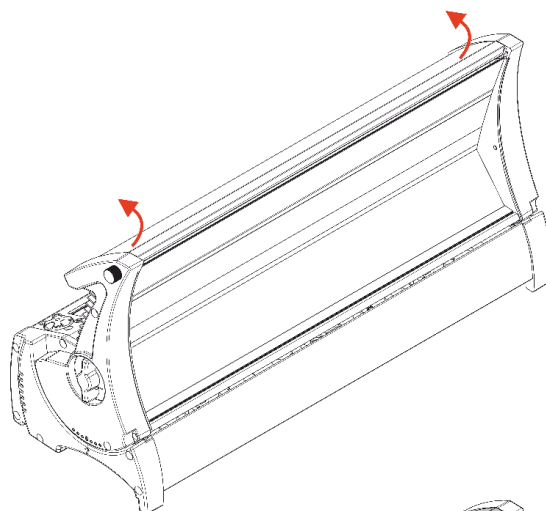
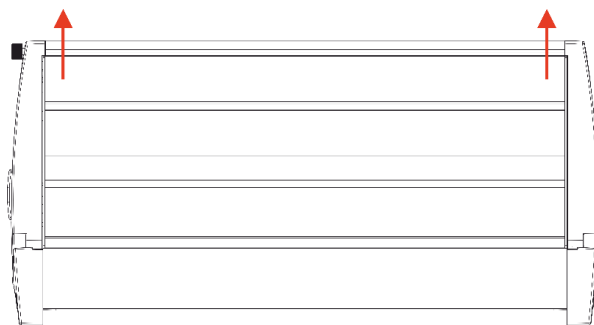

Control Modes

There are 2 modes:

- Manual control
- DMX512 (1CH, 6CH, 7CH, 11CH, 11CH, 11CH or 21CH)

One Cyclorama (Manual control)

- 06) Fasten the effect light onto firm trussing. Leave at least 0,5 meter on all sides for air circulation.
- 07) Always use a safety cable (ordercode 70140 / 70141).
- 08) Plug the end of the electric mains power cord into a proper electric power supply socket.
- 09) When the Cyclorama is not connected with a DMX cable, it functions as a stand-alone device.
- 10) Please see pages 19 and 20 for more information about the Manual control mode.

Multiple Cycloramas (DMX Control)

- 01) Fasten the effect light onto firm trussing. Leave at least 0,5 meter on all sides for air circulation.
- 02) Always use a safety cable (ordercode 70140 / 70141).
- 03) Plug the end of the electric mains power cord into a proper electric power supply socket.
- 04) Use a 3-pin/5-pin XLR cable to connect the Cycloramas and other devices.

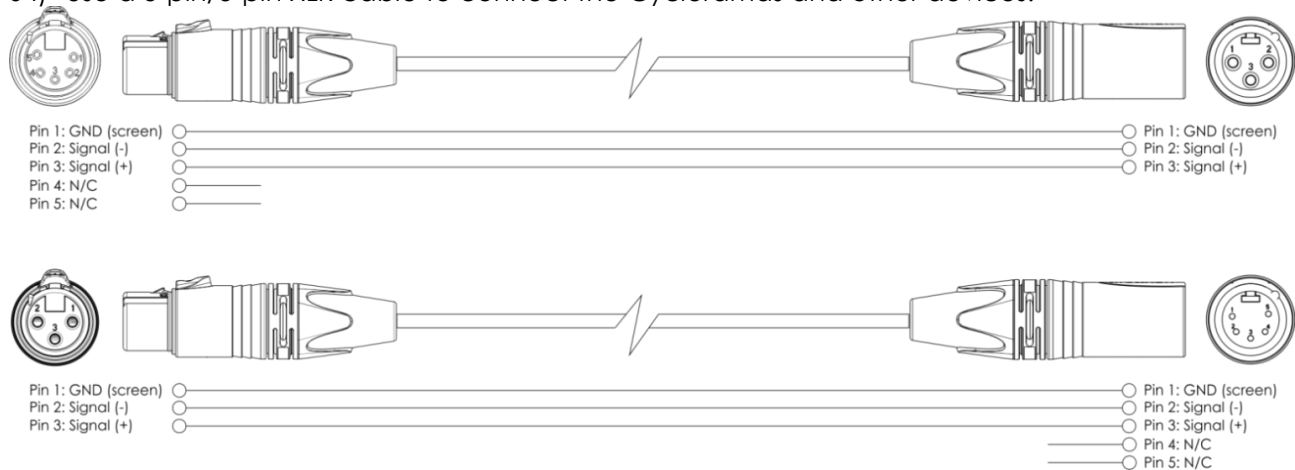

- 05) Link the units as shown in fig. 12. Connect a DMX signal cable from the first unit's DMX "out" socket to the second unit's "in" socket. Repeat this process to link the second, third, and fourth units.
- 06) Supply electric power: Plug electric mains power cords into each unit's PowerCON socket, then plug the other end of the mains power cord into proper electric power supply sockets, starting with the first unit. Do not supply power before the whole system is set up and connected properly.

Multiple Cycloramas DMX Set Up

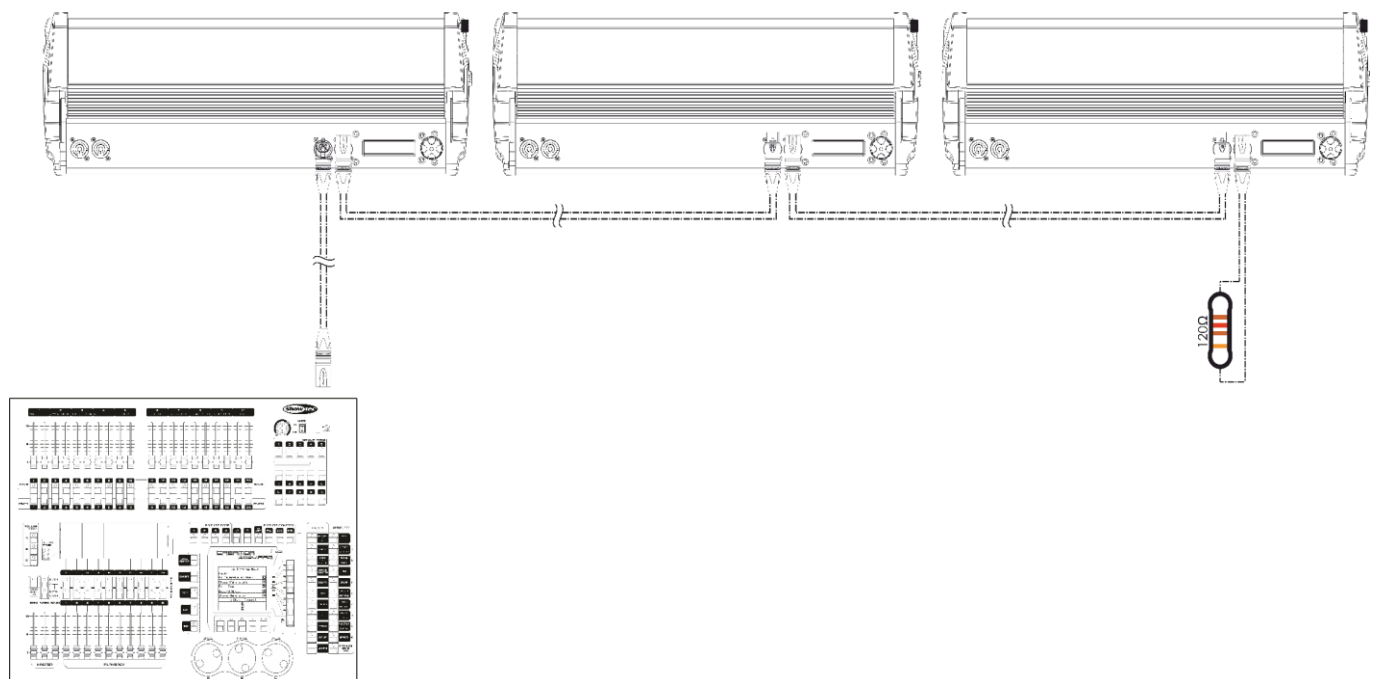

Fig. 12

Note: Link all cables before connecting electric power

Fixture Linking

You will need a serial data link to run light shows of one or more fixtures using a DMX-512 controller or to run synchronized shows on two or more fixtures set to a master/slave operating mode. The combined number of channels required by all the fixtures on a serial data link determines the number of fixtures the data link can support.

Important: Fixtures on a serial data link must be daisy chained in one single line. To comply with the EIA-485 standard no more than 30 devices should be connected on one data link. Connecting more than 30 fixtures on one serial data link without the use of a DMX optically isolated splitter may result in deterioration of the digital DMX signal.



Maximum recommended DMX data link distance: 100 meters

Maximum recommended number of fixtures on a DMX data link: 30 fixtures

Maximum recommended number of fixtures on a power link @120V: 4 fixtures

Maximum recommended number of fixtures on a power link @230V: 8 fixtures

Data Cabling

To link fixtures together you must obtain data cables. You can purchase DAP Audio certified DMX cables directly from a dealer/distributor or construct your own cable. If you choose to create your own cable please use data-grade cables that can carry a high quality signal and are less prone to electromagnetic interference.

DMX Data Cables

- DAP 110 Ohm cable with digital signal transmission. **Ordercode** FL0975 (0,75 m), FL09150 (1,5 m), FL093 (3 m), FL096 (6 m), FL0910 (10 m), FL0915 (15 m), FL0920 (20 m).
- DAP data cable FL08 DMX/AES-EBU, XLR/M 5-pin > XLR/F 5-pin. **Ordercode** FL08150 (1,5 m), FL083 (3 m), FL086 (6 m), FL0810 (10 m), FL0820 (20 m).
- DAP DMX adapter: 5-pin > 3-pin. **Ordercode** FLA29.
- DAP DMX adapter: 3-pin > 5-pin. **Ordercode** FLA30.
- DAP DMX Terminator 3-pin. **Ordercode** FLA42.
- DAP DMX Terminator 5-pin. **Ordercode** FLA43.

The Infinity TCYC-7 Cyclorama can be operated with a controller in **control mode** or without the controller in **stand-alone mode**.

Control Panel

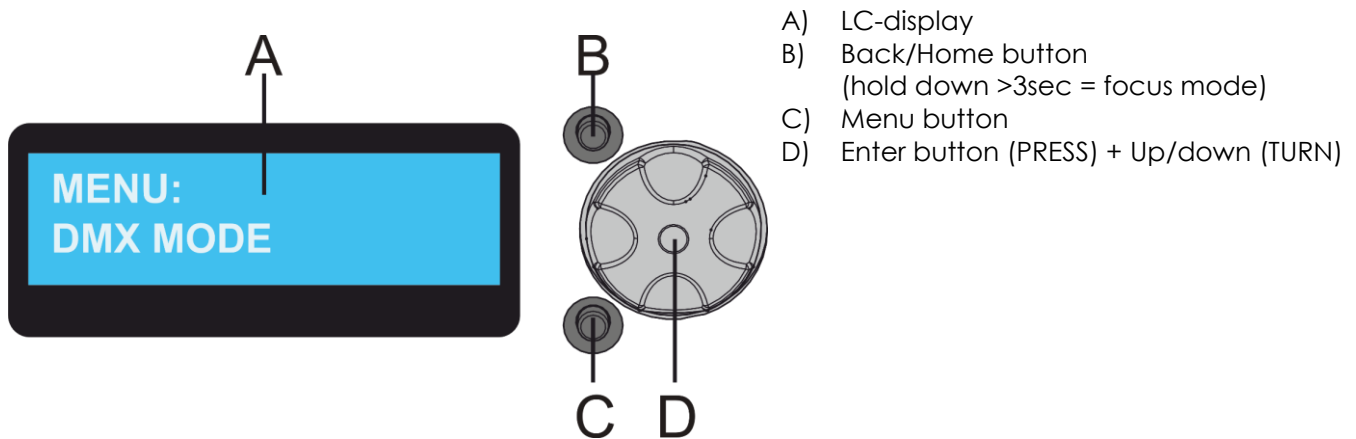

Fig. 13

Control Mode

The fixtures are individually addressed on a data-link and connected to the controller. The fixtures respond to the DMX signal from the controller. (When you select the DMX address and save it, the controller will display the saved DMX address the next time.)

DMX Addressing

The control panel on the front side of the base allows you to assign the DMX fixture address, which is the first channel from which the Cyclorama will respond to the controller.

Please note when you use the controller, the unit has **21** channels.

When using multiple Cycloramas, make sure you set the DMX addresses right.

Therefore, the DMX address of the first Cyclorama should be **1(001)**; the DMX address of the second Cyclorama should be **1+21=22 (022)**; the DMX address of the third Cyclorama should be **22+21=43 (043)**, etc.

Please, be sure that you do not have any overlapping channels in order to control each Cyclorama correctly. If two or more Cycloramas are addressed similarly, they will work similarly.

Controlling:

After having addressed all Cyclorama fixtures, you may now start operating these via your lighting controller.

Note: After switching on, the Cyclorama will automatically detect whether DMX 512 data is received or not. If not the problem may be:

- The XLR cable from the controller is not connected with the input of the Cyclorama.
- The controller is switched off or defective, the cable or connector is defective, or the signal wires are swapped in the input connector.

Note: It's necessary to insert a XLR termination plug (with 120 Ohm) in the last fixture in order to ensure proper transmission on the DMX data link.

Menu Overview

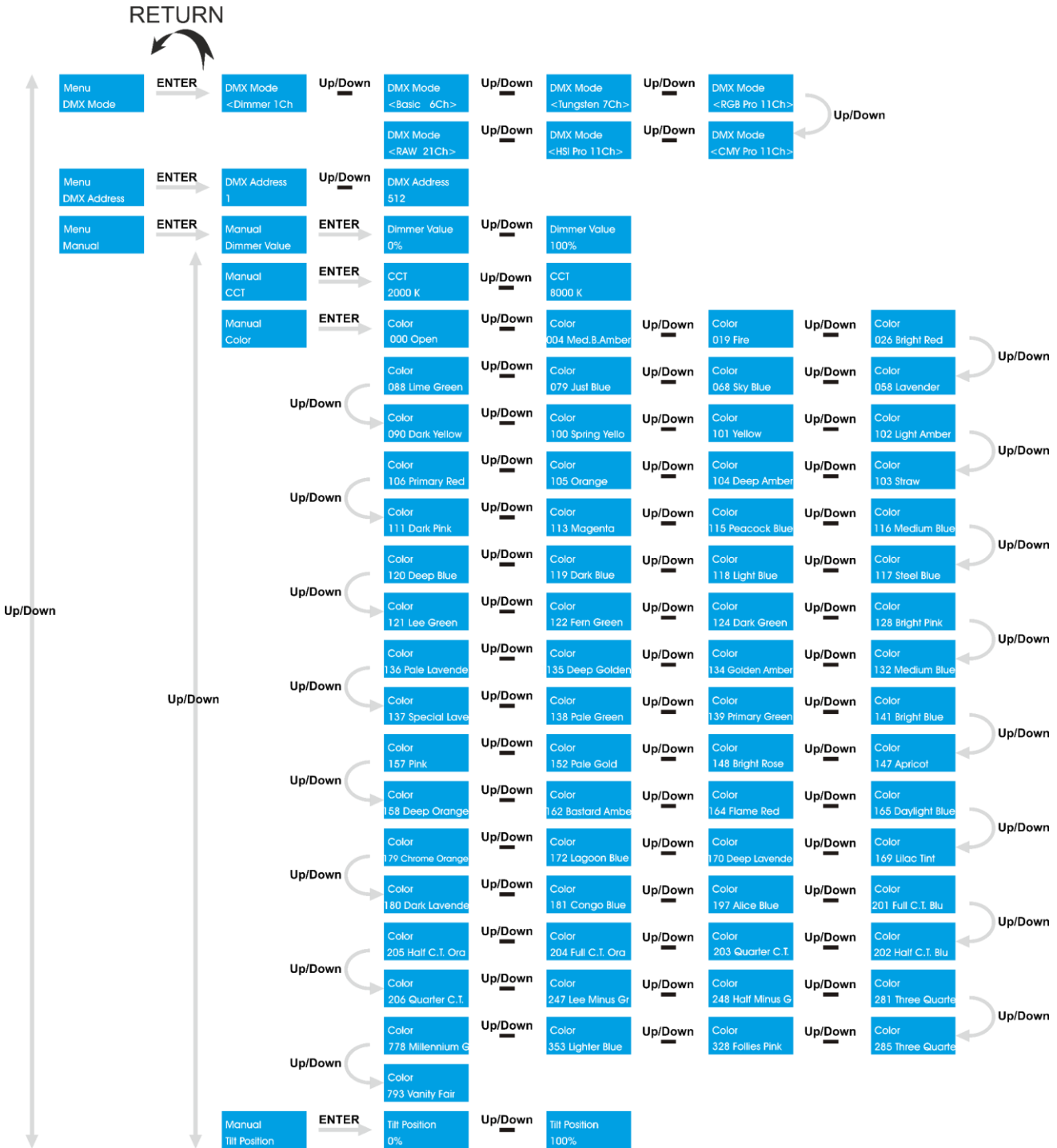

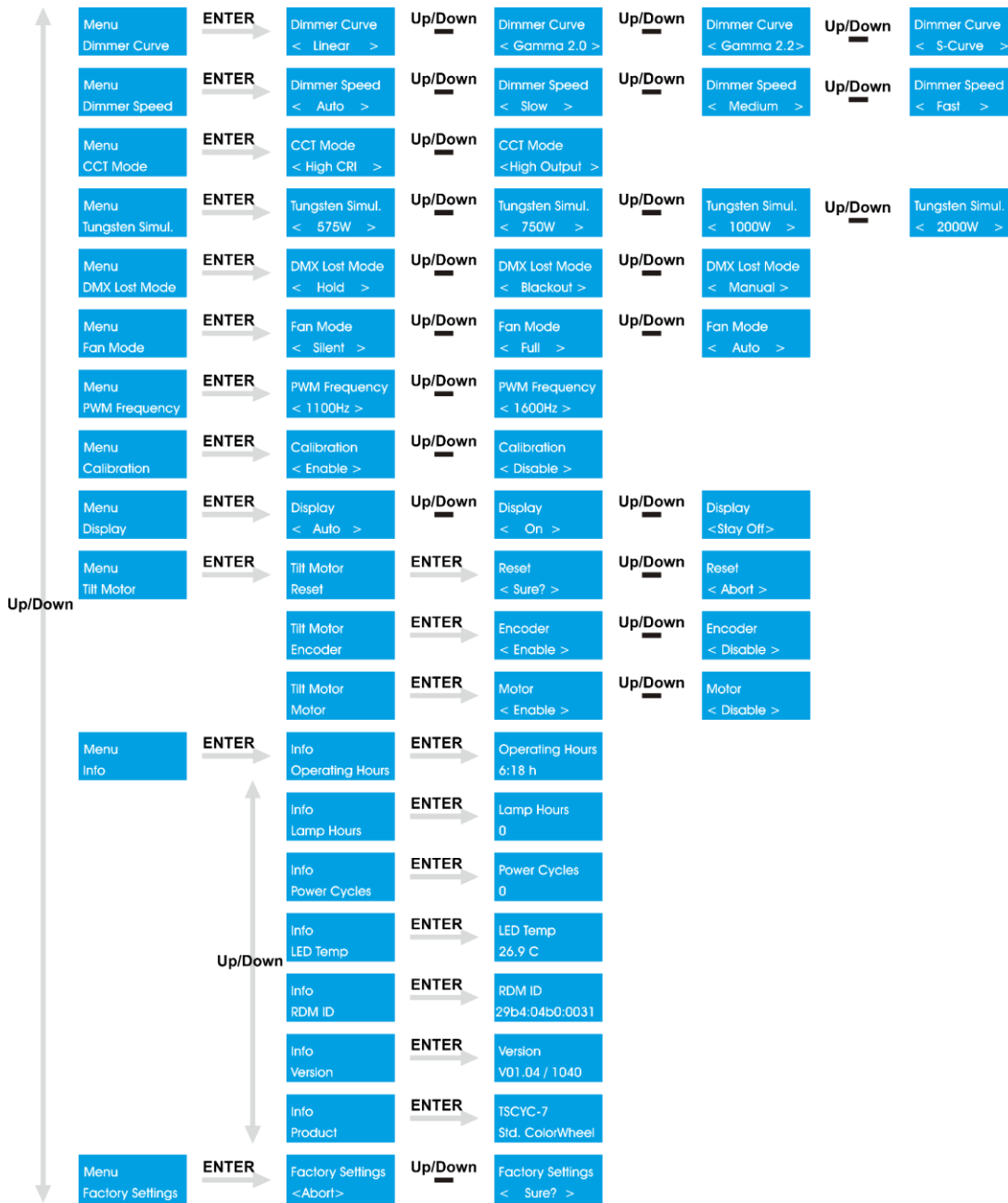

Activate Focus Mode









Press and hold down the **Home button** (B) for 2 sec. The output will be open white 3200K (Focus mode). The device automatically returns to normal mode after 3 min. or when the **Home button** is pressed again.

Main Menu Options

Menu DMX Mode	DMX Configuration
Menu DMX Address	DMX Address
Menu Manual	Manual mode
Menu Dimmer Curve	Dimmer curves
Menu Dimmer Speed	Dimmer speed
Menu CCT Mode	CCT mode
Menu Tungsten Simul.	Tungsten mode
Menu DMX Lost Mode	DMX Lost mode
Menu Fan Mode	Fan mode
Menu PWM Frequency	PWM Frequency
Menu Calibration	Calibration
Menu Display	Display
Menu Tilt Motor	Tilt Motor
Menu Info	Info
Menu Factory Settings	Reset factory settings



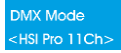

1. DMX Configuration

In this menu you can choose a DMX configuration.

- 01) While in the main menu, press the **UP/DOWN** buttons until the display shows .
- 02) Press the **ENTER** button to open the menu.
- 03) Press the **UP/DOWN** buttons to choose one of the 7 channel modes , , , , ,  or .
- 04) Press the **ENTER** button to confirm.

2. DMX Address





In this menu you can set the DMX address.

- 01) While in the main menu, press the **UP/DOWN** buttons until the display shows .
- 02) Press the **ENTER** button to open the menu.
- 03) Press the **UP/DOWN** buttons to set the device's DMX starting address. The adjustment range is between   .
- 04) Press the **ENTER** button to confirm.

3. Manual





In this menu you can set the manual settings from the Cyclorama.

- 01) While in the main menu, press the **UP/DOWN** buttons until the display shows .
- 02) Press the **ENTER** button to open the submenu.
- 03) Press the **UP/DOWN** buttons to choose between 4 options:



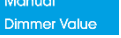

-  Dimmer
-  Color temperature
-  Color wheel
-  Tilt Position

- 04) Press the **ENTER** button to confirm.

3.1 Dimmer

- 01) Press the **UP/DOWN** buttons until the display shows .
- 02) Press the **ENTER** button to open the submenu.
- 03) Press the **UP/DOWN** buttons to set the dimmer value. The adjustment range is between   .
- 04) Press the **ENTER** button to confirm.

3.2 Color Temperature

- 01) Press the **UP/DOWN** buttons until the display shows .
- 02) Press the **ENTER** button to open the submenu.
- 03) Press the **UP/DOWN** buttons to set the color temperature. The adjustment range is between   , in increments of 50K.
- 04) Press the **ENTER** button to confirm.

3.3 Color Wheel

- 01) Press the **UP/DOWN** buttons until the display shows Manual Colorwheel.
- 02) Press the **ENTER** button to open the submenu.
- 03) Press the **UP/DOWN** buttons to choose one of the 64 preset colors and white:

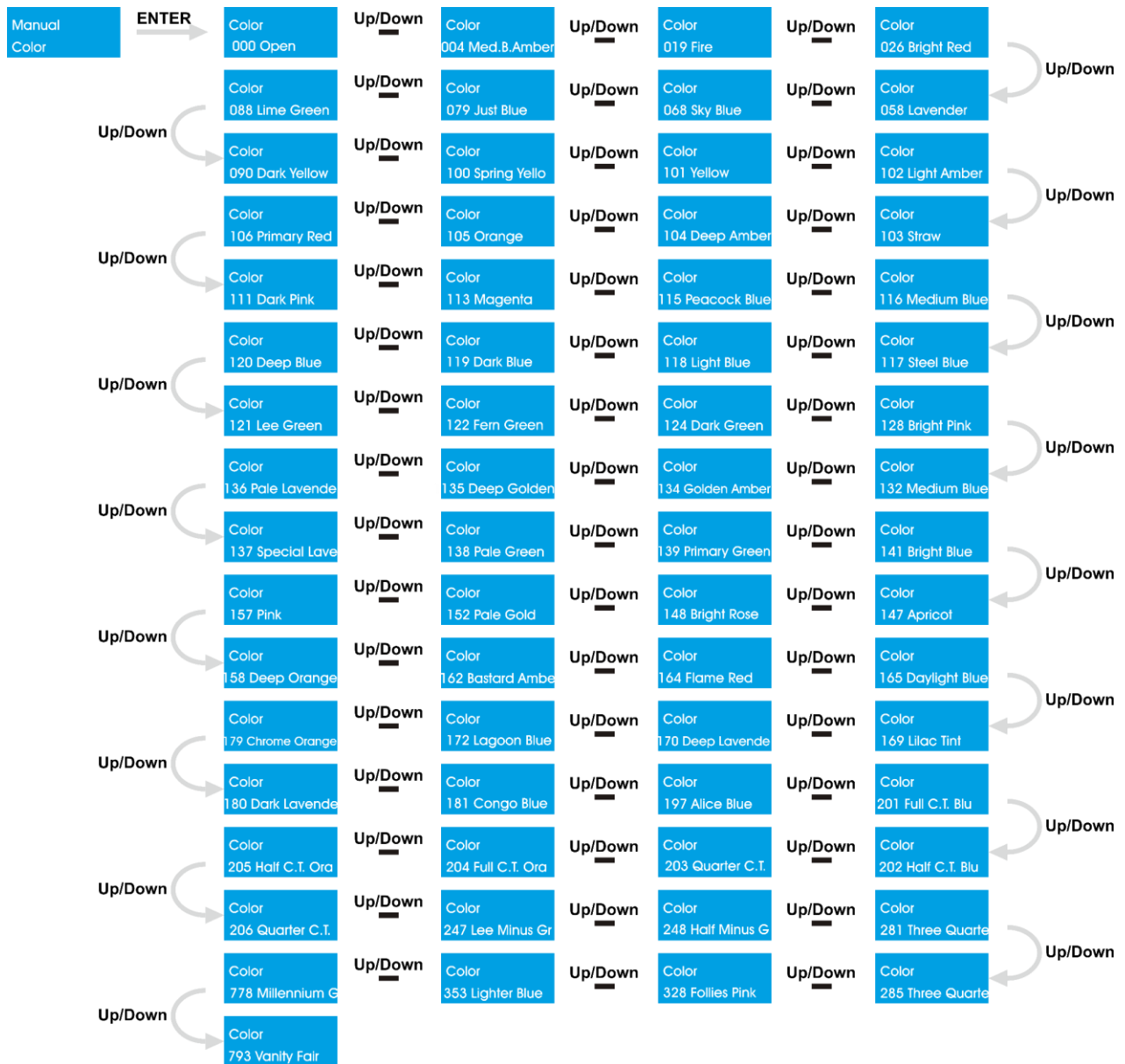

- 04) Press the **ENTER** button to confirm.

3.4 Tilt Position

- 05) Press the **UP/DOWN** buttons until the display shows Manual Tilt Position.
- 06) Press the **ENTER** button to open the submenu.
- 07) Press the **UP/DOWN** buttons to set the tilt value. The adjustment range is between

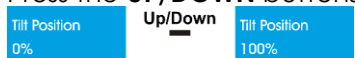

- 08) Press the **ENTER** button to confirm.

4. Dimmer Curves

In this menu you can choose a dimmer curve.

- 01) While in the main menu, press the **UP/DOWN** buttons until the display shows Menu
Dimmer Curve.
- 02) Press the **ENTER** button to open the menu.
- 03) Press the **UP/DOWN** buttons to choose from the 4 available options:

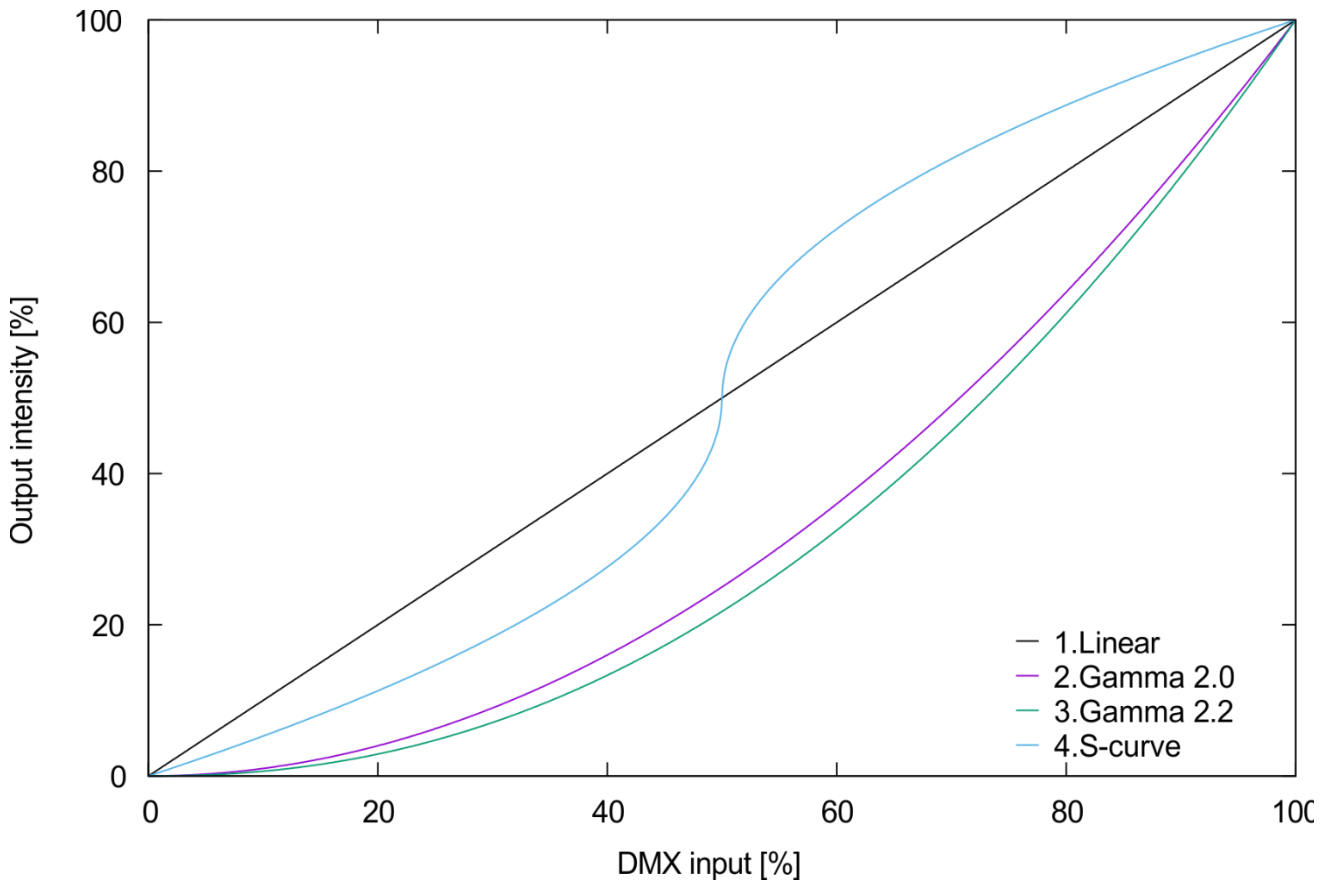

- 04) Press the **ENTER** button to confirm.

5. Dimmer Speed

In this menu you can set the dimmer speed.

- 01) While in the main menu, press the **UP/DOWN** buttons until the display shows Menu
Dimmer Speed.
- 02) Press the **ENTER** button to open the menu.
- 03) Press the **UP/DOWN** buttons to set the dimmer speed. Choose one of the 4 options



- 04) Press the **ENTER** button to confirm.

6. CCT Mode

In this menu you can choose between different outputs in the CCT mode.

- 01) While in the main menu, press the **UP/DOWN** buttons until the display shows Menu
CCT Mode.
- 02) Press the **ENTER** button to open the menu.
- 03) Press the **UP/DOWN** buttons to choose between CCT Mode
< High CRI > and CCT Mode
< High Output >.
- 04) If you choose CCT Mode
< High CRI >, the color rendering index is maximized at the expense of the output. The device reaches a minimum of 96 CRI with a maximum of 97,7. This is reached around 3000K.
- 05) If you choose CCT Mode
< High Output >, it will maximize the output at the expense of a lower CRI. The CRI will be reduced to at least 93 CRI while delivering between 20-30% of additional brightness depending on the color temperature.
- 06) Press the **ENTER** button to confirm.

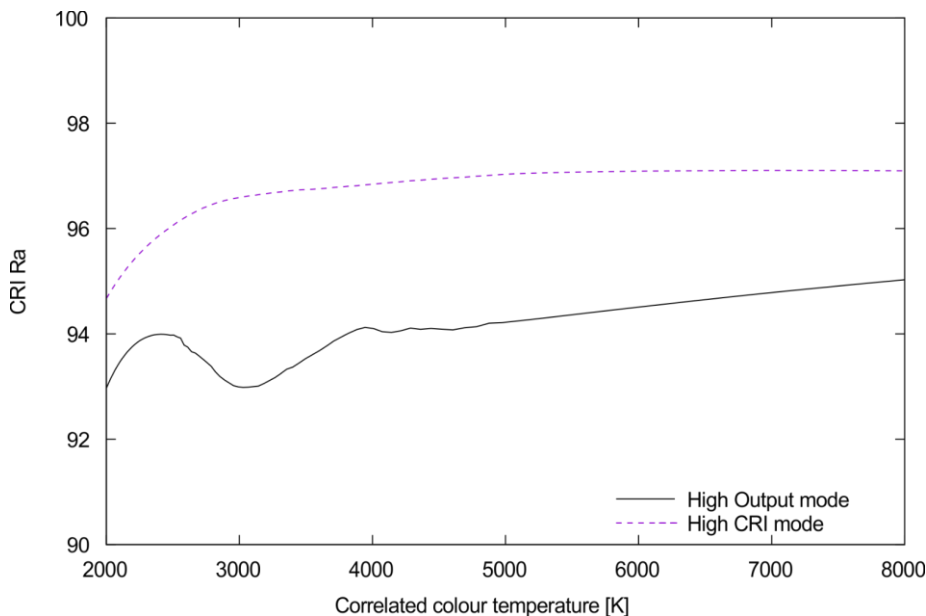

7. Tungsten Simulation

In this menu you can simulate several outputs of a Tungsten fixture.

- 01) While in the main menu, press the **UP/DOWN** buttons until the display shows Menu
Tungsten Simul..
- 02) Press the **ENTER** button to open the menu.
- 03) Press the **UP/DOWN** buttons to choose the desired output. Choose one of the 4 options Tungsten Simul.
< 575W > Up/Down Tungsten Simul.
< 750W > Up/Down Tungsten Simul.
< 1000W > Up/Down Tungsten Simul.
< 2000W >.
- 04) Press the **ENTER** button to confirm.
- 05) In Tungsten mode, the fixture will use its own special Dimmer curve, so you can't use the dimmer curves from the main menu. They won't work in the Tungsten mode.
- 06) In Tungsten mode, the fixture uses its own dimmer timing, so Dimmer Speed will not work either.

8. DMX Lost Mode

In this menu you can determine the behaviour of the Cyclorama in case of a DMX failure. The display will blink (only if Display set to "Auto Off").

- 01) While in the main menu, press the **UP/DOWN** buttons until the display shows .
- 02) Press the **ENTER** button to open the menu.
- 03) Press the **UP/DOWN** buttons to choose one of the 3 options:

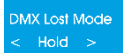

The device will fall back on the last properly working DMX signal from before the DMX signal error, which ensures uninterrupted performance.



The device will black out in case of a DMX failure.

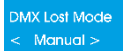

The device will fall back on the last working settings from Manual mode.

- 04) Press the **ENTER** button to confirm.

9. Fan Mode

In this menu you can control the speed of the fan.

- 01) While in the main menu, press the **UP/DOWN** buttons until the display shows .
- 02) Press the **ENTER** button to open the menu.
- 03) Press the **UP/DOWN** buttons to set the speed of the fan. Choose one of the 3 options



- 04) Press the **ENTER** button to confirm.

10. PWM Frequency

In this menu you can set the PWM frequency.

- 01) While in the main menu, press the **UP/DOWN** buttons until the display shows .
- 02) Press the **ENTER** button to open the menu.
- 03) Press the **UP/DOWN** buttons to set the device's PWM frequency. The adjustment range is between

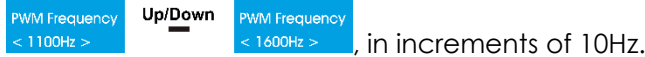

- 04) Press the **ENTER** button to confirm.

11. Calibration

In this menu you can enable or disable the color calibration software.

- 01) While in the main menu, press the **UP/DOWN** buttons until the display shows .
- 02) Press the **ENTER** button to open the menu.

- 03) Press the **UP/DOWN** buttons to choose between  and .



- 04) If you choose , the color calibration software will be activated (recommended).

- 05) Press the **ENTER** button to confirm.

12. Display

In this menu you can set the backlight of the display.

- 01) While in the main menu, press the **UP/DOWN** buttons until the display shows .
- 02) Press the **ENTER** button to open the menu.
- 03) Press the **UP/DOWN** buttons to choose one of the 3 options:



- | | |
|---|--|
|  | The display will turn off in 60 seconds. |
|  | The display will be continuously on. |
|  | The display will be off. |

Press the **ENTER** button to confirm your choice.

13. Tilt Motor





In this menu you can set the tilt angle of the device.

- 01) While in the main menu, press the **UP/DOWN** buttons until the display shows .
- 02) Press the **ENTER** button to open the menu.
- 03) Press the **UP/DOWN** buttons to choose one of the 3 options:



- | | |
|--|---------------------|
|  | Tilt Motor, reset |
|  | Tilt Motor, encoder |
|  | Tilt Motor, motor. |

- 04) Press the **ENTER** button to confirm.

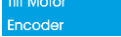
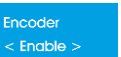
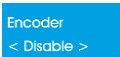

13.1 Tilt Motor Reset

- 01) Press the **UP/DOWN** buttons until the display shows .
- 02) Press the **ENTER** button to open the submenu.
- 03) Press the **UP/DOWN** buttons to choose between  and .
- 04) If you choose , the tilt motor will reset.
- 05) Press the **ENTER** button to confirm.

13.2 Tilt Motor Encoder

- 06) Press the **UP/DOWN** buttons until the display shows .
- 07) Press the **ENTER** button to open the submenu.
- 08) Press the **UP/DOWN** buttons to choose between  and .
- 09) If you choose , the encoder will be activated.
- 10) Press the **ENTER** button to confirm.

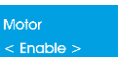



















13.3 Tilt Motor On/OFF

- 11) Press the **UP/DOWN** buttons until the display shows .
- 12) Press the **ENTER** button to open the submenu.
- 13) Press the **UP/DOWN** buttons to choose between  and .
- 14) If you choose , the motor will be activated. You can manually set the inclination angle.
- 15) Press the **ENTER** button to confirm.

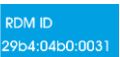
14. Info

In this menu you can view the information about the device.

- 01) While in the main menu, press the **UP/DOWN** buttons until the display shows .
- 02) Press the **ENTER** button to open the menu.
- 03) The display will show:



			Operating hours device
			Actual Lamp hours
			Number of times the device has been started up
			LED Temperature
			RDM identification number
			Current Software version
			Product Name

- 04) Press the **UP/DOWN** buttons to scroll through the options.
- 05) Press the **ENTER** button to confirm.

15. Reset Factory Settings

In this menu you can reset to the default settings.

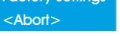
- 01) While in the main menu, press the **UP/DOWN** buttons until the display shows .
- 02) Press the **ENTER** button to open the menu.

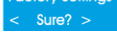
- 03) Press the **UP/DOWN** buttons to choose between   .
- 04) Press the **ENTER** button to confirm your choice.

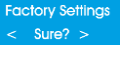
- 05) If you choose , the device will not reset to its default settings.
- 06) If you choose , press the **ENTER** button to confirm.
- 07) The device will now reset to its default settings.

DMX Channels Quickguide

Infinity TCYC-7	Dimmer	Basic	Thungsten	RGB Pro	CMY	HSI Pro	RAW
7Color Profile	Mode (1CH)	Mode (6CH)	Mode (7CH)	Mode (11CH)	Mode (11CH)	Mode (11CH)	Mode (21CH)
Dimmer Coarse	1	1	1	1	1	1	1
Dimmer Fine			2	2	2	2	2
Strobe		2	3	3	3	3	3
CCT		3		4	4	4	
Color Wheel		4	4	8	8	8	18
CW Crossfade		5	5	9	9	9	19
Hue Coarse						5	
Hue Fine						6	
Saturation						7	
Red Coarse				5			4
Red Fine							5
Green Coarse				6			10
Green Fine							11
Blue Coarse				7			14
Blue Fine							15
Cyan Coarse					5		12
Cyan Fine							13
Magenta					6		
Yellow					7		
Amber Coarse							6
Amber Fine							7
Lime Coarse							8
Lime Fine							9
Deep Blue Coarse							16
Deep Blue Fine							17
Tilt Control		6	6	10	10	10	20
Control			7	11	11	11	21

DMX Channels

1 Channel (Basic)

Channel 1 – Dimmer Coarse

0-255 Dimmer intensity, from dark to brightest 0-100%

6 Channels (Basic)

Channel 1 – Dimmer Coarse

0-255 Dimmer intensity, from dark to brightest 0-100%

Channel 2 – Shutter/Strobe

0-5 Closed

6-249 Strobe frequency, from low to high frequency

250-255 Open

Channel 3 – Color Temperature (CCT) (CH1 must be set between 1-255 and CH2 between 6-255)

0-96 2000K-2800K

97-98 2800K

99-112 2800K-3000K

113-114 3000K

115-126 3000K-3200K

127-129 3200K

130-169 3200K-4000K

170-171 4000K

172-218 4000K-5600K

219-220 5600K

221-226 5600K-6000K

227-228 6000K

229-254 6000K-8000K

255 8000K

Channel 4 – Color wheel (CH1 must be set between 1-255 and CH2 between 6-255)

0-7 No function

8-10 Medium bastard amber Lee 004

11-13 Fire Lee 019

14-16 Bright red Lee 026

17-19 Lavender Lee 058

20-22 Sky blue Lee 068

23-25 Just blue Lee 079

26-28 Lime green Lee 088

29-31 Dark yellow green Lee 090

32-34 Spring green Lee 100

35-37 Yellow Lee 101

38-40 Light amber Lee 102

41-43 Straw Lee 103

44-46 Deep amber Lee 104

47-49 Orange Lee 105

50-52 Primary red Lee 106

53-55 Dark pink Lee 111

56-58 Magenta Lee 113

59-61 Peacock blue Lee 115

62-64 Medium blue green Lee 116

65-67 Steel blue Lee 117

68-70	Light blue	Lee 118
71-73	Dark blue	Lee 119
74-76	Deep blue	Lee 120
77-79	Lee green	Lee 121
80-82	Fern green	Lee 122
83-85	Dark green	Lee 124
86-88	Bright pink	Lee 128
89-91	Medium blue	Lee 132
92-94	Golden amber	Lee 134
95-97	Deep golden amber	Lee 135
98-100	Pale lavender	Lee 136
101-103	Special lavender	Lee 137
104-106	Pale green	Lee 138
107-109	Primary green	Lee 139
110-112	Bright blue	Lee 141
113-115	Apricot	Lee 147
116-118	Bright rose	Lee 148
119-121	Pale gold	Lee 152
122-124	Pink	Lee 157
125-127	Deep orange	Lee 158
128-130	Bastard amber	Lee 162
131-133	Flame red	Lee 164
134-136	Daylight blue	Lee 165
137-139	Lilac tint	Lee 169
140-142	Deep lavender	Lee 170
143-145	Lagoon blue	Lee 172
146-148	Chrome orange	Lee 179
149-151	Dark lavender	Lee 180
152-154	Congo blue	Lee 181
155-157	Alice blue	Lee 197
158-160	Full CT blue	Lee 201
161-163	Half CT blue	Lee 202
164-166	Quarter CT Blue	Lee 203
167-169	Full CT orange	Lee 204
170-172	Half CT orange	Lee 205
173-175	Quarter CT orange	Lee 206
176-178	Filter minus green	Lee 247
179-181	Half minus green	Lee 248
182-184	Three quarter CT blue	Lee 281
185-187	Three quarter CT orange	Lee 285
188-190	Follies pink	Lee 328
191-193	Lighter blue	Lee 353
194-196	Millenium gold	Lee 778
197-199	Vanity fair	Lee 793
200-255	Reserved	

Channel 5 – Color wheel crossfade time wheel (CH4 must be set between 7-255 )

0-1	0,1 sec. crossfade
1-2	0,2 sec. crossfade
2-3	0,3 sec. crossfade

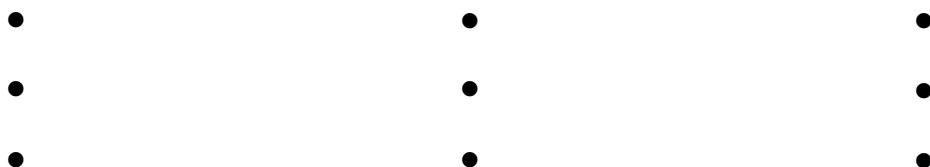

252-253	25,3 sec. crossfade
253-254	25,4 sec. crossfade
254-255	25,5 sec. crossfade

Note: The color wheel crossfade time is the time which needs to pass before the device fades from color 1 to color 2.

Channel 6 – Vertical movement (Tilt)

Move the slider up, in order to move head vertically (TILT).

Gradual head adjustment from one end of the slider to the other (0-255, 128-center).

The head can be turned by 30° and stopped at any position you wish.

7 Channels (Thungsten)

Channel 1 – Dimmer Coarse

0-255	Dimmer intensity, from dark to brightest 0-100%
-------	---

Channel 2 – Dimmer Fine

0-255	Dimmer fine intensity, from dark to brightest 0-100%
-------	--

Channel 3 – Shutter/Strobe

0-5	Closed
6-249	Strobe frequency, from low to high frequency
250-255	Open

Channel 4 – Color wheel (CH1 must be set between 1-255 and CH3 between 6-255)

0-7	No function	
8-10	Medium bastard amber	Lee 004
11-13	Fire	Lee 019
14-16	Bright red	Lee 026
17-19	Lavender	Lee 058
20-22	Sky blue	Lee 068
23-25	Just blue	Lee 079
26-28	Lime green	Lee 088
29-31	Dark yellow green	Lee 090
32-34	Spring green	Lee 100
35-37	Yellow	Lee 101
38-40	Light amber	Lee 102
41-43	Straw	Lee 103
44-46	Deep amber	Lee 104
47-49	Orange	Lee 105
50-52	Primary red	Lee 106
53-55	Dark pink	Lee 111
56-58	Magenta	Lee 113
59-61	Peacock blue	Lee 115
62-64	Medium blue green	Lee 116
65-67	Steel blue	Lee 117
68-70	Light blue	Lee 118
71-73	Dark blue	Lee 119
74-76	Deep blue	Lee 120
77-79	Lee green	Lee 121
80-82	Fern green	Lee 122
83-85	Dark green	Lee 124
86-88	Bright pink	Lee 128
89-91	Medium blue	Lee 132
92-94	Golden amber	Lee 134
95-97	Deep golden amber	Lee 135

98-100	Pale lavender	Lee 136
101-103	Special lavender	Lee 137
104-106	Pale green	Lee 138
107-109	Primary green	Lee 139
110-112	Bright blue	Lee 141
113-115	Apricot	Lee 147
116-118	Bright rose	Lee 148
119-121	Pale gold	Lee 152
122-124	Pink	Lee 157
125-127	Deep orange	Lee 158
128-130	Bastard amber	Lee 162
131-133	Flame red	Lee 164
134-136	Daylight blue	Lee 165
137-139	Lilac tint	Lee 169
140-142	Deep lavender	Lee 170
143-145	Lagoon blue	Lee 172
146-148	Chrome orange	Lee 179
149-151	Dark lavender	Lee 180
152-154	Congo blue	Lee 181
155-157	Alice blue	Lee 197
158-160	Full CT blue	Lee 201
161-163	Half CT blue	Lee 202
164-166	Quarter CT Blue	Lee 203
167-169	Full CT orange	Lee 204
170-172	Half CT orange	Lee 205
173-175	Quarter CT orange	Lee 206
176-178	Filter minus green	Lee 247
179-181	Half minus green	Lee 248
182-184	Three quarter CT blue	Lee 281
185-187	Three quarter CT orange	Lee 285
188-190	Follies pink	Lee 328
191-193	Lighter blue	Lee 353
194-196	Millenium gold	Lee 778
197-199	Vanity fair	Lee 793
200-255	Reserved	

Channel 5 – Color wheel crossfade time wheel (CH4 must be set between 7-255)

0-1	0,1 sec. crossfade
1-2	0,2 sec. crossfade
2-3	0,3 sec. crossfade
	● ● ●
	● ● ●
	● ● ●
252-253	25,3 sec. crossfade
253-254	25,4 sec. crossfade
254-255	25,5 sec. crossfade

Note: The color wheel crossfade time is the time which needs to pass before the device fades from color 1 to color 2.

Channel 6 – Vertical movement (Tilt)

Move the slider up, in order to move head vertically (TILT).

Gradual head adjustment from one end of the slider to the other (0-255, 128-center).

The head can be turned by 30° and stopped at any position you wish.

Channel 7 – Control mode (Hold DMX value for at least 3 sec. before the function takes effect)

0-7	No function
8-15	Dimmer curve 1: Linear
16-23	Dimmer curve 2: Gamma 2.0
24-31	Dimmer curve 3: Gamma 2.2
32-39	Dimmer curve 4: S-curve
40-71	No function
72-79	Simulation source: Tungsten 575W
80-87	Simulation source: Tungsten 750W
88-95	Simulation source: Tungsten 1000W
96-103	Simulation source: Tungsten 2000W
104-111	PWM speed: 1,1 kHz
112-119	PWM speed: 1,2 kHz
120-127	PWM speed: 1,3 kHz
128-135	PWM speed: 1,4 kHz
136-143	PWM speed: 1,5 kHz
144-151	PWM speed: 1,6 kHz
152-159	Calibration disabled
160-167	Calibration enabled
168-175	Fan mode: silent
176-183	Fan mode: auto
184-191	Fan mode: full
192-199	Graphic display: auto off
200-207	Graphic display: on
208-215	CCT mode: High CRI
216-223	CCT mode: High Output
224-249	No function
250	Reset all
251-255	No function

11 Channels (RGB Pro Mode)

Channel 1 – Dimmer Coarse

0-255	Dimmer intensity, from dark to brightest 0-100%
-------	---

Channel 2 – Dimmer Fine

0-255	Dimmer fine intensity, from dark to brightest 0-100%
-------	--

Channel 3 – Shutter/Strobe

0-5	Closed
6-249	Strobe frequency, from low to high frequency
250-255	Open

Channel 4 – Color Temperature (CCT) (CH1 must be set between 1-255 and CH3 between 6-255)

0-96	2000K-2800K
97-98	2800K
99-112	2800K-3000K
113-114	3000K
115-126	3000K-3200K
127-129	3200K
130-169	3200K-4000K
170-171	4000K
172-218	4000K-5600K
219-220	5600K
221-226	5600K-6000K
227-228	6000K

229-254	6000K-8000K
255	8000K

Channel 5 – Red Dimmer Coarse (CH1 must be set between 1-255 and CH3 between 6-255 )

0-255	Gradual adjustment Red from 0-100%
-------	------------------------------------

Channel 6 – Green Dimmer Coarse (CH1 must be set between 1-255 and CH3 between 6-255 )

0-255	Gradual adjustment Green from 0-100%
-------	--------------------------------------

Channel 7 – Blue Dimmer Coarse (CH1 must be set between 1-255 and CH3 between 6-255 )

0-255	Gradual adjustment Blue from 0-100%
-------	-------------------------------------

Channel 8 – Color wheel (CH1 must be set between 1-255 and CH3 between 6-255 )

0-7	No function	
8-10	Medium bastard amber	Lee 004
11-13	Fire	Lee 019
14-16	Bright red	Lee 026
17-19	Lavender	Lee 058
20-22	Sky blue	Lee 068
23-25	Just blue	Lee 079
26-28	Lime green	Lee 088
29-31	Dark yellow green	Lee 090
32-34	Spring green	Lee 100
35-37	Yellow	Lee 101
38-40	Light amber	Lee 102
41-43	Straw	Lee 103
44-46	Deep amber	Lee 104
47-49	Orange	Lee 105
50-52	Primary red	Lee 106
53-55	Dark pink	Lee 111
56-58	Magenta	Lee 113
59-61	Peacock blue	Lee 115
62-64	Medium blue green	Lee 116
65-67	Steel blue	Lee 117
68-70	Light blue	Lee 118
71-73	Dark blue	Lee 119
74-76	Deep blue	Lee 120
77-79	Lee green	Lee 121
80-82	Fern green	Lee 122
83-85	Dark green	Lee 124
86-88	Bright pink	Lee 128
89-91	Medium blue	Lee 132
92-94	Golden amber	Lee 134
95-97	Deep golden amber	Lee 135
98-100	Pale lavender	Lee 136
101-103	Special lavender	Lee 137
104-106	Pale green	Lee 138
107-109	Primary green	Lee 139
110-112	Bright blue	Lee 141
113-115	Apricot	Lee 147
116-118	Bright rose	Lee 148
119-121	Pale gold	Lee 152
122-124	Pink	Lee 157
125-127	Deep orange	Lee 158
128-130	Bastard amber	Lee 162

131-133	Flame red	Lee 164
134-136	Daylight blue	Lee 165
137-139	Lilac tint	Lee 169
140-142	Deep lavender	Lee 170
143-145	Lagoon blue	Lee 172
146-148	Chrome orange	Lee 179
149-151	Dark lavender	Lee 180
152-154	Congo blue	Lee 181
155-157	Alice blue	Lee 197
158-160	Full CT blue	Lee 201
161-163	Half CT blue	Lee 202
164-166	Quarter CT Blue	Lee 203
167-169	Full CT orange	Lee 204
170-172	Half CT orange	Lee 205
173-175	Quarter CT orange	Lee 206
176-178	Filter minus green	Lee 247
179-181	Half minus green	Lee 248
182-184	Three quarter CT blue	Lee 281
185-187	Three quarter CT orange	Lee 285
188-190	Follies pink	Lee 328
191-193	Lighter blue	Lee 353
194-196	Millenium gold	Lee 778
197-199	Vanity fair	Lee 793
200-255	Reserved	

Channel 9 – Color wheel crossfade time wheel (CH4 must be set between 7-255)

0-1	0,1 sec. crossfade
1-2	0,2 sec. crossfade
2-3	0,3 sec. crossfade
	● ● ●
	● ● ●
	● ● ●
252-253	25,3 sec. crossfade
253-254	25,4 sec. crossfade
254-255	25,5 sec. crossfade

Note: The color wheel crossfade time is the time which needs to pass before the device fades from color 1 to color 2.

Channel 10 – Vertical movement (Tilt)

Move the slider up, in order to move head vertically (TILT).
Gradual head adjustment from one end of the slider to the other (0-255, 128-center).
The head can be turned by 30° and stopped at any position you wish.

Channel 11 – Control mode (Hold DMX value for at least 3 sec. before the function takes effect)

0-7	No function
8-15	Dimmer curve 1: Linear
16-23	Dimmer curve 2: Gamma 2.0
24-31	Dimmer curve 3: Gamma 2.2
32-39	Dimmer curve 4: S-curve
40-71	No function
72-79	Simulation source: Tungsten 575W
80-87	Simulation source: Tungsten 750W
88-95	Simulation source: Tungsten 1000W

96-103	Simulation source: Tungsten 2000W
104-111	PWM speed: 1,1 kHz
112-119	PWM speed: 1,2 kHz
120-127	PWM speed: 1,3 kHz
128-135	PWM speed: 1,4 kHz
136-143	PWM speed: 1,5 kHz
144-151	PWM speed: 1,6 kHz
152-159	Calibration disabled
160-167	Calibration enabled
168-175	Fan mode: silent
176-183	Fan mode: auto
184-191	Fan mode: full
192-199	Graphic display: auto off
200-207	Graphic display: on
208-215	CCT mode: High CRI
216-223	CCT mode: High Output
224-249	No function
250	Reset all
251-255	No function

11 Channels (CMY Pro Mode)

Channel 1 – Dimmer Coarse

0-255 Dimmer intensity, from dark to brightest 0-100%

Channel 2 – Dimmer Fine

0-255 Dimmer fine intensity, from dark to brightest 0-100%

Channel 3 – Shutter/Strobe

0-5 Closed
 6-249 Strobe frequency, from low to high frequency
 250-255 Open

Channel 4 – Color Temperature (CCT) (CH1 must be set between 1-255 and CH3 between 6-255)

0-96 2000K-2800K
 97-98 2800K
 99-112 2800K-3000K
 113-114 3000K
 115-126 3000K-3200K
 127-129 3200K
 130-169 3200K-4000K
 170-171 4000K
 172-218 4000K-5600K
 219-220 5600K
 221-226 5600K-6000K
 227-228 6000K
 229-254 6000K-8000K
 255 8000K

Channel 5 – Cyan Dimmer Coarse (CH1 must be set between 1-255 and CH3 between 6-255)

0-255 Gradual adjustment Cyan from 0-100%

Channel 6 – Magenta Dimmer Coarse (CH1 must be set between 1-255 and CH3 between 6-255)

0-255 Gradual adjustment Magenta from 0-100%

Channel 7 – Yellow Dimmer Coarse (CH1 must be set between 1-255 and CH3 between 6-255 )
 0-255 Gradual adjustment Yellow from 0-100%

Channel 8 – Color wheel (CH1 must be set between 1-255 and CH3 between 6-255 )

0-7	No function	
8-10	Medium bastard amber	Lee 004
11-13	Fire	Lee 019
14-16	Bright red	Lee 026
17-19	Lavender	Lee 058
20-22	Sky blue	Lee 068
23-25	Just blue	Lee 079
26-28	Lime green	Lee 088
29-31	Dark yellow green	Lee 090
32-34	Spring green	Lee 100
35-37	Yellow	Lee 101
38-40	Light amber	Lee 102
41-43	Straw	Lee 103
44-46	Deep amber	Lee 104
47-49	Orange	Lee 105
50-52	Primary red	Lee 106
53-55	Dark pink	Lee 111
56-58	Magenta	Lee 113
59-61	Peacock blue	Lee 115
62-64	Medium blue green	Lee 116
65-67	Steel blue	Lee 117
68-70	Light blue	Lee 118
71-73	Dark blue	Lee 119
74-76	Deep blue	Lee 120
77-79	Lee green	Lee 121
80-82	Fern green	Lee 122
83-85	Dark green	Lee 124
86-88	Bright pink	Lee 128
89-91	Medium blue	Lee 132
92-94	Golden amber	Lee 134
95-97	Deep golden amber	Lee 135
98-100	Pale lavender	Lee 136
101-103	Special lavender	Lee 137
104-106	Pale green	Lee 138
107-109	Primary green	Lee 139
110-112	Bright blue	Lee 141
113-115	Apricot	Lee 147
116-118	Bright rose	Lee 148
119-121	Pale gold	Lee 152
122-124	Pink	Lee 157
125-127	Deep orange	Lee 158
128-130	Bastard amber	Lee 162
131-133	Flame red	Lee 164
134-136	Daylight blue	Lee 165
137-139	Lilac tint	Lee 169
140-142	Deep lavender	Lee 170
143-145	Lagoon blue	Lee 172
146-148	Chrome orange	Lee 179
149-151	Dark lavender	Lee 180
152-154	Congo blue	Lee 181
155-157	Alice blue	Lee 197
158-160	Full CT blue	Lee 201

161-163	Half CT blue	Lee 202
164-166	Quarter CT Blue	Lee 203
167-169	Full CT orange	Lee 204
170-172	Half CT orange	Lee 205
173-175	Quarter CT orange	Lee 206
176-178	Filter minus green	Lee 247
179-181	Half minus green	Lee 248
182-184	Three quarter CT blue	Lee 281
185-187	Three quarter CT orange	Lee 285
188-190	Follies pink	Lee 328
191-193	Lighter blue	Lee 353
194-196	Millenium gold	Lee 778
197-199	Vanity fair	Lee 793
200-255	Reserved	

Channel 9 – Color wheel crossfade time wheel (CH4 must be set between 7-255)

0-1	0,1 sec. crossfade
1-2	0,2 sec. crossfade
2-3	0,3 sec. crossfade
	● ● ●
	● ● ●
	● ● ●
252-253	25,3 sec. crossfade
253-254	25,4 sec. crossfade
254-255	25,5 sec. crossfade

Note: The color wheel crossfade time is the time which needs to pass before the device fades from color 1 to color 2.

Channel 10 – Vertical movement (Tilt)

Move the slider up, in order to move head vertically (TILT).

Gradual head adjustment from one end of the slider to the other (0-255, 128-center).

The head can be turned by 30° and stopped at any position you wish.

Channel 11 – Control mode (Hold DMX value for at least 3 sec. before the function takes effect)

0-7	No function
8-15	Dimmer curve 1: Linear
16-23	Dimmer curve 2: Gamma 2.0
24-31	Dimmer curve 3: Gamma 2.2
32-39	Dimmer curve 4: S-curve
40-71	No function
72-79	Simulation source: Tungsten 575W
80-87	Simulation source: Tungsten 750W
88-95	Simulation source: Tungsten 1000W
96-103	Simulation source: Tungsten 2000W
104-111	PWM speed: 1,1 kHz
112-119	PWM speed: 1,2 kHz
120-127	PWM speed: 1,3 kHz
128-135	PWM speed: 1,4 kHz
136-143	PWM speed: 1,5 kHz
144-151	PWM speed: 1,6 kHz
152-159	Calibration disabled
160-167	Calibration enabled
168-175	Fan mode: silent

176-183	Fan mode: auto
184-191	Fan mode: full
192-199	Graphic display: auto off
200-207	Graphic display: on
208-215	CCT mode: High CRI
216-223	CCT mode: High Output
224-249	No function
250	Reset all
251-255	No function

11 Channels (HSI Pro Mode)

Channel 1 – Dimmer Coarse

0-255	Dimmer intensity, from dark to brightest 0-100%
-------	---

Channel 2 – Dimmer Fine

0-255	Dimmer fine intensity, from dark to brightest 0-100%
-------	--

Channel 3 – Shutter/Strobe

0-5	Closed
6-249	Strobe frequency, from low to high frequency
250-255	Open

Channel 4 – Color Temperature (CCT) (CH1 must be set between 1-255 and CH3 between 6-255)

0-96	2000K-2800K
97-98	2800K
99-112	2800K-3000K
113-114	3000K
115-126	3000K-3200K
127-129	3200K
130-169	3200K-4000K
170-171	4000K
172-218	4000K-5600K
219-220	5600K
221-226	5600K-6000K
227-228	6000K
229-254	6000K-8000K
255	8000K

Channel 5 – Hue Coarse (color variations) (CH1 must be set between 1-255, CH3 between 6-255 and CH7 between 1-255)

0-255	Gradual adjustment Hue from 0-100%
-------	------------------------------------

Channel 6 – Hue Fine (color variations) (CH1 must be set between 1-255, CH3 between 6-255 and CH7 between 1-255 )

0-255 Gradual adjustment Hue fine from 0-100%

Channel 7 – Color saturation (CH1 must be set between 1-255 and CH3 between 6-255 )

0-255 Gradual Color saturation adjustment from 0-100%

Channel 8 – Color wheel (CH1 must be set between 1-255 and CH3 between 6-255 )

0-7	No function	
8-10	Medium bastard amber	Lee 004
11-13	Fire	Lee 019
14-16	Bright red	Lee 026
17-19	Lavender	Lee 058
20-22	Sky blue	Lee 068
23-25	Just blue	Lee 079
26-28	Lime green	Lee 088
29-31	Dark yellow green	Lee 090
32-34	Spring green	Lee 100
35-37	Yellow	Lee 101
38-40	Light amber	Lee 102
41-43	Straw	Lee 103
44-46	Deep amber	Lee 104
47-49	Orange	Lee 105
50-52	Primary red	Lee 106
53-55	Dark pink	Lee 111
56-58	Magenta	Lee 113
59-61	Peacock blue	Lee 115
62-64	Medium blue green	Lee 116
65-67	Steel blue	Lee 117
68-70	Light blue	Lee 118
71-73	Dark blue	Lee 119
74-76	Deep blue	Lee 120
77-79	Lee green	Lee 121
80-82	Fern green	Lee 122
83-85	Dark green	Lee 124
86-88	Bright pink	Lee 128
89-91	Medium blue	Lee 132
92-94	Golden amber	Lee 134
95-97	Deep golden amber	Lee 135
98-100	Pale lavender	Lee 136
101-103	Special lavender	Lee 137
104-106	Pale green	Lee 138
107-109	Primary green	Lee 139
110-112	Bright blue	Lee 141
113-115	Apricot	Lee 147
116-118	Bright rose	Lee 148
119-121	Pale gold	Lee 152
122-124	Pink	Lee 157
125-127	Deep orange	Lee 158
128-130	Bastard amber	Lee 162
131-133	Flame red	Lee 164
134-136	Daylight blue	Lee 165
137-139	Lilac tint	Lee 169
140-142	Deep lavender	Lee 170
143-145	Lagoon blue	Lee 172

146-148	Chrome orange	Lee 179
149-151	Dark lavender	Lee 180
152-154	Congo blue	Lee 181
155-157	Alice blue	Lee 197
158-160	Full CT blue	Lee 201
161-163	Half CT blue	Lee 202
164-166	Quarter CT Blue	Lee 203
167-169	Full CT orange	Lee 204
170-172	Half CT orange	Lee 205
173-175	Quarter CT orange	Lee 206
176-178	Filter minus green	Lee 247
179-181	Half minus green	Lee 248
182-184	Three quarter CT blue	Lee 281
185-187	Three quarter CT orange	Lee 285
188-190	Follies pink	Lee 328
191-193	Lighter blue	Lee 353
194-196	Millenium gold	Lee 778
197-199	Vanity fair	Lee 793
200-255	Reserved	

Channel 9 – Color wheel crossfade time wheel (CH8 must be set between 7-255)

0-1	0,1 sec. crossfade
1-2	0,2 sec. crossfade
2-3	0,3 sec. crossfade
	● ● ●
	● ● ●
	● ● ●
252-253	25,3 sec. crossfade
253-254	25,4 sec. crossfade
254-255	25,5 sec. crossfade

Note: The color wheel crossfade time is the time which needs to pass before the device fades from color 1 to color 2.

Channel 10 – Vertical movement (Tilt)

Move the slider up, in order to move head vertically (TILT).

Gradual head adjustment from one end of the slider to the other (0-255, 128-center).

The head can be turned by 30° and stopped at any position you wish.

Channel 11 – Control mode (Hold DMX value for at least 3 sec. before the function takes effect)

0-7	No function
8-15	Dimmer curve 1: Linear
16-23	Dimmer curve 2: Gamma 2.0
24-31	Dimmer curve 3: Gamma 2.2
32-39	Dimmer curve 4: S-curve
40-71	No function
72-79	Simulation source: Tungsten 575W
80-87	Simulation source: Tungsten 750W
88-95	Simulation source: Tungsten 1000W
96-103	Simulation source: Tungsten 2000W
104-111	PWM speed: 1,1 kHz
112-119	PWM speed: 1,2 kHz
120-127	PWM speed: 1,3 kHz
128-135	PWM speed: 1,4 kHz

136-143	PWM speed: 1,5 kHz
144-151	PWM speed: 1,6 kHz
152-159	Calibration disabled
160-167	Calibration enabled
168-175	Fan mode: silent
176-183	Fan mode: auto
184-191	Fan mode: full
192-199	Graphic display: auto off
200-207	Graphic display: on
208-215	CCT mode: High CRI
216-223	CCT mode: High Output
224-249	No function
250	Reset all
251-255	No function

21 Channels (RAW Mode)

Channel 1 – Dimmer Coarse

0-255 Dimmer intensity, from dark to brightest 0-100%

Channel 2 – Dimmer Fine

0-255 Dimmer fine intensity, from dark to brightest 0-100%

Channel 3 – Shutter/Strobe

0-5 Closed

6-249 Strobe frequency, from low to high frequency

250-255 Open

Channel 4 – Red Dimmer Coarse (CH1 must be set between 1-255, CH3 between 6-255)

0-255 Gradual adjustment Red from 0-100%

Channel 5 – Red Dimmer Fine (CH2 must be set between 1-255, CH3 between 6-255)

0-255 Gradual adjustment Red fine from 0-100%

Channel 6 – Amber Dimmer (CH1 must be set between 1-255, CH3 between 6-255)

0-255 Gradual adjustment Amber from 0-100%

Channel 7 – Amber Dimmer Fine (CH2 must be set between 1-255, CH3 between 6-255)

0-255 Gradual adjustment Amber fine from 0-100%

Channel 8 – Lime Dimmer (CH1 must be set between 1-255, CH3 between 6-255)

0-255 Gradual adjustment Lime from 0-100%

Channel 9 – Lime Dimmer Fine (CH2 must be set between 1-255, CH3 between 6-255)

0-255 Gradual adjustment Lime fine from 0-100%

Channel 10 – Green Dimmer Coarse (CH1 must be set between 1-255, CH3 between 6-255)

0-255 Gradual adjustment Green from 0-100%

Channel 11 – Green Dimmer Fine (CH2 must be set between 1-255, CH3 between 6-255)

0-255 Gradual adjustment Green fine from 0-100%

Channel 12 – Cyan Dimmer Coarse (CH1 must be set between 1-255, CH3 between 6-255 )
 0-255 Gradual adjustment Cyan from 0-100%

Channel 13 – Cyan Dimmer Fine (CH2 must be set between 1-255, CH3 between 6-255 )
 0-255 Gradual adjustment Cyan fine from 0-100%

Channel 14 – Blue Dimmer Coarse (CH1 must be set between 1-255, CH3 between 6-255 )
 0-255 Gradual adjustment Blue from 0-100%

Channel 15 – Blue Dimmer Fine (CH2 must be set between 1-255, CH3 between 6-255 )
 0-255 Gradual adjustment Blue fine from 0-100%

Channel 16 – Deep Blue Dimmer (CH1 must be set between 1-255, CH3 between 6-255 )
 0-255 Gradual adjustment Deep Blue from 0-100%

Channel 17 – Deep Blue Dimmer Fine (CH2 must be set between 1-255, CH3 between 6-255 )
 0-255 Gradual adjustment Deep Blue fine from 0-100%

Channel 18 – Color wheel (CH1 must be set between 1-255 and CH3 between 6-255 )

0-7	No function	
8-10	Medium bastard amber	Lee 004
11-13	Fire	Lee 019
14-16	Bright red	Lee 026
17-19	Lavender	Lee 058
20-22	Sky blue	Lee 068
23-25	Just blue	Lee 079
26-28	Lime green	Lee 088
29-31	Dark yellow green	Lee 090
32-34	Spring green	Lee 100
35-37	Yellow	Lee 101
38-40	Light amber	Lee 102
41-43	Straw	Lee 103
44-46	Deep amber	Lee 104
47-49	Orange	Lee 105
50-52	Primary red	Lee 106
53-55	Dark pink	Lee 111
56-58	Magenta	Lee 113
59-61	Peacock blue	Lee 115
62-64	Medium blue green	Lee 116
65-67	Steel blue	Lee 117
68-70	Light blue	Lee 118
71-73	Dark blue	Lee 119
74-76	Deep blue	Lee 120
77-79	Lee green	Lee 121
80-82	Fern green	Lee 122
83-85	Dark green	Lee 124
86-88	Bright pink	Lee 128
89-91	Medium blue	Lee 132
92-94	Golden amber	Lee 134
95-97	Deep golden amber	Lee 135
98-100	Pale lavender	Lee 136
101-103	Special lavender	Lee 137
104-106	Pale green	Lee 138

107-109	Primary green	Lee 139
110-112	Bright blue	Lee 141
113-115	Apricot	Lee 147
116-118	Bright rose	Lee 148
119-121	Pale gold	Lee 152
122-124	Pink	Lee 157
125-127	Deep orange	Lee 158
128-130	Bastard amber	Lee 162
131-133	Flame red	Lee 164
134-136	Daylight blue	Lee 165
137-139	Lilac tint	Lee 169
140-142	Deep lavender	Lee 170
143-145	Lagoon blue	Lee 172
146-148	Chrome orange	Lee 179
149-151	Dark lavender	Lee 180
152-154	Congo blue	Lee 181
155-157	Alice blue	Lee 197
158-160	Full CT blue	Lee 201
161-163	Half CT blue	Lee 202
164-166	Quarter CT Blue	Lee 203
167-169	Full CT orange	Lee 204
170-172	Half CT orange	Lee 205
173-175	Quarter CT orange	Lee 206
176-178	Filter minus green	Lee 247
179-181	Half minus green	Lee 248
182-184	Three quarter CT blue	Lee 281
185-187	Three quarter CT orange	Lee 285
188-190	Follies pink	Lee 328
191-193	Lighter blue	Lee 353
194-196	Millenium gold	Lee 778
197-199	Vanity fair	Lee 793
200-255	Reserved	

Channel 19 – Color wheel crossfade time wheel (CH4 must be set between 7-255)

0-1	0,1 sec. crossfade
1-2	0,2 sec. crossfade
2-3	0,3 sec. crossfade
	● ● ●
	● ● ●
	● ● ●
252-253	25,3 sec. crossfade
253-254	25,4 sec. crossfade
254-255	25,5 sec. crossfade

Note: The color wheel crossfade time is the time which needs to pass before the device fades from color 1 to color 2.

Channel 20 – Vertical movement (Tilt)

Move the slider up, in order to move head vertically (TILT).
Gradual head adjustment from one end of the slider to the other (0-255, 128-center).
The head can be turned by 30° and stopped at any position you wish.

Channel 21 – Control mode (Hold DMX value for at least 3 sec. before the function takes effect)

0-7	No function
-----	-------------

8-15	Dimmer curve 1: Linear
16-23	Dimmer curve 2: Gamma 2.0
24-31	Dimmer curve 3: Gamma 2.2
32-39	Dimmer curve 4: S-curve
40-71	No function
72-79	Simulation source: Tungsten 575W
80-87	Simulation source: Tungsten 750W
88-95	Simulation source: Tungsten 1000W
96-103	Simulation source: Tungsten 2000W
104-111	PWM speed: 1,1 kHz
112-119	PWM speed: 1,2 kHz
120-127	PWM speed: 1,3 kHz
128-135	PWM speed: 1,4 kHz
136-143	PWM speed: 1,5 kHz
144-151	PWM speed: 1,6 kHz
152-159	Calibration disabled
160-167	Calibration enabled
168-175	Fan mode: silent
176-183	Fan mode: auto
184-191	Fan mode: full
192-199	Graphic display: auto off
200-207	Graphic display: on
208-215	CCT mode: High CRI
216-223	CCT mode: High Output
224-249	No function
250	Reset all
251-255	No function

Maintenance

The Showtec Infinity TCYC-7 Cyclorama requires almost no maintenance. However, you should keep the unit clean. Otherwise, the fixture's light output will be significantly reduced. Disconnect the mains power supply and then wipe the cover with a damp cloth. The front glass panel will require weekly cleaning, as smoke-fluid tends to build up residues, reducing the light output very quickly. Do not immerse in liquid. Keep connections clean. Disconnect electric power, and then wipe the DMX and audio connections with a damp cloth. Make sure connections are thoroughly dry before linking equipment or supplying electric power.

The operator has to make sure that safety-related and machine-technical installations are to be inspected by an expert after every year in the course of an acceptance test.

The operator has to make sure that safety-related and machine-technical installations are to be inspected by a skilled person once a year.

The following points have to be considered during the inspection:

- 01) All screws used for installing the device or parts of the device have to be tightly connected and must not be corroded.
- 02) There may not be any deformations on housings, fixations and installation spots.
- 03) Mechanically moving parts like axles, eyes and others may not show any traces of wearing.
- 04) The electric power supply cables must not show any damages or material fatigue.

Troubleshooting

No Light

This troubleshooting guide is meant to help solve simple problems.

If a problem occurs, carry out the steps below in sequence until a solution is found. Once the unit operates properly, do not carry out following steps.

If the light effect does not operate properly, refer servicing to a technician.

Suspect four potential problem areas as: factory reset, the power supply, the LEDs, the internal fuse.

- 01) First try to reset the device to its original factory default settings
(**15. Reset Factory Settings** see page 25).
- 02) Power supply. Check that the unit is plugged into an appropriate power supply.
- 03) The LEDs. Return the Cyclorama to your Infinity dealer.
- 04) The internal fuse. Return the Cyclorama to your Infinity dealer.
- 05) If all of the above appears to be O.K., plug the unit in again.
- 06) If you are unable to determine the cause of the problem, do not open the Cyclorama, as this may damage the unit and the warranty will become void.
- 07) Return the device to your Infinity dealer.

No Response to DMX

Suspect the DMX cable or connectors, a controller malfunction, a light effect DMX card malfunction.

- 01) Check the DMX setting. Make sure that DMX addresses are correct.
- 02) Check the DMX cable: Unplug the unit; change the DMX cable; then reconnect to electrical power. Try your DMX control again.
- 03) Determine whether the controller or light effect is at fault. Does the controller operate properly with other DMX products ? If not, take the controller in for repair. If so, take the DMX cable and the light effect to a qualified technician.

Problem	Probable cause(s)	Remedy
One or more fixtures do not function at all	No power to the fixture	<ul style="list-style-type: none"> • Check if power is switched on and cables are plugged in
	Internal fuse blown	<ul style="list-style-type: none"> • Return the Infinity to your Infinity dealer
Fixtures reset correctly, but all respond erratically or not at all to the controller	The controller is not connected	<ul style="list-style-type: none"> • Connect controller
	3-pin/5-pin XLR Out of the controller does not match XLR Out of the first fixture on the link (i.e. signal is reversed)	<ul style="list-style-type: none"> • Install a phase reversing cable between the controller and the first fixture on the link
Fixtures reset correctly, but some respond erratically or not at all to the controller	Poor data quality	<ul style="list-style-type: none"> • Check data quality. If much lower than 100 percent, the problem may be a bad data link connection, poor quality or broken cables, missing termination plug, or a defective fixture disturbing the link
	Bad data link connection	<ul style="list-style-type: none"> • Inspect connections and cables. Correct poor connections. Repair or replace damaged cables
	Data link not terminated with 120 Ohm termination plug	<ul style="list-style-type: none"> • Insert termination plug in output jack of the last fixture on the link
	Incorrect addressing of the fixtures	<ul style="list-style-type: none"> • Check address setting
	One of the fixtures is defective and disturbs data transmission on the link	<ul style="list-style-type: none"> • Bypass one fixture at a time until normal operation is regained: unplug both connectors and connect them directly together • Have the defective fixture serviced by a qualified technician
	3-pin XLR Out on the fixtures does not match (pins 2 and 3 reversed)	<ul style="list-style-type: none"> • Install a phase-reversing cable between the fixtures or swap pin 2 and 3 in the fixture that behaves erratically
No light or LEDs cut out intermittently	Fixture is too hot	<ul style="list-style-type: none"> • Allow fixture to cool • Clean fan • Make sure air vents are not blocked • Turn up the air conditioning
	LEDs damaged	<ul style="list-style-type: none"> • Disconnect fixture and return to your dealer
	The power supply settings do not match local AC voltage and frequency	<ul style="list-style-type: none"> • Disconnect fixture. Check settings and correct if necessary

Product Specifications

Model:	Infinity TCYC-7 Cyclorama
Input Voltage:	100-240V AC, 50/60Hz
Power consumption:	310W
Power factor:	0,96
DMX linking:	30pcs
Dimensions:	566 x 195 x 257 mm (LxWxH) excl. bracket
Weight:	11,2 kg
Operating and Programming:	
Signal pin OUT:	Pin 1 (earth), pin 2 (-), pin 3 (+)
DMX Mode:	1, 6, 7, 11, 11, 11 or 21 channels
Signal input:	5-pin XLR IN
Signal output:	5-pin XLR OUT
Electro-mechanical effects:	
Light source:	300W Lumiled 7-color LED
Light output:	6000lm
CRI:	Consistently > 96% (High CRI Mode)
Color Temperature:	2000K-8000K
Beam angle:	asymmetric 75°
Tilt adjustment:	30° manual and motorized
Dimmer:	0-100%
Strobe:	0-20Hz
Dimming Curves:	Linear, Gamma 2.0, Gamma 2.2, S-curve
Housing:	Aluminum, sheet metal, molded engineering grade plastics
Color:	Black
IP rating:	IP20, indoor use only
DMX control:	via standard DMX/RDM controller
Onboard:	LC-display
Control:	DMX-512, Manual control
Connections:	Neutrik PowerCON IN/OUT, Neutrik 5-pin XLR data IN/OUT
Color wheel simulating 64 matching spectrum filter gels	
LED Color Linearity Compensation	
LED Color Temperature Drift Compensation (on all LEDs)	
Optics Color Shift compensation	
HSI, CMY & RGB Color control	
16 Bit Intelligent high resolution virtual dimming	
Tungsten mode, Color drift & timing simulation of tungsten light source	
Flicker-Free with selectable PWM via DMX	
RDM allowing for remote setting and recall of information (temperature and identity)	
Power factor: 0,96	
Max. ambient temperature (operating) t_a :	0°-40°C
Startup temperature:	-10°-45°C
Max. housing temperature t_b :	80°C
Minimum distance:	
Minimum distance from flammable surfaces:	0,5 m
Minimum distance to lighted object:	1,5 m

Design and product specifications are subject to change without prior notice.



Website: www.Showtec.info
 Email: service@highlite.com

Dimensions

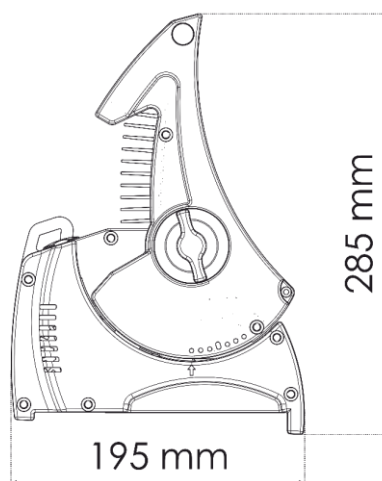
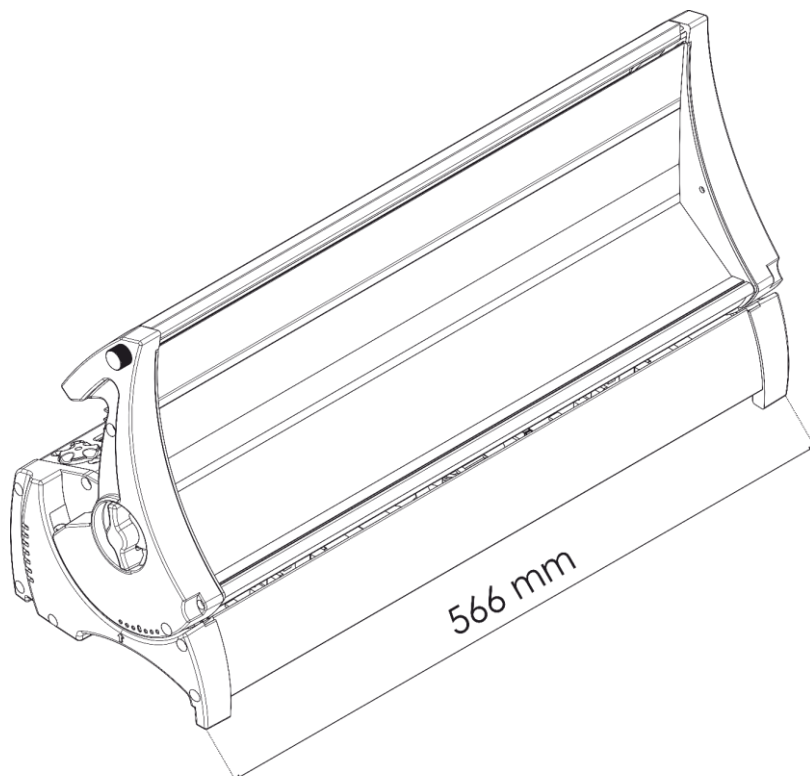



©2019 Infinity