

ENGLISH

Infinity S401 Spot

V1

Ordercode: 41506

Table of contents

Warning	3
Safety Instructions	3
Operating Determinations	5
Rigging	5
Connection with the mains.....	6
Return Procedure.....	7
Claims.....	7
Description of the device	8
Output.....	8
Electrical	8
Control	8
Optical system.....	8
Movement.....	8
Gobos & Colors	8
Physical	8
Certification and Safety	9
Frontside.....	9
Backside	10
Installation	10
Lock/Unlock the Moving Head	10
Set Up and Operation	11
Control Modes.....	11
One Infinity (Stand-alone)	11
One Infinity (Manual)	11
Multiple Infinities (DMX control)	12
Multiple Infinities (Wireless DMX Control)	13
Connect the Infinity to the Wireless DMX Signal Transmitter	14
Disconnect the Infinity from the Wireless DMX Signal Transmitter	14
Multiple Infinities (ArtNet Control)	15
Connecting to a Network	16
ArtNet Settings.....	16
How to Make a Data Cable	17
Software for controlling	17
Fixture Linking.....	18
Data Cabling.....	18
Control Panel.....	19
Control Mode	19
DMX Addressing	19
Menu Overview	20
Start-Up	24
Safety Lock.....	24
No Reset Start-Up.....	24
Main Menu Options	25
1. DMX Addressing.....	25
2. Control Mode	26
2.1. User Personality	26
3. Settings Menu	27
3.1. Network Settings	29
3.2. Lock Code	30
3.3. Touch Calibration	31
3.4. Service Menu.....	31
3.5. Reset Function.....	32
4. Manual Control	33
5. Stand-Alone	34

6. Information.....34
6.1. Fixture Information.....35
6.2. Fan Information.....35
6.3. Error Information35
6.4. Channel Information.....36
DMX Channels37
37 channels.....41
26 channels.....46

Maintenance50
Replacing the Fuse50
Gobo Size50
Replacing a Gobo From the Rotating Gobo Wheel51
Glass Gobo Orientation.....52

Rotating and Static Gobo Wheel, Color Wheel and Animation Wheel.....53

Troubleshooting54
No Light54
No Response to DMX.....54

Product Specifications56

Dimensions.....57

Moving Head Position / DMX Values58

Warning

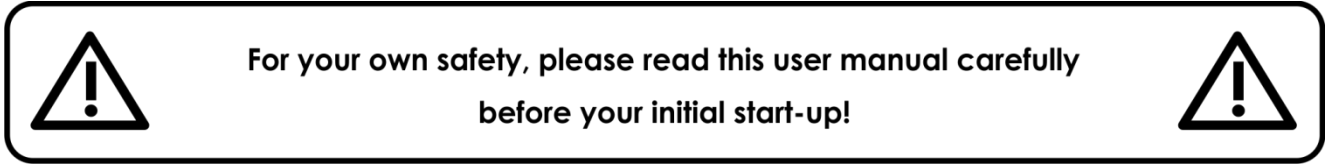

Unpacking Instructions

Immediately upon receiving this product, carefully unpack the carton and check the contents to ensure that all parts are present, and have been received in good condition. Notify the dealer immediately and retain packing material for inspection if any parts appear damaged from shipping or the carton itself shows signs of mishandling. Save the carton and all packing materials. In the event that a fixture must be returned to the factory, it is important that the fixture be returned in the original factory box and packing.

Your shipment includes:

- Infinity S401 Spot
- 2 x mounting bracket with quick-locks
- Neutrik PowerCON True1 power cable 1,5 m
- User manual

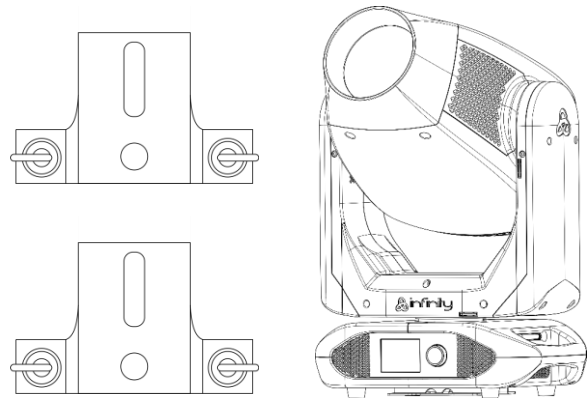

LED Expected Lifespan

LEDs gradually decline in brightness over time. HEAT is the dominant factor that leads to the acceleration of this decline. Packaged in clusters, LEDs exhibit higher operating temperatures than in ideal or singular optimum conditions. For this reason, when all color LEDs are used at their fullest intensity, life of the LEDs is significantly reduced. If improving life expectancy is of higher priority, place care in providing for lower operational temperatures. This may include climatic-environmental and the reduction of overall projection intensity.

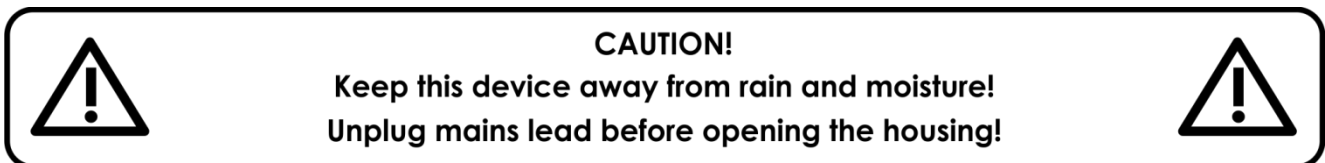

Safety Instructions

Every person involved with the installation, operation and maintenance of this device has to:

- be qualified
- follow the instructions of this manual

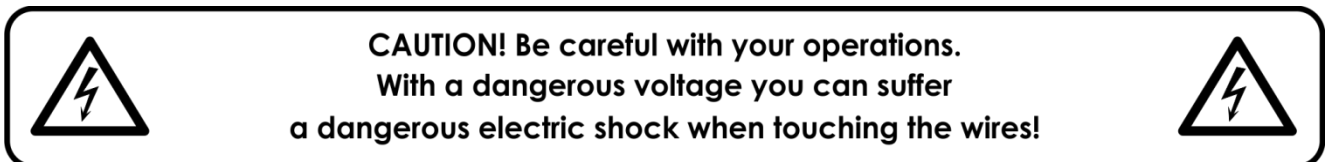

Before the initial start-up, please make sure that there is no damage caused by transportation. Should there be any, consult your dealer and do not use the device.

To maintain perfect condition and to ensure a safe operation, it is absolutely necessary for the user to follow the safety instructions and warning notes written in this manual.

Please consider that damages caused by manual modifications to the device are not subject to warranty.

This device contains no user-serviceable parts. Refer servicing to qualified technicians only.

IMPORTANT:

The manufacturer will not accept liability for any resulting damages caused by the non-observance of this manual or any unauthorized modification to the device.

- Never let the power cord come into contact with other cables! Handle the power cord and all connections with the mains with particular caution!
- Never remove warning or informative labels from the unit.
- Never use anything to cover the ground contact.
- Never lift the fixture holding it by the projector-head, as the mechanics may be damaged. Always hold the fixture by the transport handles.
- Never place any material over the lens.
- Never look directly into the light source.
- Never leave any cables lying around.
- Never loosen the screws of the rotating gobo otherwise you risk opening of the ball bearing.
- Do not insert objects into air vents.
- Do not connect this device to a dimmer pack.
- Do not switch the device on and off in short intervals, as this will reduce the device's life.
- Do not touch the device's housing bare-handed during its operation (housing becomes hot). Allow the fixture to cool for at least 5 minutes before handling.
- Do not shake the device. Avoid brute force when installing or operating the device.
- Only use the device indoors, avoid contact with water or other liquids.
- Only operate the fixture after having checked if the housing is firmly closed and all screws are tightly fastened.
- Only operate the device after having familiarized with its functions.
- Avoid flames and do not put close to flammable liquids or gases.
- Always keep the case closed while operating.
- Always allow a free air space of at least 50 cm around the unit for ventilation.
- Always disconnect power from the mains, when device is not used or before cleaning! Only handle the power cord holding it by the plug. Never pull out the plug by tugging the power cord.
- Make sure that the device is not exposed to extreme heat, moisture or dust.
- Make sure that the available voltage is not higher than stated on the rear panel.
- Make sure that the power cord is never crimped or damaged. Check the device and the power cord from time to time.
- If the lens is obviously damaged, it has to be replaced.
- If device was dropped or struck, disconnect mains power supply immediately. Have a qualified engineer inspect for safety before operating.
- If the device has been exposed to drastic temperature fluctuation (e.g. after transportation), do not switch it on immediately. The arising condensation water might damage your device. Leave the device switched off until it has reached room temperature.
- If your Infinity device fails to work properly, discontinue the use immediately. Pack the unit securely (preferably in the original packing material), and return it to your Infinity dealer for service.
- For adult use only. Moving head must be installed beyond the reach of children. Never leave the unit running unattended.
- Never attempt to bypass the thermostatic switch or fuses.
- For replacement use fuses of same type and rating only.
- The user is responsible for correct positioning and operating of the Infinity. The manufacturer will not accept liability for damages caused by the misuse or incorrect installation of this device.
- This device falls under protection class I. Therefore it is essential to connect the yellow/green conductor to earth.
- Repairs, servicing and electric connection must be carried out by a qualified technician.
- **WARRANTY:** Till one year after date of purchase.



CAUTION! Eyedamages!!!
Avoid looking directly into the lightsource!!!
(meant especially for epileptics)!!!



Operating Determinations

- This device is not designed for permanent operation. Consistent operation breaks will ensure that the device will serve you for a long time without defects.
- In order to eliminate wear and improve the device's lifespan, during periods of non-use, completely disconnect from power source via breaker or by unplugging.
- The maximum ambient temperature $t_a = 40^\circ\text{C}$ must never be exceeded.
- The relative humidity must not exceed 50 % with an ambient temperature of 40°C .
- If this device is operated in any other way than the one described in this manual, the product may suffer damages and the warranty becomes void.
- Any other operation may lead to dangers like short-circuit, burns, electric shock, crash etc.

You endanger your own safety and the safety of others!

Rigging

Please follow the European and national guidelines concerning rigging, trussing and all other safety issues.

Do not attempt the installation yourself!

Always have the inspections carried out by an authorized dealer!

Procedure:

- If the Infinity is lowered from the ceiling or high joists, professional trussing systems have to be used.
- Use a clamp to mount the Infinity, with the mounting bracket, to the trussing system.
- The Infinity must never be fixed swinging freely in the room.
- The installation must always be secured with a safety attachment, e.g. an appropriate safety net or safety cable.
- When rigging, derigging or servicing the Infinity, always make sure, that the area below the installation site is secured and that there are not any unauthorized people around.

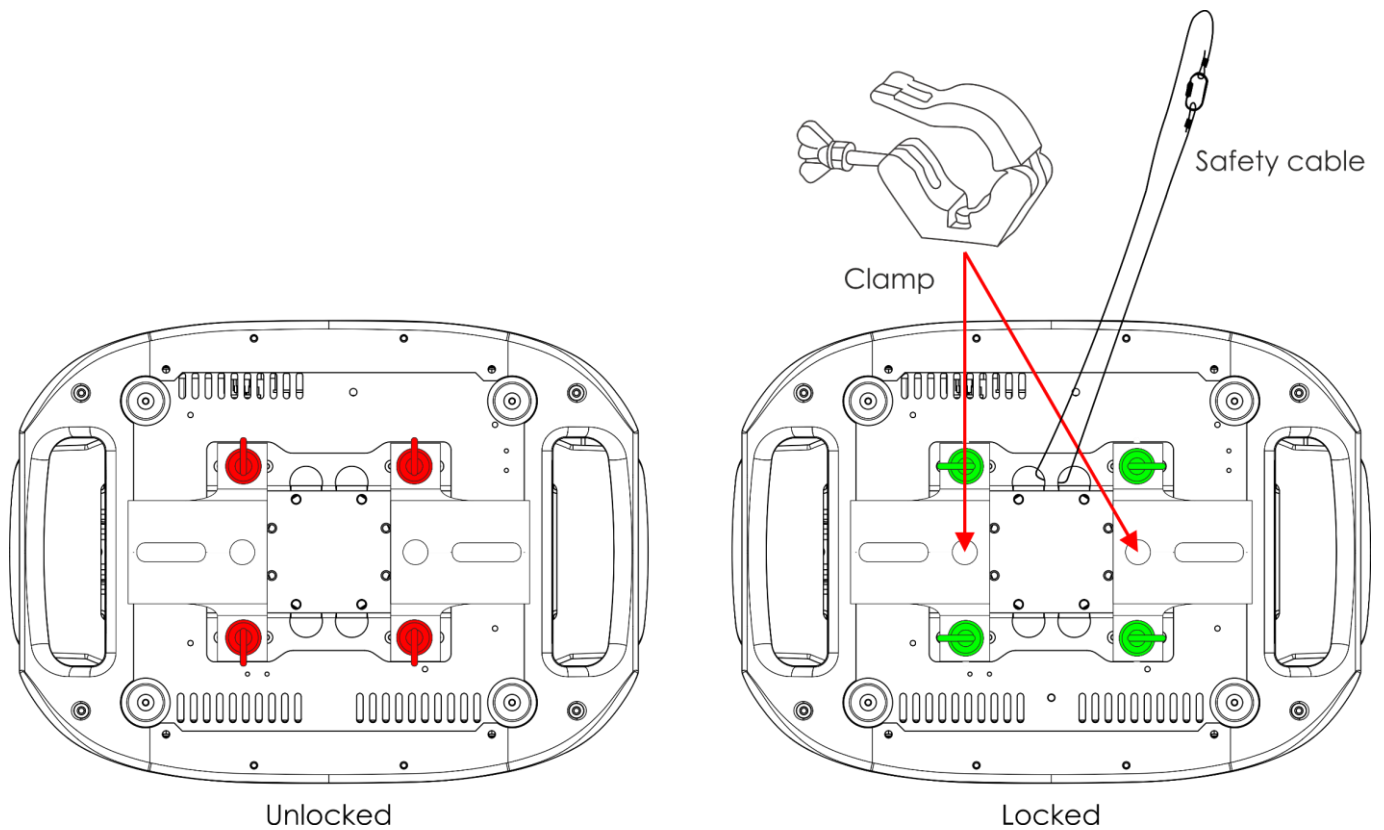

The Infinity can be placed on a flat stage floor or mounted to any kind of truss with a mounting bracket and a clamp.

Improper installation can cause serious injuries and/or damage of property!

Connection with the mains

Connect the device to the mains with the power-plug.
Always check if the right color cable is connected to the right place.

International	EU Cable	UK Cable	US Cable	Pin
L	BROWN	RED	YELLOW/COPPER	PHASE
N	BLUE	BLACK	SILVER	NEUTRAL
⊕	YELLOW/GREEN	GREEN	GREEN	PROTECTIVE GROUND

Make sure that the device is always properly connected to the earth!

Improper installation can cause serious injuries and/or damage of property!



Return Procedure



Returned merchandise must be sent prepaid and in the original packing, call tags will not be issued. Package must be clearly labeled with a Return Authorization Number (RMA number). Products returned without an RMA number will be refused. Highlite will not accept the returned goods or any responsibility. Call Highlite 0031-455667723 or mail aftersales@highlite.com and request an RMA prior to shipping the fixture. Be prepared to provide the model number, serial number and a brief description of the cause for the return. Be sure to properly pack fixture, any shipping damage resulting from inadequate packaging is the customer's responsibility. Highlite reserves the right to use its own discretion to repair or replace product(s). As a suggestion, proper UPS packing or double-boxing is always a safe method to use.

Note: If you are given an RMA number, please include the following information on a piece of paper inside the box:

- 01) Your name
- 02) Your address
- 03) Your phone number
- 04) A brief description of the symptoms

Claims

The client has the obligation to check the delivered goods immediately upon delivery for any short-comings and/or visible defects, or perform this check after our announcement that the goods are at their disposal. Damage incurred in shipping is the responsibility of the shipper; therefore the damage must be reported to the carrier upon receipt of merchandise.

It is the customer's responsibility to notify and submit claims with the shipper in the event that a fixture is damaged due to shipping. Transportation damage has to be reported to us within one day after receipt of the delivery.

Any return shipment has to be made post-paid at all times. Return shipments must be accompanied with a letter defining the reason for return shipment. Non-prepaid return shipments will be refused, unless otherwise agreed in writing.

Complaints against us must be made known in writing or by fax within 10 working days after receipt of the invoice. After this period complaints will not be handled anymore.

Complaints will only then be considered if the client has so far complied with all parts of the agreement, regardless of the agreement of which the obligation is resulting.

Description of the device

Features

The Infinity S401 Spot is a moving head with high output and great effects.

Output

- Lux @ 5m 6°: 34442
- Lux @ 5m 30°: 2205
- Beam angle: 6° - 30°
- Light source: 1 x 350W White LED
- Color temperature: 7500K

Electrical

- Input voltage: 100-240V AC, 50/60Hz
- Power consumption: 610W max. at full output

Control

- Onboard: Battery-powered, fixture-orientated touch display
- Control modes: Stand-Alone, Manual, DMX-512, W-DMX, ArtNet
- Control protocol: DMX, W-DMX, RDM, sACN, ArtNet
- DMX channels: Basic (26 channels), Advance (37 channels), User (up to 37 channels)
- Wireless DMX: Wireless Solutions Sweden

Optical system

- Dimmer: 16 bit, 0-100%
- Strobe: 0-20Hz
- Selectable PWM: 0,6/1,5/2/4/6/15 kHz
- Focus: Motorized auto focus
- Iris: Motorized, 0-100%
- Zoom: 8 or 16 bit (motorized)
- Prisms: 3-facet circular prism & 5-facet linear rotating prism
- Frost filter: Yes
- Animation: Continuously bi-rotating flame wheel & digital motion FX

Movement

- Pan: 540°
- Tilt: 270°
- Pan/Tilt resolution: 16 bit
- Special: Fixture-orientated auto pan invert

Gobos & Colors

- Rotating gobo wheel: 6 glass gobos + open
- Static gobo wheel: 7 metal gobos + open
- Gobo size: Glass gobo: **25,9** mm (gobo size); **22,94** mm (image diameter); **1,1** mm (gobo thickness)
- Gobo functions: Gobo-flow effect, Gobo shake
- Gobo rotation: Bi-directional
- Gobo index: 8 or 16 bit
- Color wheel: 7 dichroic filters + white
- CMY: 0-100%
- CTO: 0-100%
- Color functions: Split colors, Rainbow-flow effect, CMY macros

Physical

- Color: Black
- Housing: Metal & flame-retardant plastic
- Data connection: 5-pin Neutrik XLR & RJ-45 IN/OUT
- Power connection: Neutrik PowerCON True1 IN/OUT
- Fuse: F12AL/250V
- Dimensions: 385 x 284 x 680 mm (LxWxH)
- Weight: 28,9 kg

Certification and Safety

- Certification: CE
- Max. ambient temperature: 40°C

Optional accessories:

[Z0454](#) – Safety cable Saveling 4 mm (Natural)

[Z0456](#) – Safety cable Saveling 4 mm (Black)

[FLA43](#) – DMX Terminator

[Z5101](#) – Fast Coupler 150 kg (Black)

Frontside

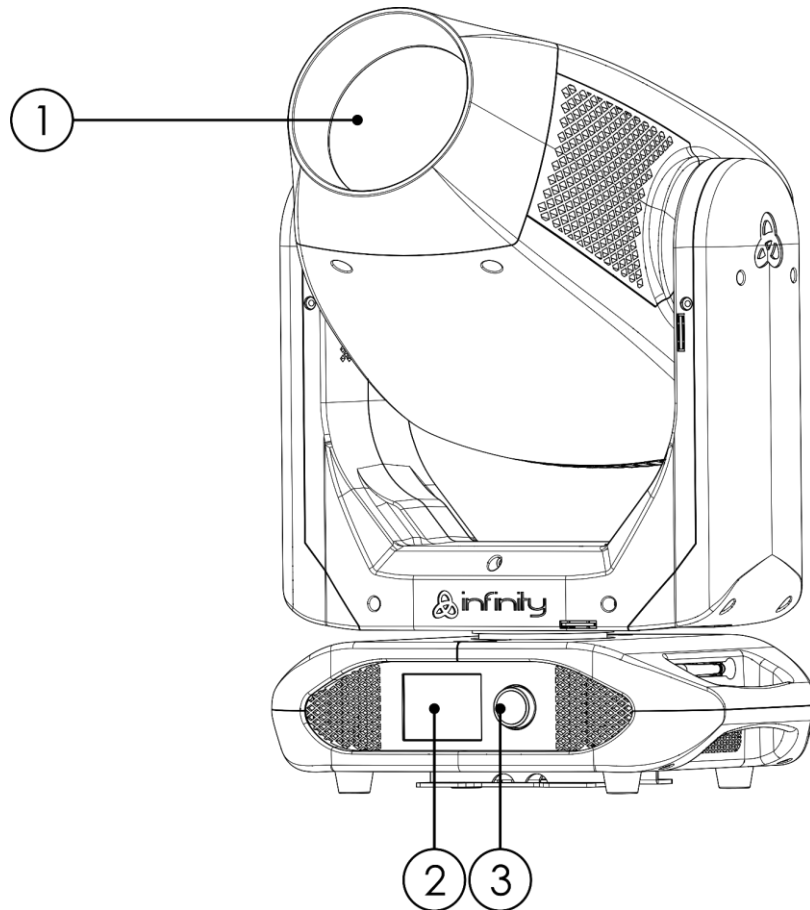

Fig. 01

- 01) Lens
- 02) LCD display
- 03) Menu control

Backside

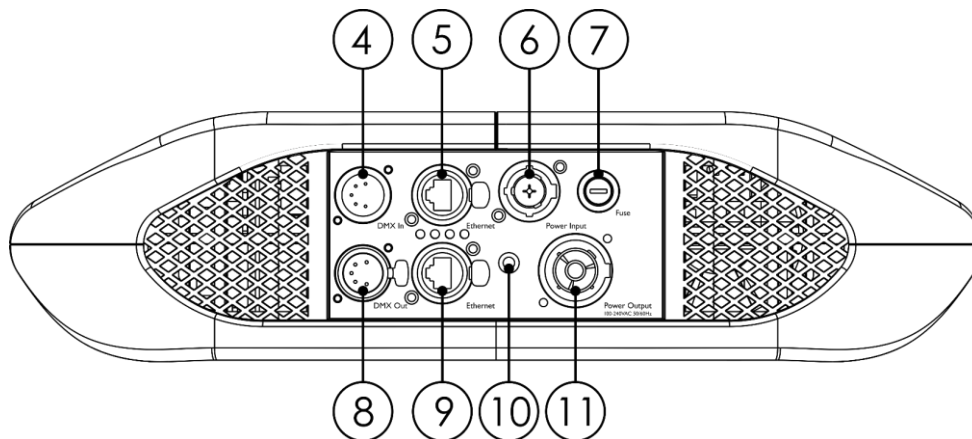

Fig. 02

- 04) 5-pin DMX signal connector IN
- 05) RJ45 ArtNet connector
- 06) Neutrik PowerCON True1 power connector IN
- 07) Fuse F12AL/250V
- 08) 5-pin DMX signal connector OUT
- 09) RJ45 ArtNet connector
- 10) Ground/earth connection
- 11) Neutrik PowerCON True1 power connector IN

Installation

Remove all packing materials from the Infinity S401 Spot. Check if all foam and plastic padding is removed. Connect all cables.

Do not supply power before the whole system is set up and connected properly.
Always disconnect from electric mains power supply before cleaning or servicing.
Damages caused by non-observance are not subject to warranty.

Lock/Unlock the Moving Head

You can **lock** the moving head by sliding the lock pin to the left (horizontally) for **Pan** or upwards (vertically) for **Tilt (Red arrows)**. You can **unlock** the moving head by sliding the lock pin to the right (horizontally) for **Pan** or downwards (vertically) for **Tilt (Green arrows)**.

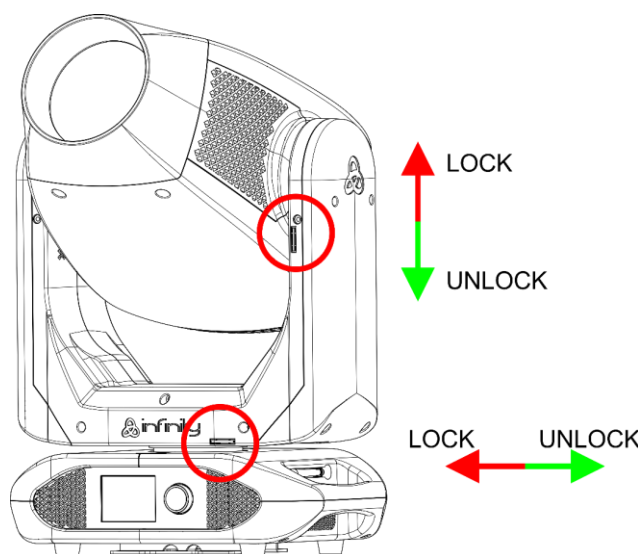

Fig. 03

Set Up and Operation

Follow the directions below, as they pertain to your preferred operation mode.

Before plugging the unit in, always make sure that the power supply matches the product specification voltage. Do not attempt to operate a 120V specification product on 230V power, or vice versa. Connect the device to the main power supply.

Control Modes

There are 5 modes:

- Stand-alone
- Manual
- DMX-512 (26CH, 37CH)
- W-DMX (26CH, 37CH)
- ArtNet (26CH, 37CH)

One Infinity (Stand-alone)

- 01) Fasten the effect light to a firm trussing. Leave at least 0,5 meter on all sides for air circulation.
- 02) Always use a safety cable (ordercode 70140 / 70141).
- 03) Plug the end of the electric mains power cord into a proper electric power supply socket.
- 04) When the Infinity is not connected with a DMX cable, it functions as a stand-alone device.
- 05) Please see page 34 for more information about Stand-alone mode.

One Infinity (Manual)

- 01) Fasten the effect light to a firm trussing. Leave at least 0,5 meter on all sides for air circulation.
- 02) Always use a safety cable (ordercode 70140 / 70141).
- 03) Plug the end of the electric mains power cord into a proper electric power supply socket.
- 04) When the Infinity is not connected with a DMX cable, it functions as a stand-alone device.
- 05) Please see page 33 for more information about Manual mode.

Multiple Infinitys (DMX control)

- 01) Fasten the effect light to a firm trussing. Leave at least 0,5 meter on all sides for air circulation.
- 02) Always use a safety cable (ordercode 70140 / 70141).
- 03) Use a 5-pin XLR cable to connect the Infinity and other devices.

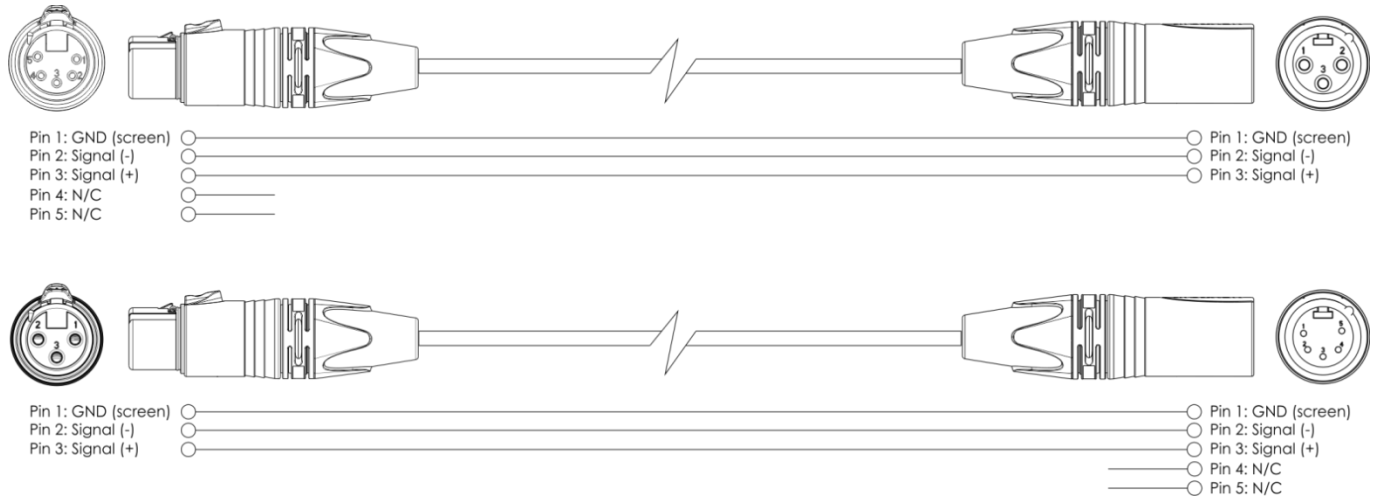

- 04) Link the units as shown in fig. 04. Connect the first unit's DMX "out" socket with the second unit's "in" socket, using a DMX signal cable. Repeat this process to link the second, third, and fourth units.
- 05) Supply electric power: Plug electric mains power cords into each unit's PowerCON True1 socket, then plug the other end of the mains power cord into proper electric power supply sockets, starting with the first unit. Do not supply power before the whole system is set up and connected properly.

Multiple Infinitys DMX Set Up

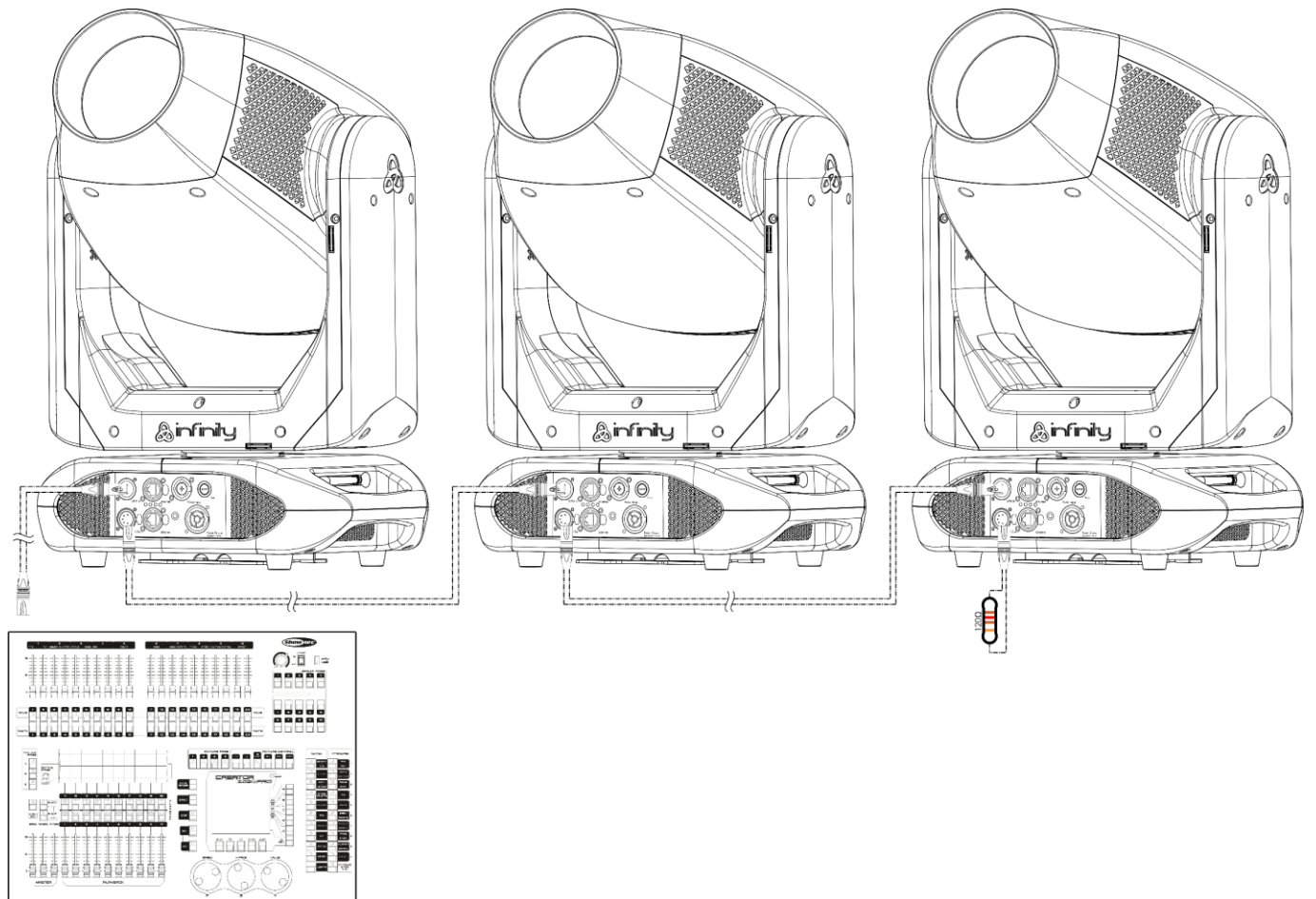



Fig. 04

Note : Link all cables before connecting electric power

Multiple Infinities (Wireless DMX Control)

- 01) Install multiple Infinities at the desired positions (maximum Wi-Fi distance: 250 m).
- 02) In order for the Infinities to receive a wireless DMX signal properly, activate W-DMX on all Infinities (see page 28 for more information).
- 03) Pair the wireless signal transmitter with multiple Infinities. In order to create a wireless connection, please read the manual of your wireless signal transmitter.
- 04) When the green W-DMX indicator  on the display is blinking, the device is searching for a connection.
- 05) Once a connection has been established, the W-DMX indicator  will stop blinking and will light up green.
- 06) Use a DMX cable to connect the transmitter to a suitable light controller.

Multiple Infinities Wireless DMX Control

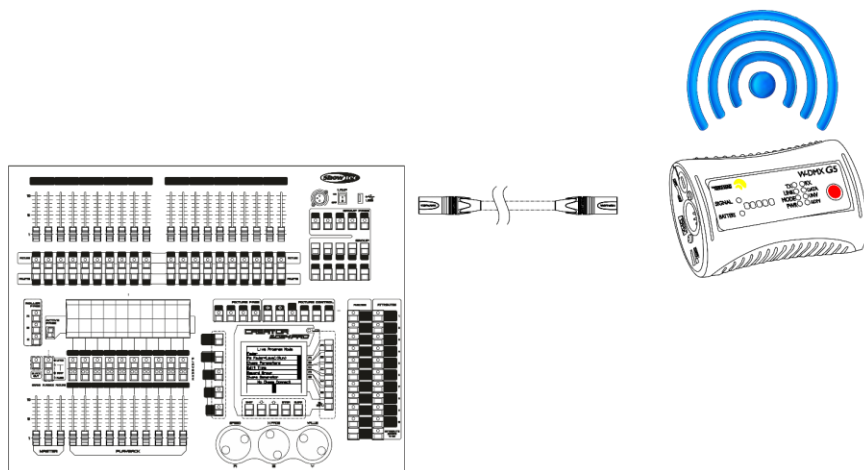

Use the Wireless DMX MicroBox F-1 G5 Transceiver (50175).

Fig. 05

Sweden 2.4GHz Wireless communication module

Communication distance:	Depending on the transmitting power or transmitter module
Test conditions:	W-DMX TRx Transmitter module, 2dBi Antenna, transmitting power 20dBm (100mW)
Range indoor:	60 m (approx. through three concrete walls)
Range outdoor:	250 m

Wireless DMX Connection

The wireless receiving module "Pico G4 Receiver, 2.4GHz", provided by Swedish WIRELESS SOLUTION, only has a 2.4 GHz wireless signal receiving function. In order to match the wireless signal, please use the [50175](#) W-DMX MicroBox F-1 G5 Transceiver by WIRELESS SOLUTION. To control the status of the wireless communication, please look at the blue LED indicator on the bottom of the fixture.

Wi-Fi Problems:

01) No connection with a transmitter.

The W-DMX indicator  on the display will be gray.

02) Searching for a connection.

The W-DMX indicator  on the display will be blinking quickly.

When the wireless DMX communication is normal, the W-DMX indicator  on the display is always green.



The Infinity cannot receive a wireless DMX signal and a DMX cable signal at the same time.



Connect the Infinity to the Wireless DMX Signal Transmitter

The Infinity cannot actively match a random wireless signal transmitter.

In order to create a wireless match, please check the manual of your wireless signal transmitter.

We advise you to use the W-DMX MicroBox F-1 G5 Transceiver ([50175](#)) by WIRELESS SOLUTION (Fig. 06).

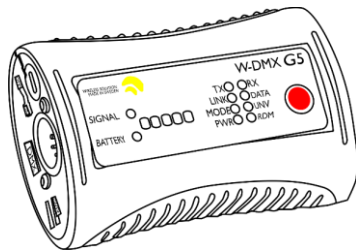

Fig. 06

Disconnect the Infinity from the Wireless DMX Signal Transmitter

01) Turn off/unlink the W-DMX. In order to do so, deactivate W-DMX (see page 28 for more information).

02) Unlink the Infinity (see page 28 for more information).

03) The Infinity will now be disconnected.

Multiple Infinitys (ArtNet Control)

- 01) Fasten the effect light to a firm trussing. Leave at least 0,5 meter on all sides for air circulation.
- 02) Always use a safety cable (ordercode 70140 / 70141).
- 03) Use a CAT-5/CAT-6 cable to connect the Infinity and other devices.
- 04) Connect your PC with installed ArtNet software to the first device's RJ45 "in" socket.
- 05) Link the units as shown in fig. 07. Connect the first unit's RJ45 "out" socket with the second unit's "in" socket, using a CAT-5/CAT-6 cable. Repeat this process to link the second, third, and fourth units.
- 06) Supply electric power: Plug electric mains power cords into each unit's PowerCON True1 socket, then plug the other end of the mains power cord into proper electric power supply sockets, starting with the first unit. Do not supply power before the whole system is set up and connected properly.

Multiple Infinitys ArtNet Set Up

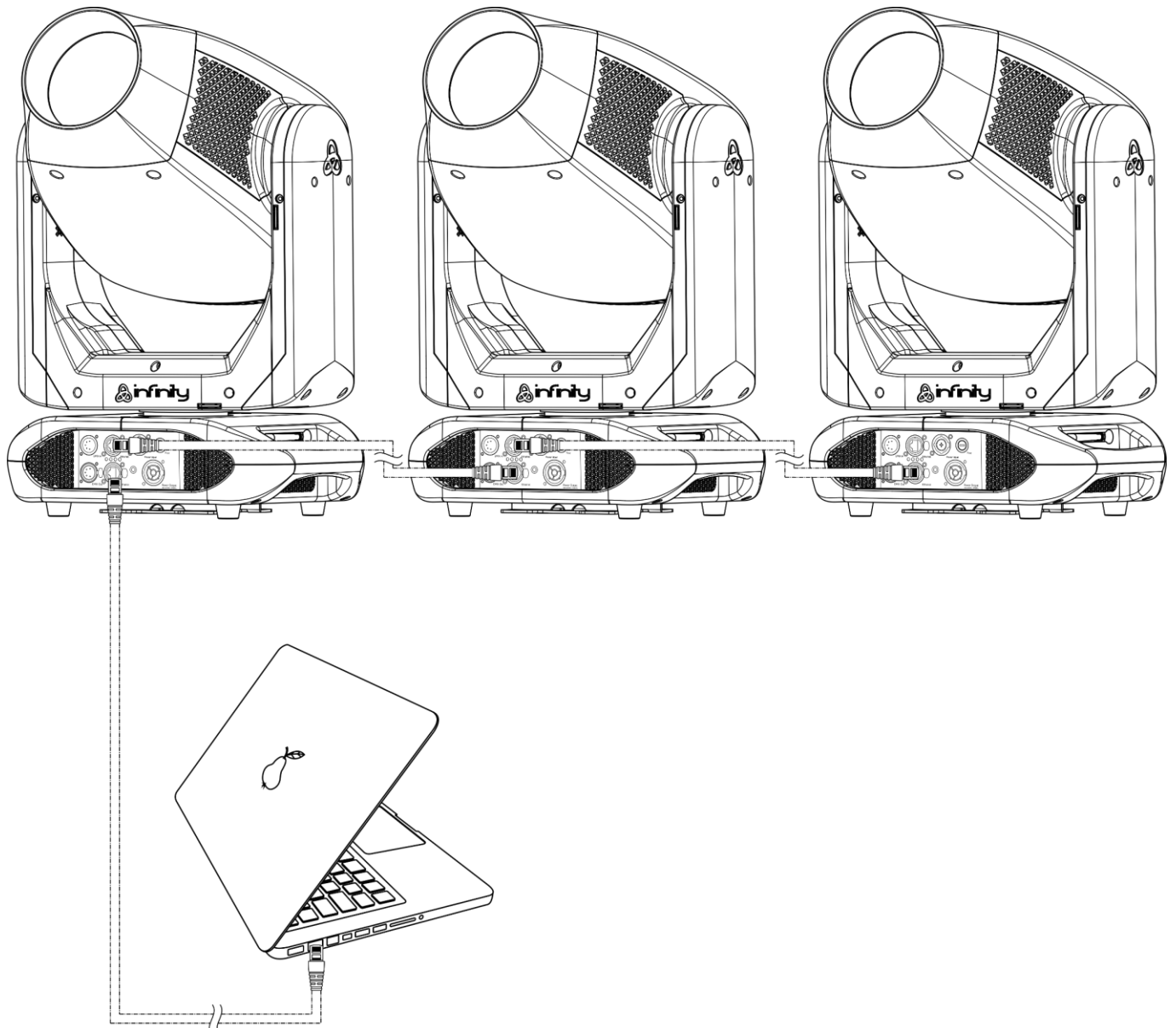

Fig. 07

Note : Link all cables before connecting electric power

Connecting to a Network

ArtNet Settings

- 01) Install any ArtNet-based software on your PC (Windows or Mac) or use a light controller which supports ArtNet.
- 02) Connect the power supply to the Infinity.
- 03) Connect the device's Ethernet connector to your software/light controller's Ethernet connector, using a CAT-5/CAT-6 cable.
- 04) Set the IP address of your software/light controller to **2.x.x.x** or **10.x.x.x**, depending on the ArtNet settings.
- 05) Set the subnet mask to **255.0.0.0** on both – the Infinity and your software/light controller. Make sure that all the fixtures in the network have a **unique IP address**.
- 06) If you want to connect more fixtures, follow the example below.

Example:

- 01) Make sure that each connected Infinity has a **unique IP address**.
- 02) Make sure that the subnet mask on each device is set to **255.0.0.0**.
- 03) Set the universe of the first Infinity to **1**.
- 04) Set the first Infinity's DMX address to **001**.
- 05) Please note, that you can connect only 13 devices (13 x 37 channels = 481 channels needed). Due to the channel limit of 512, you cannot connect the 14th device to the same data line, as it would result in limited functionality of the 14th device.
- 06) In order to solve this problem, set the universe of the 14th S401 to **2** and its DMX address to **001**.
- 07) When connecting multiple devices, you can repeat steps 5 and 6 up to 255 times, each time inserting ascending universe numbers (as there are 255 universes available).
- 08) Using your software (for example 50224 - Arkaos Media Master Express), map all the connected devices, using the settings described above.
- 09) The Infinity S401's are now ready for use.
- 10) When creating large setups, it is recommended to use a 16-bit, high speed ethernet switch to distribute the ArtNet data signal.

How to Make a Data Cable

A standard ETHERNET cable can be used to replace the data cable required to transmit the data for the S401 Spot.

Please follow the instructions below in order to create an extra net cable.

Take a standard net cable (CAT-5/ 5E /6) and connect it to the RJ45 connector, as shown in the picture below (Fig. 08). The wires should now be colored as follows:

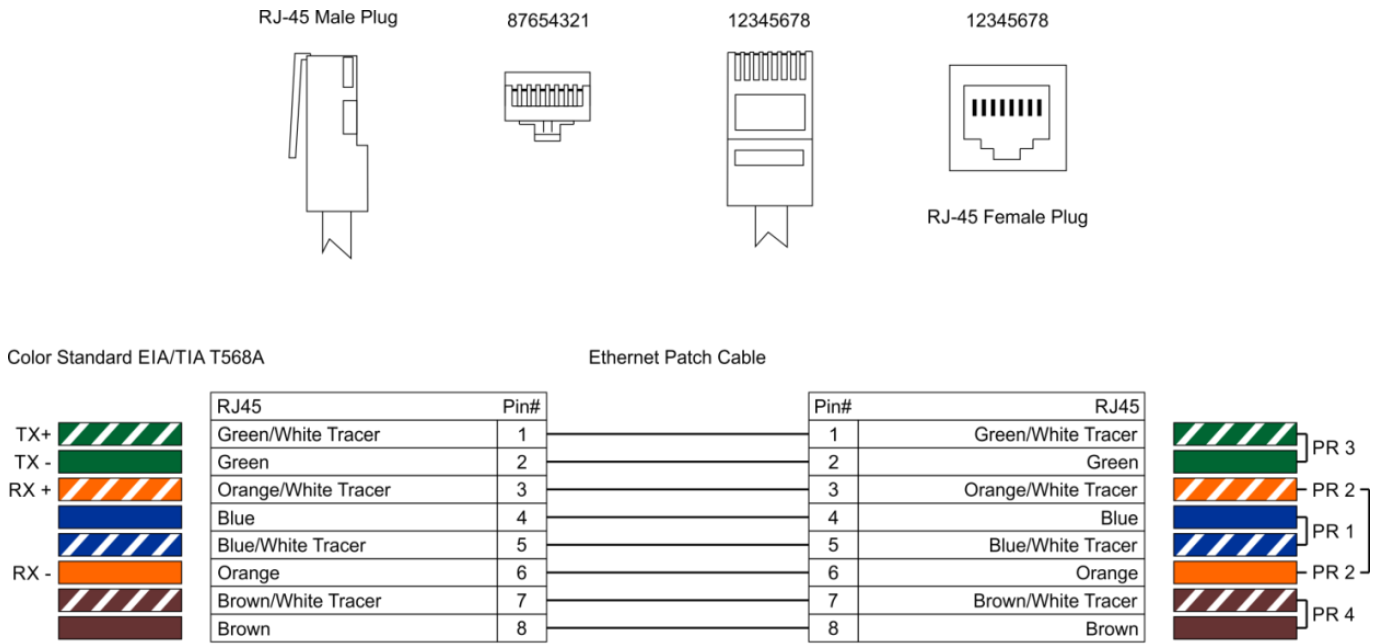

Fig. 08

Software for controlling

Connect all the devices and run your software.

[50224](#)

Arkaos Media Master Express

The latest update of the successful media server software.

[502267](#)

Arkaos Media Master Pro 4.0: PRO DMX video software for lighting designers.

Fixture Linking

You will need a serial data link to run light shows of one or more fixtures using a DMX-512 controller or to run synchronized shows of two or more fixtures set to a master/slave operating mode. The combined number of channels required by all the fixtures on a serial data link determines the number of fixtures the data link can support.

Important: Fixtures on a serial data link must be daisy-chained in a single line. To comply with the EIA-485 standard, no more than 30 devices should be connected on one data link. Connecting more than 30 fixtures on one serial data link without the use of a DMX optically isolated splitter may result in deterioration of the digital DMX signal.

 Maximum recommended DMX data link distance: 100 meters
 Maximum recommended number of fixtures on a DMX data link: 30 fixtures
 Maximum recommended number of fixtures on a power link @110V: 1 fixture
 Maximum recommended number of fixtures on a power link @240V: 2 fixtures

Data Cabling

To link fixtures together, you must obtain data cables. You can purchase DAP Audio certified DMX cables directly from a dealer/distributor or construct your own cable. If you choose to create your own cable, please use data-grade cables that can carry a high quality signal and are less prone to electromagnetic interference.

DAP Audio DMX Data Cables

- DAP Audio Basic microphone cable for allround use. bal. XLR/M 3-pin > XLR/F 3-pin. **Ordercode** FL01150 (1,5 m), FL013 (3 m), FL016 (6 m), FL0110 (10 m), FL0115 (15 m), FL0120 (20 m).
- DAP Audio X-type data cable XLR/M 3-pin > XLR/F 3-pin. **Ordercode** FLX0175 (0,75 m), FLX01150 (1,5 m), FLX013 (3 m), FLX016 (6 m), FLX0110 (10 m).
- DAP Audio cable for the demanding user with exceptional audio-qualities and connector made by Neutrik®. **Ordercode** FL71150 (1,5 m), FL713 (3 m), FL716 (6 m), FL7110 (10 m).
- DAP Audio cable for the demanding user with exceptional audio-qualities and connector made by Neutrik®. **Ordercode** FL7275 (0,75 m), FL72150 (1,5 m), FL723 (3 m), FL726 (6 m), FL7210 (10 m).
- DAP Audio 110 Ohm cable with digital signal transmission. **Ordercode** FL0975 (0,75 m), FL09150 (1,5 m), FL093 (3 m), FL096 (6 m), FL0910 (10 m), FL0915 (15 m), FL0920 (20 m).
- DAP Audio data cable FL08 DMX/AES-EBU, XLR/M 5-pin > XLR/F 5-pin. **Ordercode** FL08150 (1,5 m), FL083 (3 m), FL086 (6 m), FL0810 (10 m), FL0820 (20 m).
- DAP Audio DMX adapter: 5-pin/3-pin. **Ordercode** FLA29.
- DAP Audio DMX adapter: 3-pin/5-pin. **Ordercode** FLA30.
- DAP Audio DMX Terminator 3-pin. **Ordercode** FLA42.
- DAP Audio DMX Terminator 5-pin. **Ordercode** FLA43.

DAP Audio PC Interface Cables

- CAT-5 cable 7,6 mm Matte blue PVC. **Ordercode** FL55150 (1,5 m), FL553 (3 m), FL556 (6 m), FL5510 (10 m), FL5515 (15 m), FL5520 (20 m).
- CAT-6 cable (recommended for best data transfer). **Ordercode** FL563 (3 m), FL566 (6 m), FL5610 (10 m), FL5615 (15 m), FL5640 (40 m).

Control Panel

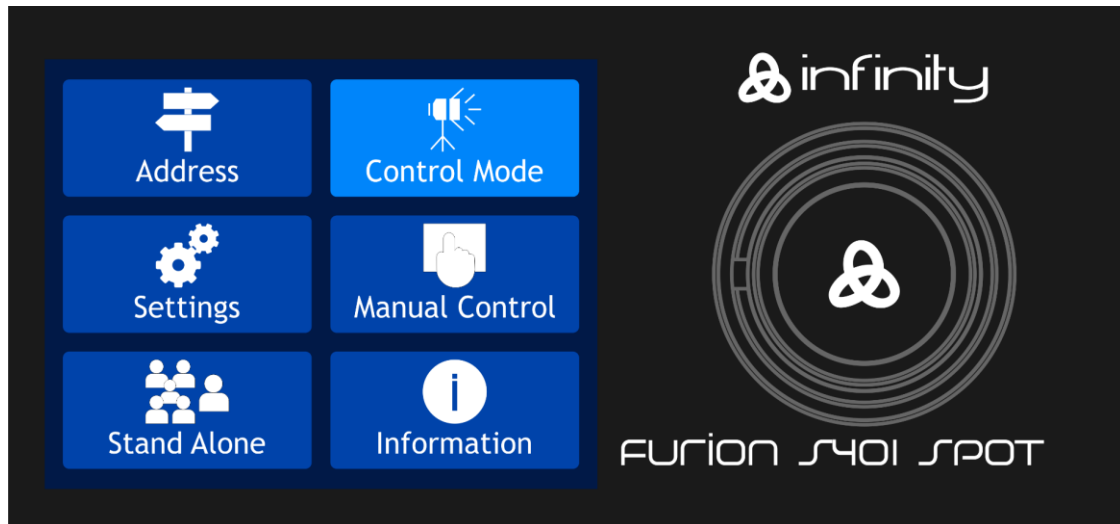

Touch the display and/or press and turn the control to navigate through the menu options.

Fig. 09

Control Mode

The fixtures are individually addressed on a data-link and connected to the controller. The fixtures respond to the DMX signal from the controller. (When you select the DMX address and save it, the controller will display the saved DMX address the next time.)

DMX Addressing

The control panel on the front side of the base allows you to assign the DMX fixture address, which is the first channel from which the Infinity will respond to the controller. Please note when you use the controller, the unit has **37** channels. When using multiple Infinities, make sure you set the DMX addresses right. Therefore, the DMX address of the first Infinity should be **1(001)**; the DMX address of the second Infinity should be **1+37=38 (038)**; the DMX address of the third Infinity should be **38+37=75 (075)**, etc. Please, be sure that you do not have any overlapping channels in order to control each Infinity correctly. If two or more Infinities are addressed similarly, they will work similarly.

Controlling:

After having addressed all Infinity fixtures, you may now start operating these via your lighting controller. **Note:** After switching on, the Infinity will automatically detect whether DMX 512 data is received or not. If there is no data received at the DMX input, the "LED" on the control panel will not flash.

The problem may be:

- The XLR cable from the controller is not connected with the input of the Infinity.
- The controller is switched off or defective, the cable or connector is defective, or the signal wires are swapped in the input connector.

Note: It is necessary to insert a XLR termination plug (with 120 Ohm) in the last fixture in order to ensure proper transmission on the DMX data link.

Display Off after 35 seconds

When the menu control or the display is not pressed for 35 seconds, the display will turn off. To light up the display, you have to press the menu control or the display as described above. Once you have pressed the menu control or the display, the display will light up.

Menu Overview

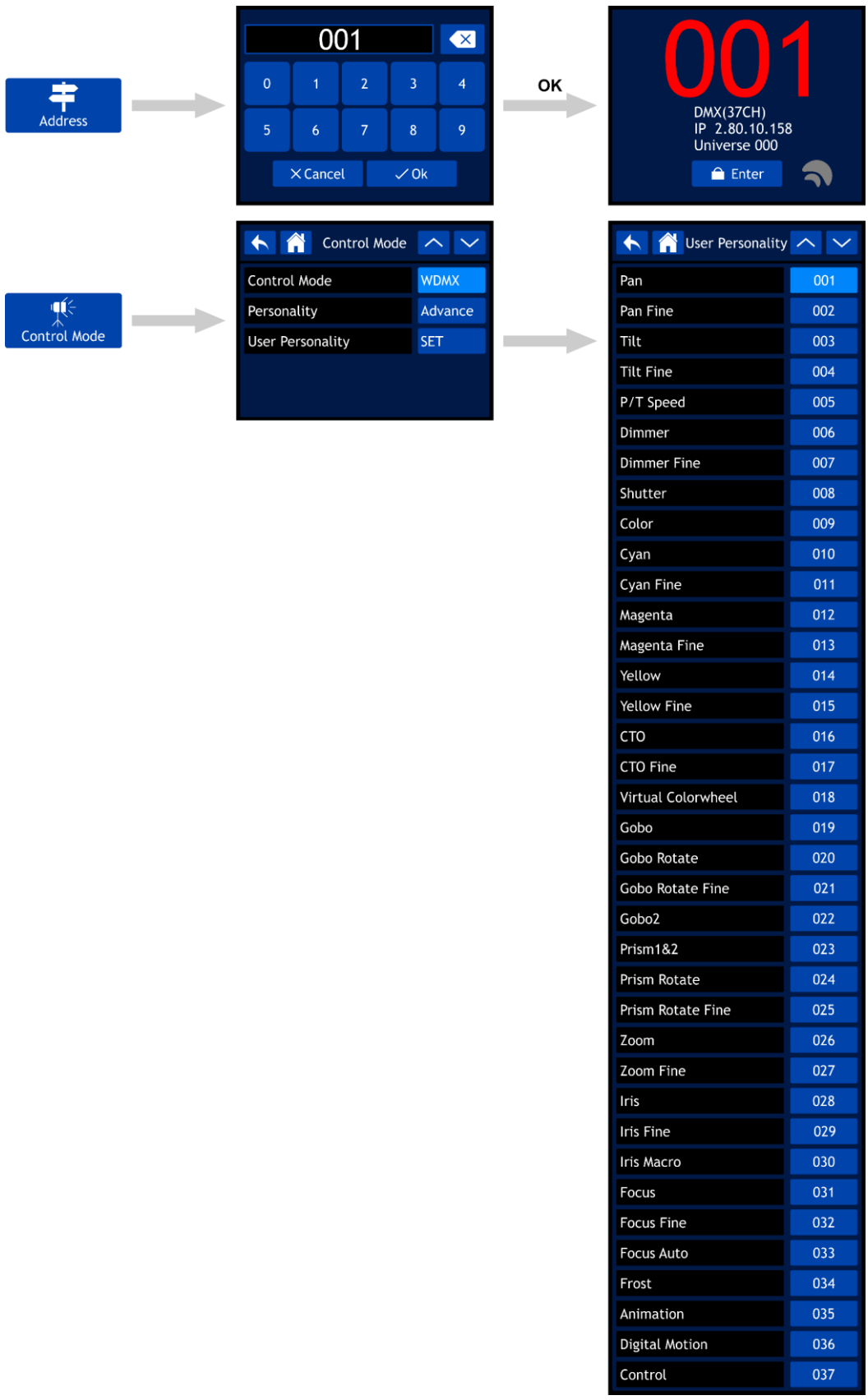



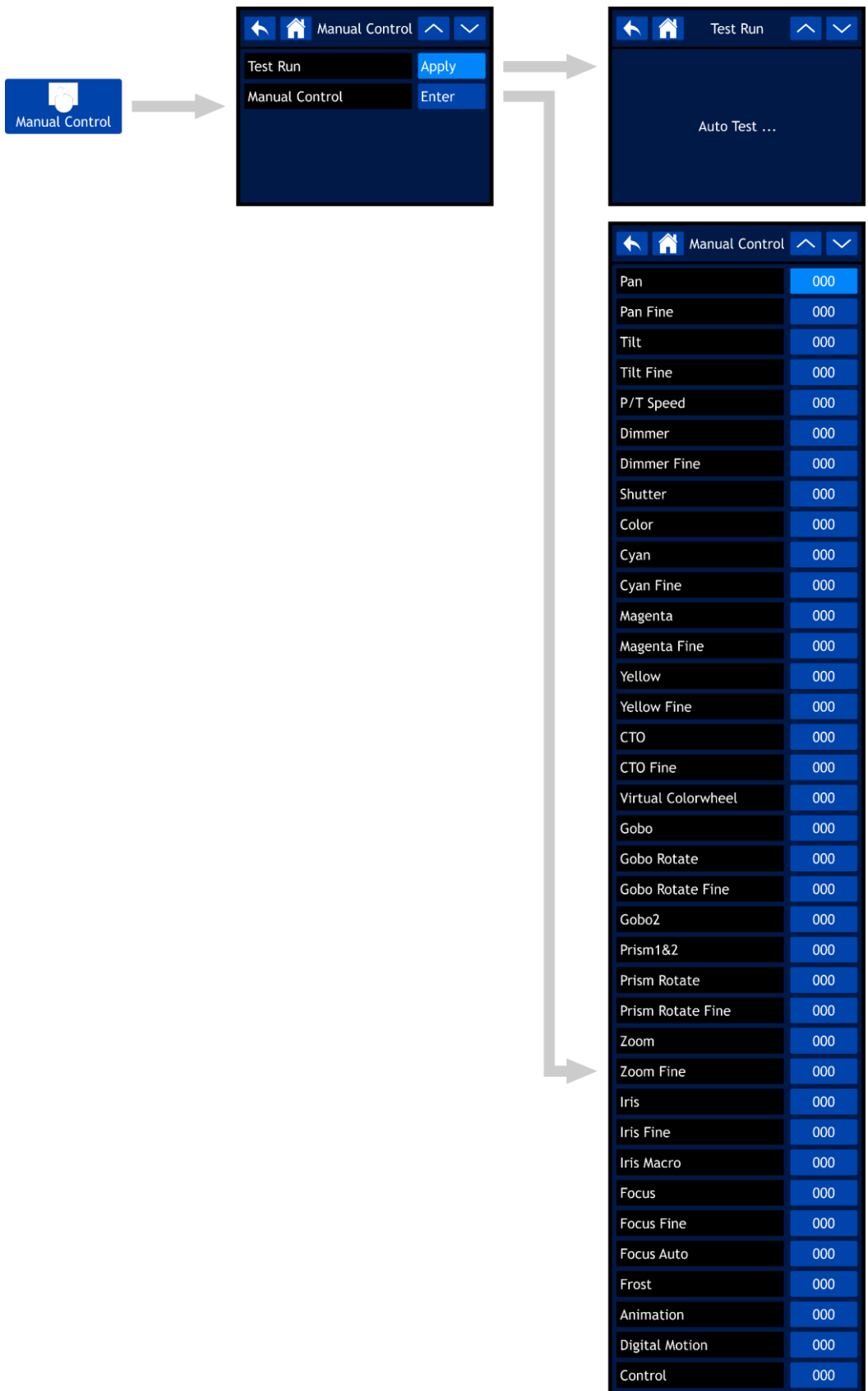

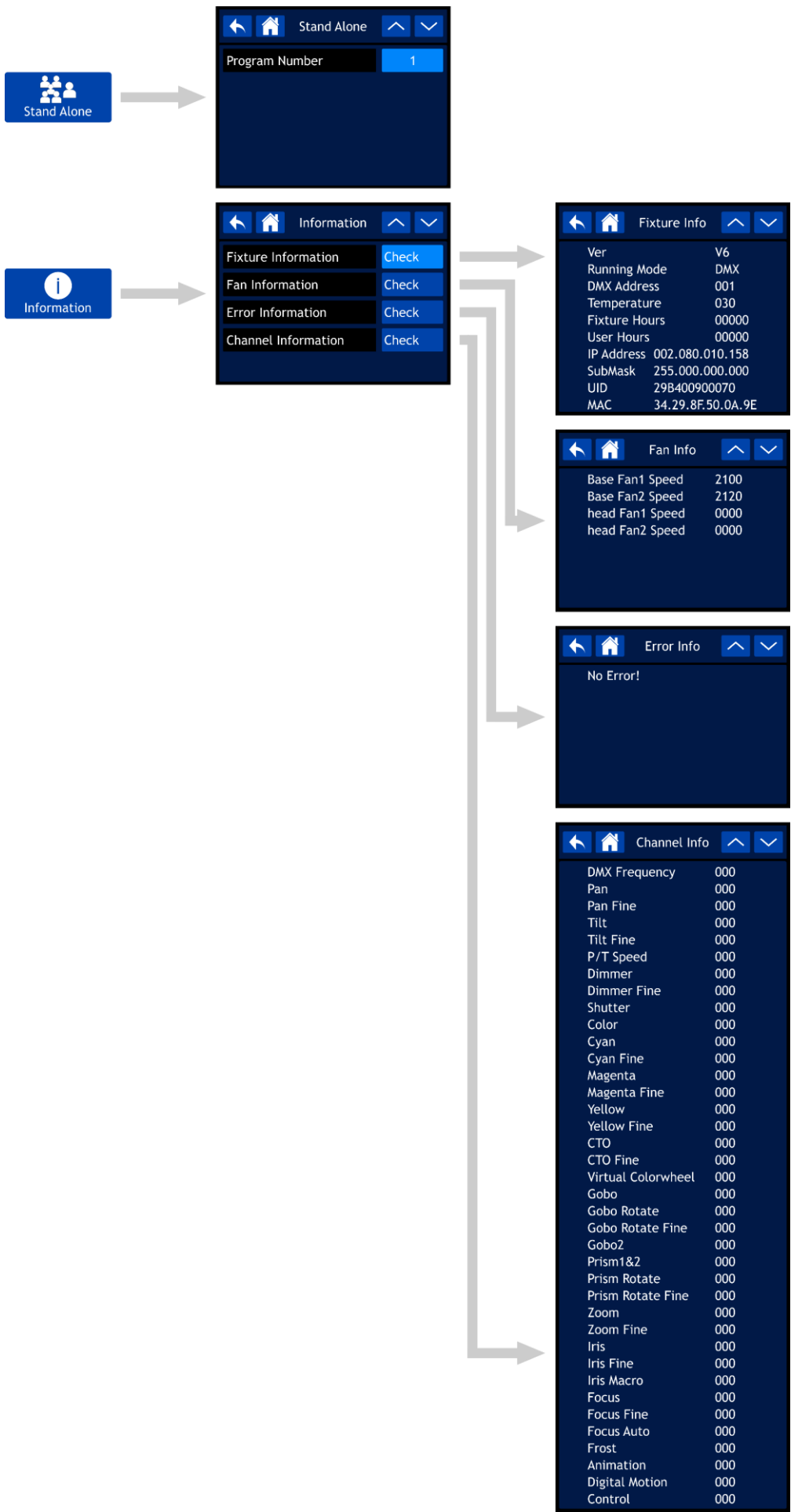

Start-Up

The display is equipped with a touch screen, which means that the options can be accessed in 2 ways:

- By turning (to select/adjust the values) and pressing the control (to confirm).
- By touching the options directly on the screen.





Please note, that some options can be accessed ONLY by turning/pressing the control and the touch screen will not work.

01) Upon start-up, the device will show the start screen:



02) You can now see the current DMX starting address, the currently selected control protocol and the channel mode.

03) If W-DMX is active, the W-DMX indicator  will appear on the screen.

- If the Infinity is not assigned to a transmitter, the  indicator will be gray.
- If the Infinity is assigned to a transmitter but DMX is not present, the  indicator will blink slowly.
- If the Infinity is assigned to a transmitter and DMX is present, the  indicator will be green.
- If the Infinity is being linked to a transmitter or lost the connection with the transmitter, the  indicator will blink quickly.

Safety Lock

01) Select ENTER on the display to gain access to the main menu.

02) If the safety lock is active (see page 30 for more information), you will need to insert the 4-digit safety code. **If the safety lock is not active, skip steps 2-4 and proceed to step 5:**

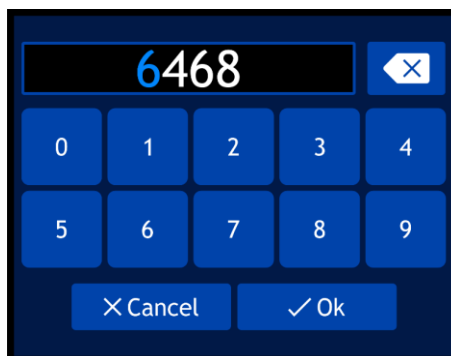

03) The universal master code is: **6468**. Type the code in using the touch screen or by turning and pressing the control. It is also possible to set up your own personal safety code (see page 30 for more information). Select OK in order to confirm the code.

04) If you wish to activate the safety lock again, press and hold down the control for 3 seconds.

05) The display will now show the main menu. Please see the next page.

No Reset Start-Up

It is not required to turn the Infinity on, in order to adjust the device's settings. It is possible to activate only the display. There are 2 possibilities:

- Press and hold down the control for 3 seconds. The Infinity will remain off and the display will be on.
- Upon power-up, press and hold down the control and, at the same time, supply power. The Infinity will start without a reset and the display will function regardless of the supplied power or the lack thereof.

Main Menu Options



DMX Addressing



Control Mode



Settings Menu



Manual Control



Stand-Alone



Information



Return one step back



Up



Home



Down

1. DMX Addressing

With this menu you can set the DMX address.

01) In main menu, select  and enter the menu. The display will show:



02) Turn the control or type in the desired DMX address. The adjustment range is between 001-512.

03) Once you have set the desired DMX address, select OK to store the settings.

2. Control Mode

With this menu you can set your desired control mode and DMX personality.



01) In main menu, select  and enter the menu. The display will show:

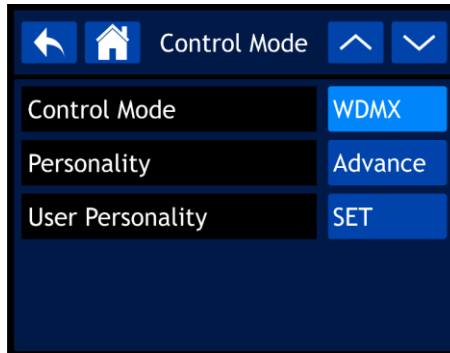

02) Select the required mode:

- CONTROL MODE: DMX, WDMX, ArtNet, sACN
- PERSONALITY: BASIC (26 channels), ADVANCE (37 channels), USER (up to 37 channels)
- USER PERSONALITY: Customize your Infinity by changing the order of the 37 DMX channels and/or leaving some channels out. Please, see below for more information.

2.1. User Personality

01) Once you have selected USER PERSONALITY, the display will show:



02) Use the control or the UP/DOWN buttons to toggle through the 37 functions. The functions correspond with the functions listed in the DMX section, 37 Channels. See page 41 for more information.

03) Press the control to confirm your choice.

04) Turn the control in order to assign a DMX channel to this function. The adjustment range is between 001-037 and NO (the function will be skipped).

05) Press the control to confirm your choice.

3. Settings Menu

With this menu you can set your desired mode.



01) In main menu, select  and enter the menu. The display will show:

Settings	
Screen Reverse	AUTO
Pan Reverse	NO
Tilt Reverse	NO
Pan Angle	540
Tilt Angle	270
Auto Pan Invert	ON
Backlight Timer	30S
Dimmer Curve	Linear
PWM Option	4000Hz
WDMX	OFF
Wireless Unlink	NO
DMX Fail	Hold
Fans	Auto
Network Settings	Enter
Lock Code	SET
Touch Calibration	SET
BL. O. P/T Move	NO
BL. O. Color Move	NO
BL. O. Gobo Move	NO
Service Menu	Enter
Reset User Hours	NO
Reset Function	Enter
Factory Settings	NO

- 02) Use the control or press the UP/DOWN buttons to toggle through the 23 submenus.
- 03) Press the control to confirm your choice.
- 04) Turn the control in order to adjust the values.
- 05) Press the control to save your settings.

06) The available submenus are:

- SCREEN REVERSE: The display will be flipped, depending on the position of the Infinity(AUTO/YES/NO)
- PAN REVERSE: NO/YES
- TILT REVERSE: NO/YES
- PAN ANGLE: 540°/360°/180°
- TILT ANGLE: 270°/180°/90°
- AUTO PAN INVERT: Pan will be flipped, depending on the position of the Infinity (ON/OFF)
- BACKLIGHT TIMER: The amount of time which needs to pass for the display to turn off (5 min./1 min./30 sec./ON)
- DIMMER CURVE: LINEAR/SCURVE/I SQUA/SQUARE

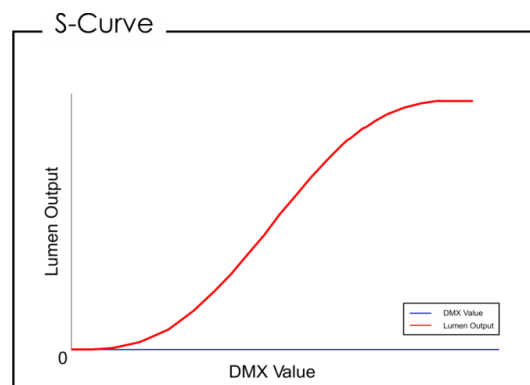
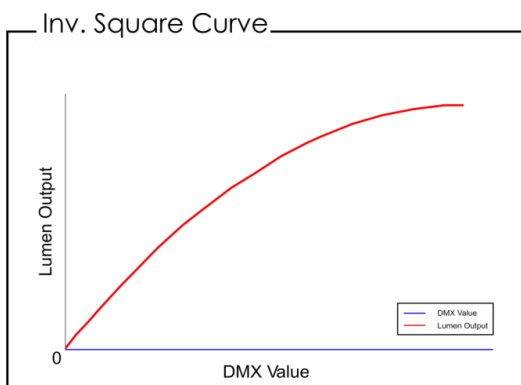
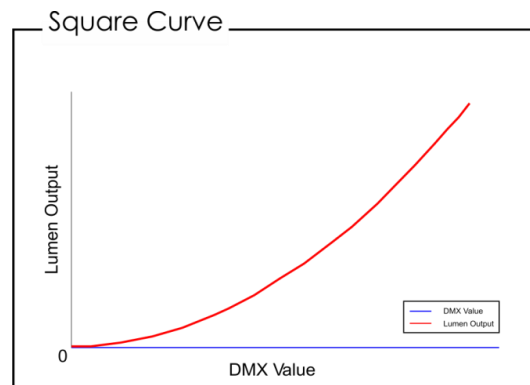
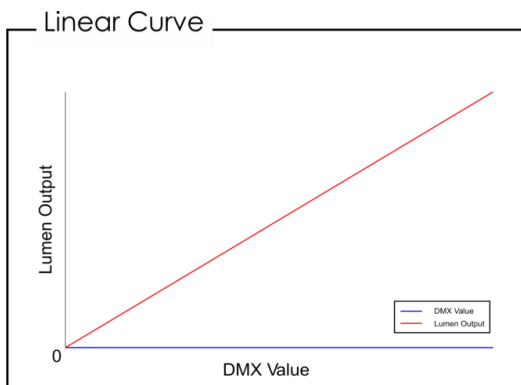

- PWM OPTION: 600Hz/1200Hz/2000Hz/4000Hz/6000Hz/15000Hz
- WDMX: Activate/deactivate Wireless DMX (ON/OFF)
- WIRELESS UNLINK: Terminate the connection between the Infinity and the transmitter (YES/NO)
- DMX FAIL: The Infinity's behavior in case of a DMX error. There are 2 options: OFF (output blackout) and HOLD (the Infinity will use the latest properly working DMX signal which ensures uninterrupted performance)
- FANS: Energy saving mode (AUTO/SILENT/FULL)
- BL. O. P/T MOVE: Output blackout when Pan/Tilt are active (YES/NO)
- BL. O. COLOR MOVE: Output blackout during the color wheel movement (YES/NO)
- BL. O. GOBO MOVE: Output blackout during the gobo wheel movement (YES/NO)
- RESET USER HOURS: Reset the total operation time counter (YES/NO)
- FACTORY SETTINGS: Restore the factory default settings (YES/NO)

07) There are also 5 submenus which offer more advanced settings than the ones listed above:

- NETWORK SETTINGS
- LOCK CODE
- TOUCH CALIBRATION
- SERVICE MENU
- RESET FUNCTION

3.1. Network Settings

With this menu you can set the network settings.

01) If you have selected NETWORK SETTINGS, the display will show:

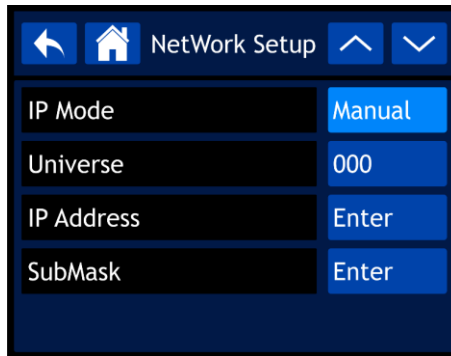

02) Use the control or the UP/DOWN buttons to toggle through the 4 submenus.

03) Once you have selected the desired submenu, press the control to confirm your choice.

04) Turn the control in order to adjust the values.

05) Press the control to save your settings.

06) The available submenus are:

- IP MODE: MANUAL/DHCP
- UNIVERSE: Set the universe (000-255)
- IP ADDRESS: Set the IP address
- SUBMASK: Set the submask

07) If you have selected one of the 3 last options (UNIVERSE, IP ADDRESS or SUBMASK), the display will show:

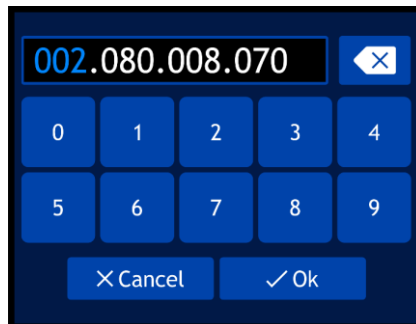

08) Turn the control in order to select/adjust the values and press the control to confirm your choice.

09) Alternatively, type the values in, using the buttons on the screen.

10) Select OK to save your settings.

3.2. Lock Code

With this menu you can set the safety code.

01) If you have selected LOCK CODE, the display will show:

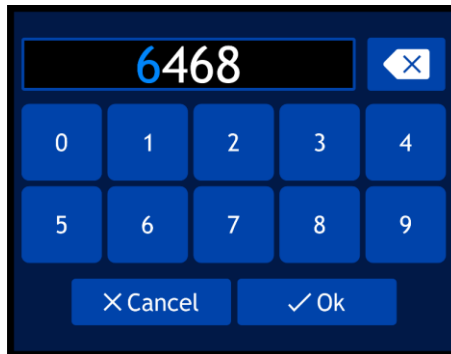

02) Turn and press the control in order to insert the **master code: 6468**.

03) Alternatively, you can type the values in, using the buttons on the screen.

04) Select OK to confirm. The display will show:

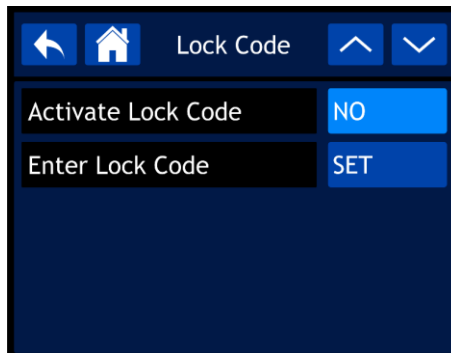

05) Use the control or the UP/DOWN buttons to toggle through the 2 submenus.

06) Once you have selected the desired submenu, press the control to confirm your choice.

07) Turn the control in order to adjust the values.

08) Press the control to save your settings.

09) The available submenus are:

- ACTIVATE LOCK CODE: YES/NO
- ENTER LOCK CODE

10) If you have selected ENTER LOCK CODE, the display will show:

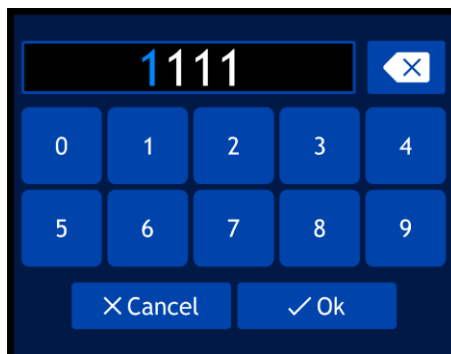

11) Turn and press the control in order to create your personal code.

12) Alternatively, you can type the values in, using the buttons on the screen.

13) Select OK to confirm. You can now use your personal code when unlocking the display.

14) If you forget your personal code, you can still insert the **master code: 6468** which overrides the personal code.

3.3. Touch Calibration

With this menu you can calibrate the touch screen.

01) If you have selected TOUCH CALIBRATION, the display will show:

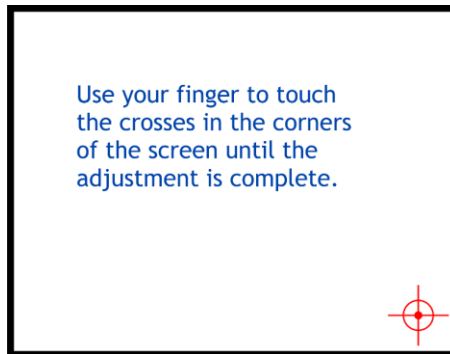

02) Follow the instructions on the display until the touch screen calibration is complete.

3.4. Service Menu

With this menu you can fine-tune various function-related discrepancies and imperfections, according to your preferences.

01) If you have selected SERVICE MENU, the display will show:

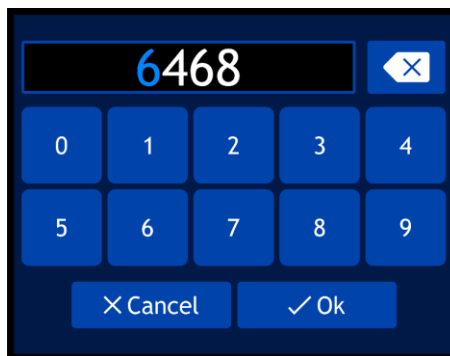

02) Turn and press the control in order to insert the **master code: 6468**.

03) Alternatively, you can type the values in, using the buttons on the screen.

04) Select OK to confirm. The display will show:



05) Use the control or the UP/DOWN buttons to toggle through the 30 functions.

06) Once you have selected the desired function, press the control to confirm your choice.

07) Turn the control in order to adjust the values.

08) Press the control to save your settings.

09) The available functions are:

- PAN
- TILT
- COLOR
- GOBO
- GOBO ROTATE

- GOBO2
- FOCUS-GOBO2
- FOCUS-GOBO
- ZOOM
- PRISM1
- PRISM2
- PRISM2 ROT
- IRIS
- FROST
- CYAN
- MAGENTA
- YELLOW
- CTO
- ANIMATION
- DIMMER1
- DIMMER2
- DIMMER3
- DIMMER4
- DIMMER5
- MAC4
- MAC5
- MAC6
- RDM ID4
- RDM ID5
- RDM ID6

3.5. Reset Function

With this menu you can reset the device's settings.

01) If you have selected RESET FUNCTION, the display will show:



02) Use the control or the UP/DOWN buttons to toggle through the 6 functions:

- PAN/TILT: Pan/Tilt reset
- IRIS/PRISM: prism reset
- COLOR/CMY: Color wheel reset
- GOBO/GOBO ROTATE: Gobo wheel reset
- FROST/ANIMATION: Frost/animation wheel reset
- ALL: Complete settings reset

03) Once you have selected the desired function, press the control to confirm your choice.

04) Turn the control in order to select YES or NO.

05) Press the control to confirm your choice.

06) If you have selected YES, the function in question will be reset.

4. Manual Control

With this menu you can set Manual mode.



01) In main menu, select **Manual Control** and enter the menu. The display will show:

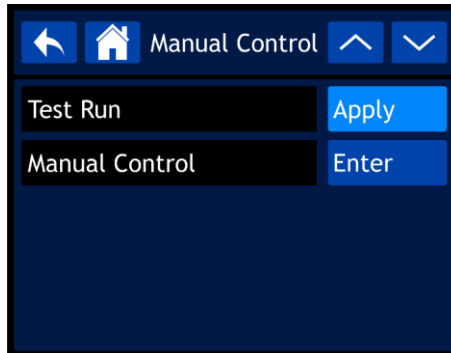

- 02) Use the control or the UP/DOWN buttons to toggle through the 2 submenus.
- 03) Once you have selected the desired submenu, press the control to confirm your choice.
- 04) Turn the control in order to adjust the values.
- 05) Press the control to save your settings.
- 06) The available submenus are:
 - TEST RUN
 - MANUAL CONTROL

07) If you have selected TEST RUN, the display will show:

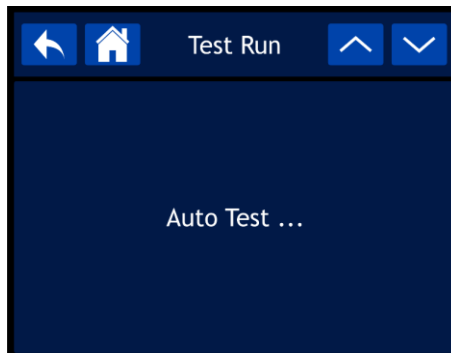

- 08) The device will now test its functions.
- 09) If you have selected MANUAL CONTROL, the display will show:



- 10) Use the control or the UP/DOWN buttons to toggle through the 37 functions. The functions correspond with the functions listed in the DMX section, 37 Channels. See page 41 for more information.
- 11) Once you have selected the desired function, press the control to confirm your choice.
- 12) Turn the control in order to adjust the values. The adjustment range is between 000-255
- 13) Press the control to save your settings.

5. Stand-Alone

With this menu you can set your desired built-in program.



01) In main menu, select  and enter the menu. The display will show:

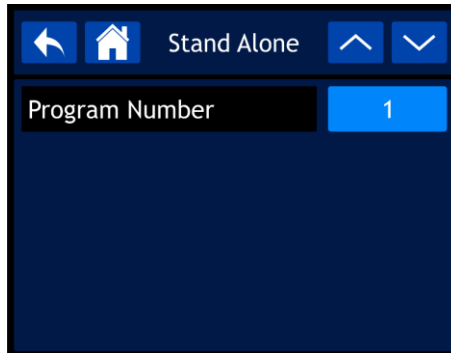

02) Press the control and then turn it in order to select one of the 9 built-in programs.

03) Press the control to confirm your choice. The device will now run the selected program.

6. Information

With this menu you can view the device's parameters.



01) In main menu, select  and enter the menu. The display will show:

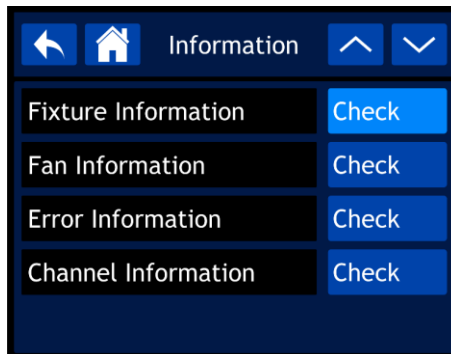

02) Use the control or the UP/DOWN buttons to toggle through the 4 submenus.

03) Once you have selected the desired submenu, press the control to confirm your choice.

04) The available submenus are:

- FIXTURE INFORMATION
- FAN INFORMATION
- ERROR INFORMATION
- CHANNEL INFORMATION

6.1. Fixture Information

With this menu you can view the currently installed software version, operation mode, DMX address and many other crucial parameters.

01) If you have selected FIXTURE INFORMATION, the display will show:



Fixture Info	
Ver	V6
Running Mode	DMX
DMX Address	001
Temperature	030
Fixture Hours	00000
User Hours	00000
IP Address	002.080.010.158
SubMask	255.000.000.000
UID	29B400900070
MAC	34.29.8F.50.0A.9E

02) Use the control or the UP/DOWN buttons to toggle through 2 screens, in order to see all pieces of information.

6.2. Fan Information

With this menu you can view the status of the fans.

01) If you have selected FAN INFORMATION, the display will show:

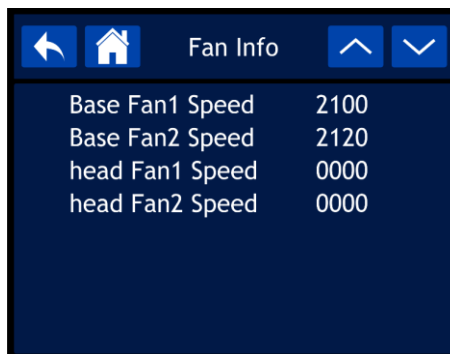

Fan Info	
Base Fan1 Speed	2100
Base Fan2 Speed	2120
head Fan1 Speed	0000
head Fan2 Speed	0000

6.3. Error Information

With this menu you can view any present errors.

01) If you have selected ERROR INFORMATION, the display will show:

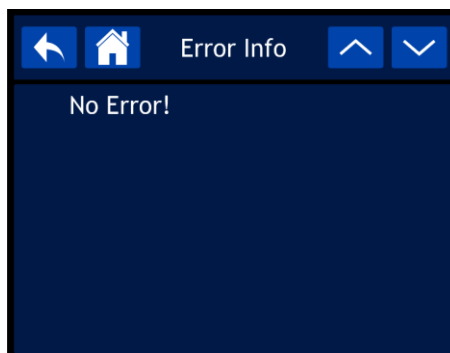

Error Info	
No Error!	

6.4. Channel Information

With this menu you can view all the channel information.

01) If you have selected CHANNEL INFORMATION, the display will show:

Channel Info	
DMX Frequency	000
Pan	000
Pan Fine	000
Tilt	000
Tilt Fine	000
P/T Speed	000
Dimmer	000
Dimmer Fine	000
Shutter	000
Color	000
Cyan	000
Cyan Fine	000
Magenta	000
Magenta Fine	000
Yellow	000
Yellow Fine	000
CTO	000
CTO Fine	000
Virtual Colorwheel	000
Gobo	000
Gobo Rotate	000
Gobo Rotate Fine	000
Gobo2	000
Prism1&2	000
Prism Rotate	000
Prism Rotate Fine	000
Zoom	000
Zoom Fine	000
Iris	000
Iris Fine	000
Iris Macro	000
Focus	000
Focus Fine	000
Focus Auto	000
Frost	000
Animation	000
Digital Motion	000
Control	000

02) Use the control or the UP/DOWN buttons to toggle through 2 screens, in order to see all pieces of information.

DMX Channels

Infinity Furion S401			Firmware Version V6.0				
Basic	Advanced	Function	DMX		Default	Highlight	Snap
1	1	Pan	0-255	0-540	128		
2	2	Pan 16bit	0-255	16bit adjustable			
3	3	Tilt	0-255	0-270	128		
4	4	Tilt 16bit	0-255	16bit adjustable			
	5	Pan/tilt speed	0-255	decreasing speed	0		
5	6	Dimmer	0-255	0-100%	0	255	
	7	Dimmer 16bit	0-255	16bit adjustable			
6	8	Strobe	0-3 4-7 8-76 77-145 146-215 216-255	Close Open Synchronized strobe, increasing speed Pulse strobe, increasing speed Random strobe, increasing speed On	6	6	
7	9	Color wheel	0-6 7-13 14-20 21-27 28-34 35-41 42-48 49-59 60-187 188-219 220-223 224-255	Open Color 1 (Red) Color 2 (Light Pink) Color 3 (Amber) Color 4 (Dark Lavender) Color 5 (Primary Green) Color 6 (Aquamarine) Color 7 (Congo Blue) Split color Negative scroll, decreasing speed Stop Positive scroll, increasing speed	0	0	yes
8	10	Cyan	0-255	0-100%	0	0	
	11	Cyan 16bit	0-255	16bit adjustable			
9	12	Magenta	0-255	0-100%	0	0	
	13	Magenta 16bit	0-255	16bit adjustable			
10	14	Yellow	0-255	0-100%	0	0	
	15	Yellow 16bit	0-255	16bit adjustable			
11	16	CTO	0-255	0-100%	0	0	
	17	CTO 16bit	0-255	16bit adjustable			
12	18	CMY macro	0-9 10-127 128-255	No function CMY color CMY macro, decreasing speed	0	0	

Infinity Furion S401			Firmware Version V6.0				
Basic	Advanced	Function	DMX		Default	Highlight	Snap
13	19	Rotating gobo wheel	0-8 9-17 18-26 27-35 36-44 45-53 54-63 64-73 74-82 83-91 92-100 101-109 110-118 119-127 128-190 191-192 193-255	Open Gobo 1 (Asteroids) Gobo 2 (Psycho) Gobo 3 (Brushed) Gobo 4 (Triangles) Gobo 5 (Baroque) Gobo 6 (Spiral) Gobo 6 shaking, increasing speed Gobo 5 shaking, increasing speed Gobo 4 shaking, increasing speed Gobo 3 shaking, increasing speed Gobo 2 shaking, increasing speed Gobo 1 shaking, increasing speed Open Positive scroll, decreasing speed Stop Negative scroll, increasing speed	0	0	yes
14	20	Gobo rotating	0-45 46-126 127-130 131-211 212-255	Gobo index Positive rotating, decreasing speed Stop Negative rotating, increasing speed Rotating back and forth	128		
	21	Gobo rotating 16bit	0-255	16bit adjustable index			
15	22	Static gobo wheel	0-6 7-13 14-20 21-27 28-34 35-41 42-48 49-63 64-70 71-77 78-84 85-91 92-98 99-105 106-112 113-127 128-190 191-192 193-255	Open Gobo 1 (Circle) Gobo 2 (Radial Lines) Gobo 3 (Spokes) Gobo 4 (Twist) Gobo 5 (Organic) Gobo 6 (Digi Blocks) Gobo 7 (Vector) Gobo 7 shaking, increasing speed Gobo 6 shaking, increasing speed Gobo 5 shaking, increasing speed Gobo 4 shaking, increasing speed Gobo 3 shaking, increasing speed Gobo 2 shaking, increasing speed Gobo 1 shaking, increasing speed Open Positive scroll, decreasing speed Stop Negative scroll, increasing speed	0		yes

Infinity Furion S401				Firmware Version V6.0			
Basic	Advanced	Function	DMX		Default	Highlight	Snap
16	23	Prism	0-4 5-127 128-255	No function Prism 1 effect (3-facet Circular) Prism 2 effect (5-facet Linear)	0		yes
17	24	Prism rotating	0-45 46-126 127-130 131-211 212-255	Prism index Positive rotating, decreasing speed Stop Negative rotating, increasing speed Rotating, back and forth	128		
	25	Prism rotating 16bit	0-255	16bit adjustable			
18	26	Zoom	0-255	Big to small	128		
	27	Zoom 16bit	0-255	16bit adjustable			
19	28	Iris	0-255	Big to small	0		
	29	Iris 16bit	0-255	16bit adjustable			
20	30	Iris macro	0-63 64-127 128-191 192-255	No function Auto change, increasing speed Slow zoom out, fast zoom in, increasing speed Slow zoom in, fast zoom out, increasing speed	0		
21	31	Focus	0-255	0-100%	128		
	32	Focus 16bit	0-255	16bit adjustable			
22	33	Auto focus	0 1-11 12-22 23-33 34-44 45-55 56-66 67-77 78-88 89-99 100-110 111-127 128-138 139-149 150-160 161-171 172-182 183-193 194-204 205-215 216-226 227-237 238-255	No function 0-5 meters, auto focus-gobo 1 6 meters, auto focus-gobo 1 7 meters, auto focus-gobo 1 8 meters, auto focus-gobo 1 9 meters, auto focus-gobo 1 10 meters, auto focus-gobo 1 12.5 meters, auto focus-gobo 1 15 meters, auto focus-gobo 1 17.5 meters, auto focus-gobo 1 20-60 meters, auto focus-gobo 1 auto detect distance-gobo1 0-5 meters, auto focus-gobo 2 6 meters, auto focus-gobo 2 7 meters, auto focus-gobo 2 8 meters, auto focus-gobo 2 9 meters, auto focus-gobo 2 10 meters, auto focus-gobo 2 12.5 meters, auto focus-gobo 2 15 meters, auto focus-gobo 2 17.5 meters, auto focus-gobo 2 20-60 meters, auto focus-gobo 2 auto detect distance-gobo 2	0		

Infinity Furion S401				Firmware Version V6.0			
Basic	Advanced	Function	DMX		Default	Highlight	Snap
23	34	Frost	0-255	0-100%	0		
24	35	Animation Wheel	0-1 2-126 127-130 131-255	No function Positive rotating, decreasing speed Stop Negative rotating, increasing speed	0		
25	36	Digital motion FX	0-1 2-128 129-255	No function Step mode, increasing speed Fade mode, increasing speed	0		
26	37	Functions	0-5 6-11 12-17 18-23 24-29 30-35 36-41 42-47 48-53 54-59 60-65 66-71 72-77 78-83 84-89 90-95 96-101 102-107 108-113 114-119 120-125 126-131 132-137 138-143 144-149 150-155 156-161 162-167 168-173 174-179 180-185 186-191 192-203 204-209 210-215 216-255	No function Pan Reverse Pan Normal Tilt Reverse Tilt Normal Pan Tilt Swop Pan Tilt Normal BO PT on BO PT off BO Color on BO Color off BO Gobo on BO Gobo off Fans Auto Fans Full Fans Silent DMX Fail: Hold DMX Fail: Off Dimmer Linear Dimmer Square Dimmer I-Square Dimmer - Scurve PWM 600Hz PWM 1200Hz PWM 2000Hz PWM 4000Hz PWM 6000Hz PWM 15000Hz Reset P/T Reset Iris/Prism Reset Color/CMY Reset Gobo/Gobo rotate No function Reset Frost/Animation Reset All No function	0		

37 channels

Channel 1 – Horizontal movement (Pan)

Push the slider up, in order to move head horizontally (PAN).
Gradual head adjustment from one end of the slider to the other (0-255, 128-center).
The head can be turned by 540° and stopped at any position you wish.

Channel 2 – Pan fine 16 bit

Channel 3 – Vertical movement (Tilt)

Push the slider up, in order to move head vertically (TILT).
Gradual head adjustment from one end of the slider to the other (0-255, 128-center).
The head can be turned by 270° and stopped at any position you wish.

Channel 4 – Tilt fine 16 bit

Channel 5 – PAN/TILT Speed

0-255 From fast to slow

Channel 6 – Master dimmer

0-255 Dimmer intensity, from OFF to full ON

Channel 7 – Dimmer fine 16 bit

0-255 Dimmer intensity, from OFF to full ON

Channel 8 – Shutter/Strobe ⚠ CH6 must be open ⚠

0-3	Closed
4-7	Shutter open
8-76	Strobe flash, from low to high frequency
77-145	Pulse strobe, from low to high frequency
146-215	Random strobe, from low to high frequency
216-255	Shutter open

Channel 9 – Color wheel ⚠ CH6 and CH8 must be open ⚠

0-6	White
7-13	Color 1 (Red)
14-20	Color 2 (Light Pink)
21-27	Color 3 (Amber)
28-34	Color 4 (Dark Lavender)
35-41	Color 5 (Primary Green)
42-48	Color 6 (Aquamarine)
49-59	Color 7 (Congo Blue)
60-187	Gradual color adjustment
188-219	Counterclockwise color flow, from fast to slow
220-223	Stop
224-255	Clockwise color flow, from slow to fast

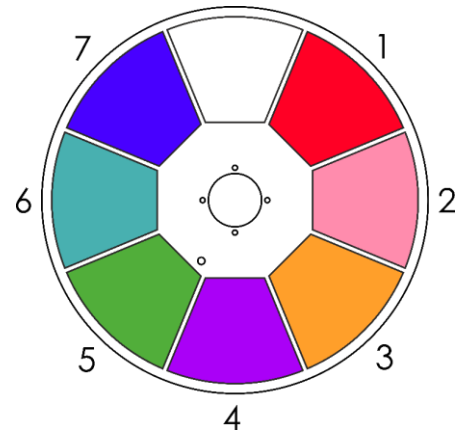

Channel 10 – Cyan Dimmer intensity ⚠ CH6 and CH8 must be open ⚠

0-255 Gradual adjustment Cyan from 0-100%

Channel 11 – Cyan Dimmer intensity 16 bit ⚠ CH6 and CH8 must be open ⚠

Channel 12 – Magenta Dimmer intensity ⚠ CH6 and CH8 must be open ⚠

0-255 Gradual adjustment Magenta from 0-100%

Channel 13 – Magenta Dimmer intensity 16 bit ⚠ CH6 and CH8 must be open ⚠

Channel 14 – Yellow Dimmer intensity ⚠️ CH6 and CH8 must be open ⚠️

0-255 Gradual adjustment Yellow from 0-100%

Channel 15 – Yellow Dimmer intensity 16 bit ⚠️ CH6 and CH8 must be open ⚠️

Channel 16 – CTO Dimmer intensity ⚠️ CH6 and CH8 must be open ⚠️

0-255 Gradual adjustment CTO from 0-100%

Channel 17 – CTO Dimmer intensity 16 bit ⚠️ CH6 and CH8 must be open ⚠️

Channel 18 – CMY macros ⚠️ CH6 and CH8 must be open ⚠️

0-9 Not functional
 10-127 CMY colors
 128-255 CMY macro, from fast to slow

Channel 19 – Rotating Gobo wheel

⚠️ CH6 and CH8 must be open ⚠️

0-8 Open
 9-17 Gobo 1 (Asteroids)
 18-26 Gobo 2 (Psycho)
 27-35 Gobo 3 (Brushed)
 36-44 Gobo 4 (Triangles)
 45-53 Gobo 5 (Baroque)
 54-63 Gobo 6 (Spiral)
 64-73 Rotating Gobo 6 shake effect, from slow to fast
 74-82 Rotating Gobo 5 shake effect, from slow to fast
 83-91 Rotating Gobo 4 shake effect, from slow to fast
 92-100 Rotating Gobo 3 shake effect, from slow to fast
 101-109 Rotating Gobo 2 shake effect, from slow to fast
 110-118 Rotating Gobo 1 shake effect, from slow to fast
 119-127 Open
 128-190 Clockwise gobo flow, from fast to slow
 191-192 Stop
 193-255 Counterclockwise gobo flow, from slow to fast

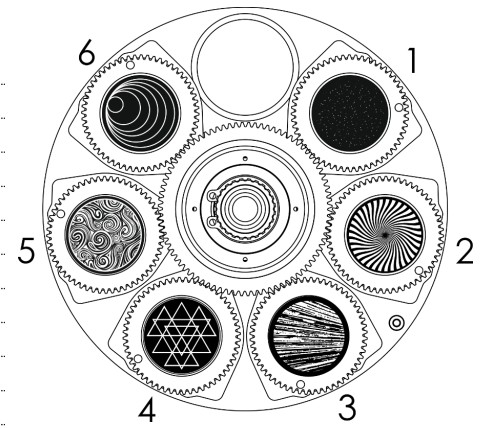

Channel 20 – Gobo rotation

0-45 Gobo indexing
 46-126 Clockwise gobo rotation, from fast to slow
 127-130 Stop
 131-211 Counterclockwise gobo rotation, from slow to fast
 212-255 Gobo wheel bounce effect, from small to big amplitude

Channel 21 – Gobo rotation 16 bit

Channel 22 – Static Gobo wheel

⚠ CH6 and CH8 must be open ⚠

0-6	Open
7-13	Gobo 1 (Circle)
14-20	Gobo 2 (Radial Lines)
21-27	Gobo 3 (Spokes)
28-34	Gobo 4 (Twist)
35-41	Gobo 5 (Organic)
42-48	Gobo 6 (Digi Blocks)
49-63	Gobo 7 (Vector)
64-70	Gobo 7 shake effect, from slow to fast
71-77	Gobo 6 shake effect, from slow to fast
78-84	Gobo 5 shake effect, from slow to fast
85-91	Gobo 4 shake effect, from slow to fast
92-98	Gobo 3 shake effect, from slow to fast
99-105	Gobo 2 shake effect, from slow to fast
106-112	Gobo 1 shake effect, from slow to fast
113-127	Open
128-190	Clockwise gobo flow, from fast to slow
191-192	Stop
193-255	Counterclockwise gobo flow, from slow to fast

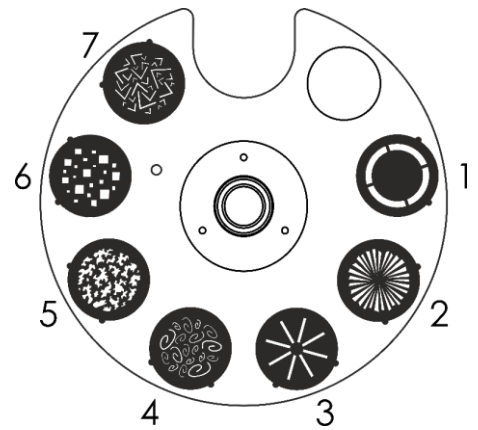

Channel 23 – Prism

0-4	Not functional
5-127	Prism effect 1
128-255	Prism effect 2

Channel 24 – Prism rotation

0-45	Prism indexing
46-126	Clockwise prism rotation, from fast to slow
127-130	Stop
131-211	Counterclockwise prism rotation, from slow to fast
212-255	Prism bounce effect, from small to big amplitude

Channel 25 – Prism rotation 16 bit

Channel 26 – Zoom

0-255	Zoom adjustment, from big to small
-------	------------------------------------

Channel 27 – Zoom 16 bit

Channel 28 – Iris

0-255	Iris adjustment, from big to small
-------	------------------------------------

Channel 29 – Iris 16 bit

Channel 30 – Iris macros ⚠ CH6 and CH8 must be open ⚠

0-63	Not functional
64-127	Macro switch, from slow to fast
128-191	Slow zoom out/fast zoom in, from slow to fast
192-255	Slow zoom in/fast zoom out, from slow to fast

Channel 31 – Focus

0-255	Focus adjustment
-------	------------------

Channel 32 – Focus 16 bit

Channel 33 – Auto focus

0	Not functional
1-11	0-5 meters, auto focus gobo 1
12-22	6 meters, auto focus gobo 1
23-33	7 meters, auto focus gobo 1
34-44	8 meters, auto focus gobo 1
45-55	9 meters, auto focus gobo 1
56-66	10 meters, auto focus gobo 1
67-77	12,5 meters, auto focus gobo 1
78-88	15 meters, auto focus gobo 1
89-99	17,5 meters, auto focus gobo 1
100-110	20-60 meters, auto focus gobo 1
111-127	Auto detect distance gobo1
128-138	0-5 meters, auto focus gobo 2
139-149	6 meters, auto focus gobo 2
150-160	7 meters, auto focus gobo 2
161-171	8 meters, auto focus gobo 2
172-182	9 meters, auto focus gobo 2
183-193	10 meters, auto focus gobo 2
194-204	12,5 meters, auto focus gobo 2
205-215	15 meters, auto focus gobo 2
216-226	17,5 meters, auto focus gobo 2
227-237	20-60 meters, auto focus gobo 2
238-255	Auto detect distance gobo 2

Channel 34 – Frost

0-255	Frost effect, 0-100%
-------	----------------------

Channel 35 – Animation wheel

⚠ CH6 and CH8 must be open ⚠

0-1	Not functional
2-126	Clockwise rotation, from fast to slow
127-130	Stop
131-255	Counterclockwise rotation, from slow to fast

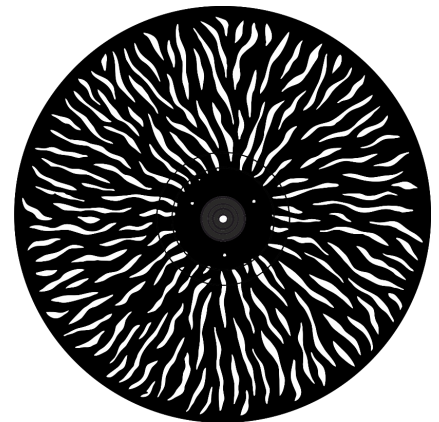

Channel 36 – Digital motion FX ⚠ CH6 and CH8 must be open ⚠

0-1	Not functional
2-128	Step mode, from slow to fast
129-255	Fade mode, from slow to fast

Channel 37 – Functions

0-5	Not functional
6-11	Pan reverse
12-17	Pan normal
18-23	Tilt reverse
24-29	Tilt normal
30-35	Pan/Tilt swop
36-41	Pan/Tilt normal
42-47	P/T blackout ON
48-53	P/T blackout OFF
54-59	Color wheel blackout ON
60-65	Color wheel blackout OFF
66-71	Rotating gobo wheel blackout ON
72-77	Rotating gobo wheel blackout OFF
78-83	Fans: Auto
84-89	Fans: Full
90-95	Fans: Silent
96-101	DMX fail: Hold
102-107	DMX fail: OFF
108-113	Linear dimmer mode
114-119	Square dimmer mode
120-125	I-Square dimmer mode
126-131	S-curve dimmer mode
132-137	PWM 600Hz
138-143	PWM 1200Hz
144-149	PWM 2000Hz
150-155	PWM 4000Hz
156-161	PWM 6000Hz
162-167	PWM 15000Hz
168-173	Pan/Tilt reset
174-179	Iris/Prism reset
180-185	Color wheel/CMY reset
186-191	Gobo wheel/Gobo rotation reset
192-203	Not functional
204-209	Frost/Animation wheel reset
210-215	Reset all
216-255	Not functional

26 channels

Channel 1 – Horizontal movement (Pan)

Push the slider up, in order to move head horizontally (PAN).
 Gradual head adjustment from one end of the slider to the other (0-255, 128-center).
 The head can be turned by 540° and stopped at any position you wish.

Channel 2 – Pan fine 16 bit

Channel 3 – Vertical movement (Tilt)

Push the slider up, in order to move head vertically (TILT).
 Gradual head adjustment from one end of the slider to the other (0-255, 128-center).
 The head can be turned by 270° and stopped at any position you wish.

Channel 4 – Tilt fine 16 bit

Channel 5 – Master dimmer

0-255 Dimmer intensity, from OFF to full ON

Channel 6 – Shutter/Strobe ⚠ CH5 must be open ⚠

0-3	Closed
4-7	Shutter open
8-76	Strobe flash, from low to high frequency
77-145	Pulse strobe, from low to high frequency
146-215	Random strobe, from low to high frequency
216-255	Shutter open

Channel 7 – Color wheel ⚠ CH5 and CH6 must be open ⚠

0-6	White
7-13	Color 1 (Red)
14-20	Color 2 (Light Pink)
21-27	Color 3 (Amber)
28-34	Color 4 (Dark Lavender)
35-41	Color 5 (Primary Green)
42-48	Color 6 (Aquamarine)
49-59	Color 7 (Congo Blue)
60-187	Gradual color adjustment
188-219	Counterclockwise color flow, from fast to slow
220-223	Stop
224-255	Clockwise color flow, from slow to fast

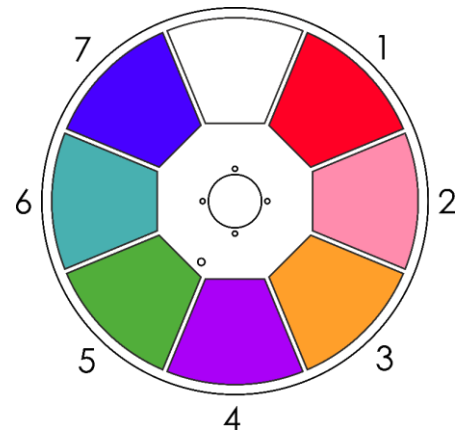

Channel 8 – Cyan Dimmer intensity ⚠ CH5 and CH6 must be open ⚠

0-255 Gradual adjustment Cyan from 0-100%

Channel 9 – Magenta Dimmer intensity ⚠ CH5 and CH6 must be open ⚠

0-255 Gradual adjustment Magenta from 0-100%

Channel 10 – Yellow Dimmer intensity ⚠ CH5 and CH6 must be open ⚠

0-255 Gradual adjustment Yellow from 0-100%

Channel 11 – CTO Dimmer intensity ⚠ CH5 and CH6 must be open ⚠

0-255 Gradual adjustment CTO from 0-100%

Channel 12 – CMY macros ⚠️ **CH5 and CH6 must be open** ⚠️

0-9	Not functional
10-127	CMY colors
128-255	CMY macro, from fast to slow

Channel 13 – Rotating Gobo wheel

⚠️ **CH5 and CH6 must be open** ⚠️

0-8	Open
9-17	Gobo 1 (Asteroids)
18-26	Gobo 2 (Psycho)
27-35	Gobo 3 (Brushed)
36-44	Gobo 4 (Triangles)
45-53	Gobo 5 (Baroque)
54-63	Gobo 6 (Spiral)
64-73	Rotating Gobo 6 shake effect, from slow to fast
74-82	Rotating Gobo 5 shake effect, from slow to fast
83-91	Rotating Gobo 4 shake effect, from slow to fast
92-100	Rotating Gobo 3 shake effect, from slow to fast
101-109	Rotating Gobo 2 shake effect, from slow to fast
110-118	Rotating Gobo 1 shake effect, from slow to fast
119-127	Open
128-190	Clockwise gobo flow, from fast to slow
191-192	Stop
193-255	Counterclockwise gobo flow, from slow to fast

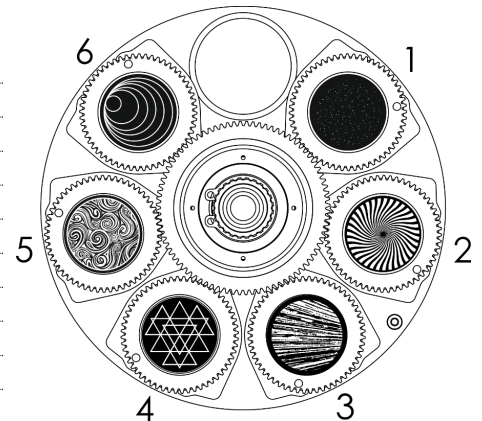

Channel 14 – Gobo rotation

0-45	Gobo indexing
46-126	Clockwise gobo rotation, from fast to slow
127-130	Stop
131-211	Counterclockwise gobo rotation, from slow to fast
212-255	Gobo wheel bounce effect, from small to big amplitude

Channel 15 – Static Gobo wheel

⚠️ **CH5 and CH6 must be open** ⚠️

0-6	Open
7-13	Gobo 1 (Circle)
14-20	Gobo 2 (Radial Lines)
21-27	Gobo 3 (Spokes)
28-34	Gobo 4 (Twist)
35-41	Gobo 5 (Organic)
42-48	Gobo 6 (Digi Blocks)
49-63	Gobo 7 (Vector)
64-70	Gobo 7 shake effect, from slow to fast
71-77	Gobo 6 shake effect, from slow to fast
78-84	Gobo 5 shake effect, from slow to fast
85-91	Gobo 4 shake effect, from slow to fast
92-98	Gobo 3 shake effect, from slow to fast
99-105	Gobo 2 shake effect, from slow to fast
106-112	Gobo 1 shake effect, from slow to fast
113-127	Open
128-190	Clockwise gobo flow, from fast to slow
191-192	Stop
193-255	Counterclockwise gobo flow, from slow to fast

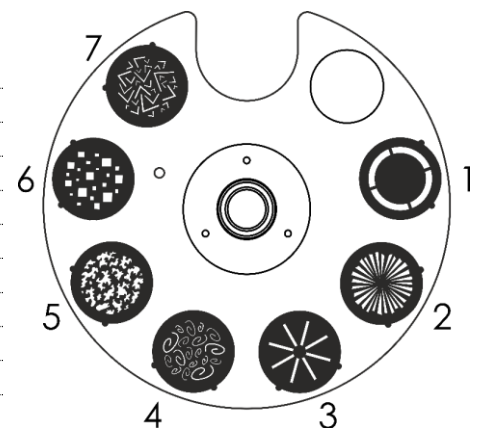

Channel 16 – Prism

0-4	Not functional
5-127	Prism effect 1
128-255	Prism effect 2

Channel 17 – Prism rotation

0-45	Prism indexing
46-126	Clockwise prism rotation, from fast to slow
127-130	Stop
131-211	Counterclockwise prism rotation, from slow to fast
212-255	Prism bounce effect, from small to big amplitude

Channel 18 – Zoom

0-255	Zoom adjustment, from big to small
-------	------------------------------------

Channel 19 – Iris

0-255	Iris adjustment, from big to small
-------	------------------------------------

Channel 20 – Iris macros CH5 and CH6 must be open

0-63	Not functional
64-127	Macro switch, from slow to fast
128-191	Slow zoom out/fast zoom in, from slow to fast
192-255	Slow zoom in/fast zoom out, from slow to fast

Channel 21 – Focus

0-255	Focus adjustment
-------	------------------

Channel 22 – Auto focus

0	Not functional
1-11	0-5 meters, auto focus gobo 1
12-22	6 meters, auto focus gobo 1
23-33	7 meters, auto focus gobo 1
34-44	8 meters, auto focus gobo 1
45-55	9 meters, auto focus gobo 1
56-66	10 meters, auto focus gobo 1
67-77	12,5 meters, auto focus gobo 1
78-88	15 meters, auto focus gobo 1
89-99	17,5 meters, auto focus gobo 1
100-110	20-60 meters, auto focus gobo 1
111-127	Auto detect distance gobo 1
128-138	0-5 meters, auto focus gobo 2
139-149	6 meters, auto focus gobo 2
150-160	7 meters, auto focus gobo 2
161-171	8 meters, auto focus gobo 2
172-182	9 meters, auto focus gobo 2
183-193	10 meters, auto focus gobo 2
194-204	12,5 meters, auto focus gobo 2
205-215	15 meters, auto focus gobo 2
216-226	17,5 meters, auto focus gobo 2
227-237	20-60 meters, auto focus gobo 2
238-255	Auto detect distance gobo 2

Channel 23 – Frost

0-255	Frost effect, 0-100%
-------	----------------------

Channel 24 – Animation wheel

⚠ CH5 and CH6 must be open ⚠

0-1	Not functional
2-126	Clockwise rotation, from fast to slow
127-130	Stop
131-255	Counterclockwise rotation, from slow to fast

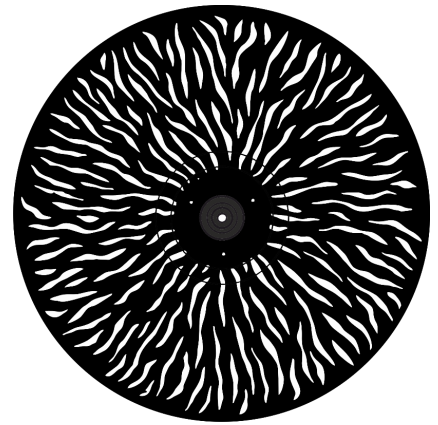

Channel 25 – Digital motion FX ⚠ CH5 and CH6 must be open ⚠

0-1	Not functional
2-128	Step mode, from slow to fast
129-255	Fade mode, from slow to fast

Channel 26 – Functions

0-5	Not functional
6-11	Pan reverse
12-17	Pan normal
18-23	Tilt reverse
24-29	Tilt normal
30-35	Pan/Tilt swop
36-41	Pan/Tilt normal
42-47	P/T blackout ON
48-53	P/T blackout OFF
54-59	Color wheel blackout ON
60-65	Color wheel blackout OFF
66-71	Rotating gobo wheel blackout ON
72-77	Rotating gobo wheel blackout OFF
78-83	Fans: Auto
84-89	Fans: Full
90-95	Fans: Silent
96-101	DMX fail: Hold
102-107	DMX fail: OFF
108-113	Linear dimmer mode
114-119	Square dimmer mode
120-125	I-Square dimmer mode
126-131	S-curve dimmer mode
132-137	PWM 600Hz
138-143	PWM 1200Hz
144-149	PWM 2000Hz
150-155	PWM 4000Hz
156-161	PWM 6000Hz
162-167	PWM 15000Hz
168-173	Pan/Tilt reset
174-179	Iris/Prism reset
180-185	Color wheel/CMY reset
186-191	Gobo wheel/Gobo rotation reset
192-203	Not functional
204-209	Frost/Animation wheel reset
210-215	Reset all
216-255	Not functional

Maintenance

The operator has to make sure that safety-related and machine-technical installations are to be inspected by an expert after every year in the course of an acceptance test.

The operator has to make sure that safety-related and machine-technical installations are to be inspected by a skilled person once a year.

The following points have to be considered during the inspection:

- 01) All screws used for installing the device or parts of the device have to be tightly connected and must not be corroded.
- 02) There may not be any deformations on housings, fixations and installation spots.
- 03) Mechanically moving parts like axles, eyes and others may not show any traces of wearing.
- 04) The electric power supply cables must not show any damages or material fatigue.

The Infinity S401 Spot requires almost no maintenance. However, you should keep the unit clean.

Otherwise, the fixture's light output will be significantly reduced. Disconnect the mains power supply, and then wipe the cover with a damp cloth. Do not immerse in liquid. Wipe lens clean with glass cleaner and a soft cloth. Do not use alcohol or solvents.

The front lens will require weekly cleaning, as smoke-fluid tends to build up residues, reducing the light output very quickly.

The cooling fans should be cleaned monthly, with a soft brush.

Please clean internal components once a year with a light brush and vacuum cleaner.

Keep connections clean. Disconnect electric power, and then wipe the DMX connections with a damp cloth. Make sure connections are thoroughly dry before linking equipment or supplying electric power.

Replacing the Fuse

Power surges, short-circuit or inappropriate electrical power supply may cause a fuse to burn out. If the fuse burns out, the product will not function whatsoever. If this happens, follow the directions below:

- 01) Unplug the unit from electric power source.
- 02) Insert a flat-head screwdriver into a slot in the fuse cover. Turn the screwdriver to the left, at the same time gently push a bit (Turn and Push). The fuse will come out.
- 03) Remove the used fuse. If brown or unclear, it is burned out.
- 04) Insert the replacement fuse into the holder where the old fuse was. Reinsert the fuse cover. Be sure to use a fuse of the same type and specification. See the product specification label for details.

Gobo Size

- 01) Disconnect mains power supply and set the switch to OFF.
- 02) Make sure that the gobo which you want to insert has the same size. For the right size, see below.

Rotating Gobo Wheel

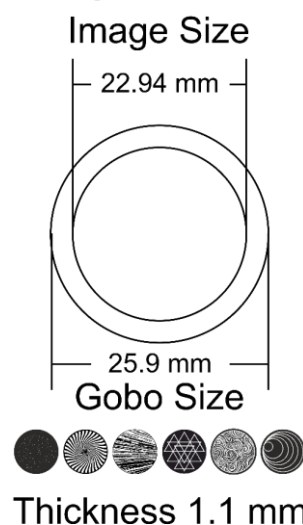

Fig. 09

Replacing a Gobo From the Rotating Gobo Wheel

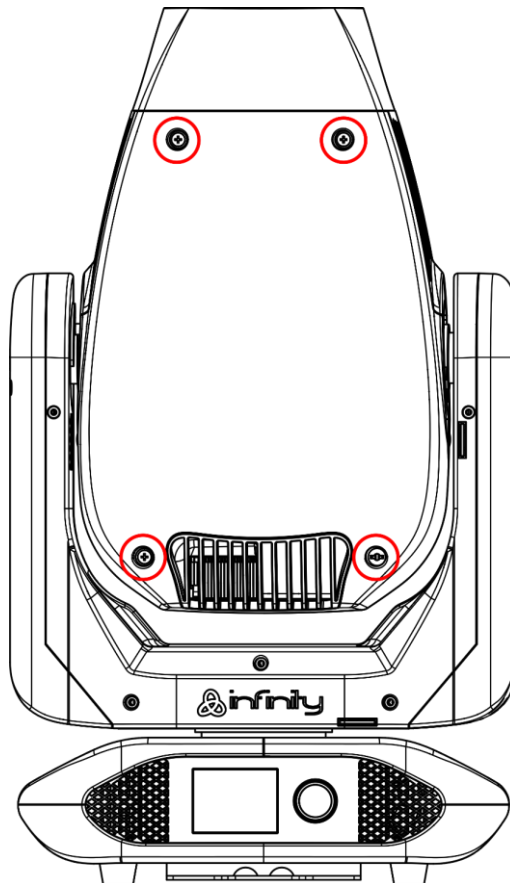

Fig. 10

- 01) Before removing the top part of the housing, make sure that the moving head is in the horizontal position. The lens position should be on the bottom, symmetrically speaking.
- 02) Loosen all the four screws on the back of the housing.
- 03) Gently tilt the head so that the small metal housing slides out easily.
- 04) Turn the gobo wheel until you reach the gobo which you want to remove.
- 05) Gently lift up the gobo holder 10° and then gently pull out the gobo from its position.

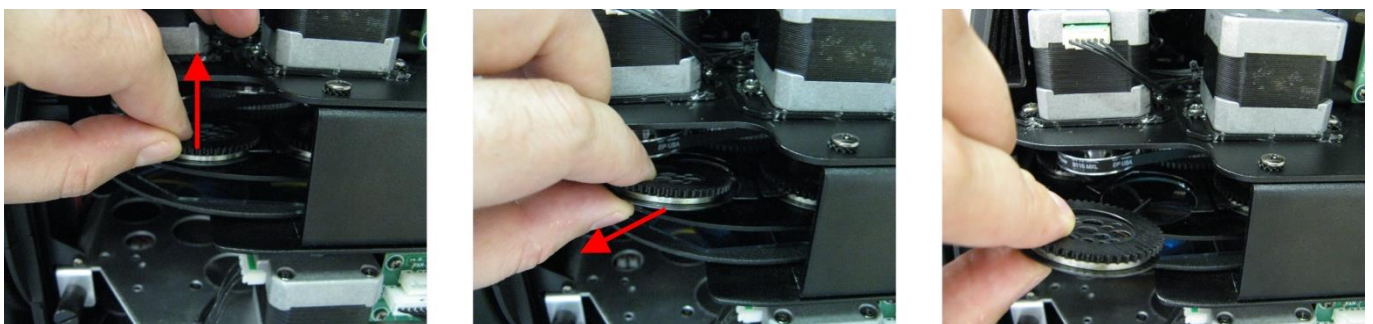

Fig. 11

- 06) Very carefully take the gobo out of the gobo holder with a pair of pliers.
- 07) Place the new gobo in the gobo holder. Carefully put the pinchcock back, gently press the pinchcock a little bit together. To do it, you can use a pair of pliers.
- 08) Put the gobo holder back. At first, you will notice some resistance which is caused by the way in which the holder was built.
- 09) Replace the maintenance caps and fasten all the screws.

Glass Gobo Orientation

Coated glass gobos are inserted with the coating against the rim of the holder (away from the spring). Textured gobos are inserted with the smooth side against the spring. This provides the best results when combining rotating gobos.

Coated side

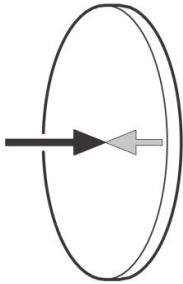

When an object is held up to the coated side, there is no space between the object and its reflection. The back edge of the gobo cannot be seen when looking through the coated side.

Uncoated side

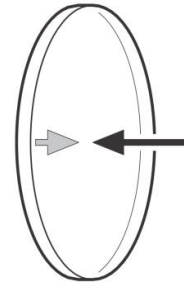

When an object is held up to the uncoated side, there is a space between the object and its reflection. The back edge of the gobo can be seen when looking through the uncoated side.

Rotating and Static Gobo Wheel, Color Wheel and Animation Wheel

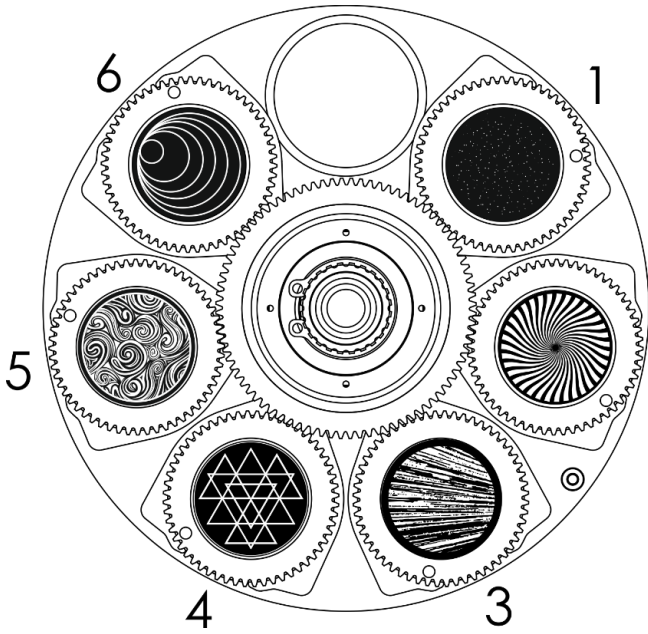

Rotating gobo wheel

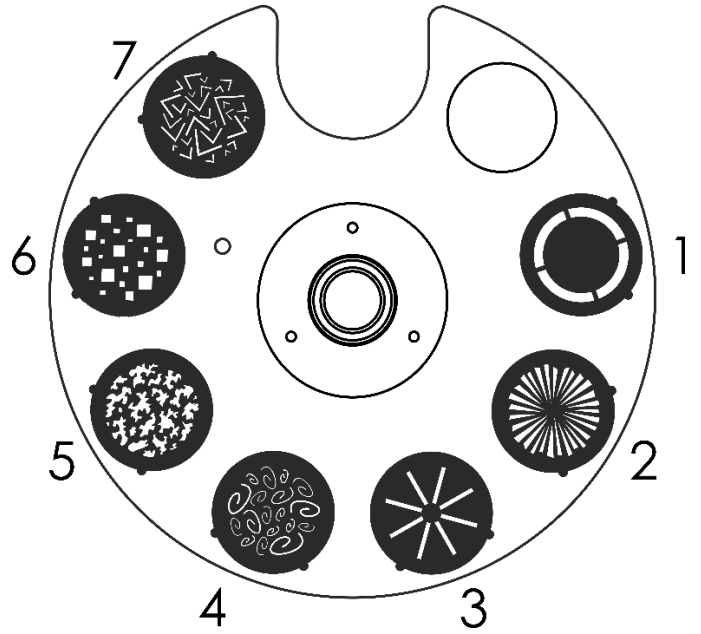

Static gobo wheel

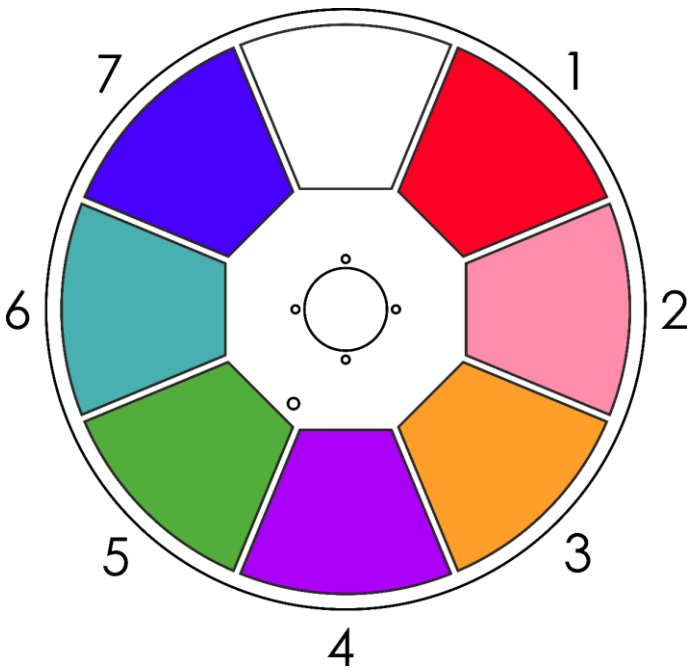

Color wheel

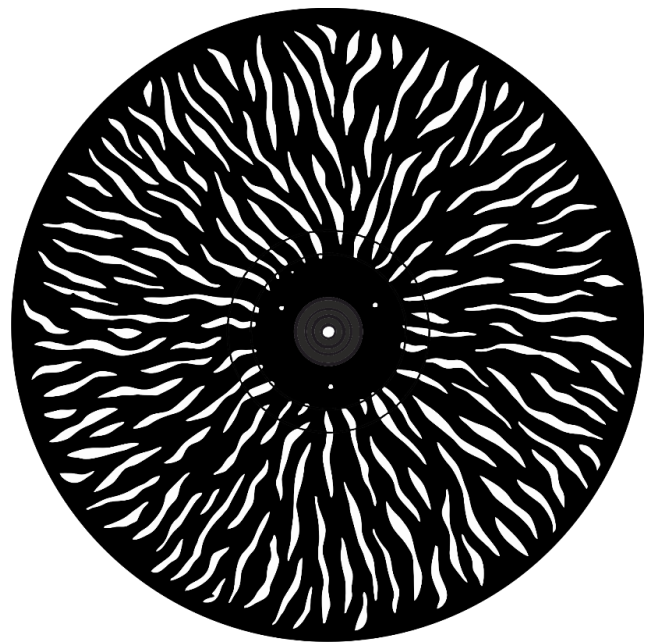

Animation wheel

Troubleshooting

This troubleshooting guide is meant to help solve simple problems.

If a problem occurs, carry out the steps below in sequence until a solution is found. Once the unit operates properly, do not carry out following steps.

No Light

If the light effect does not operate properly, refer servicing to a technician.

Suspect three potential problem areas as: the power supply, the LEDs, the fuse.

- 01) Power supply. Check if the unit is plugged into an appropriate power supply.
- 02) The LEDs. Return the device.
- 03) The fuse. Replace the fuse. See page 50 for replacing the fuse.
- 04) If all of the above appears to be O.K., plug the unit in again.
- 05) If you are unable to determine the cause of the problem, do not open the Infinity, as this may damage the unit and the warranty will become void.
- 06) Return the device to your Infinity dealer.

No Response to DMX

Suspect the DMX cable or connectors, a controller malfunction, a light effect DMX card malfunction.

- 01) Check the DMX setting. Make sure that DMX addresses are correct.
- 02) Check the DMX cable: Unplug the unit; change the DMX cable; then reconnect to electrical power. Try your DMX control again.
- 03) Determine whether the controller or light effect is at fault. Does the controller operate properly with other DMX products? If not, take the controller in for repair. If so, take the DMX cable and the light effect to a qualified technician.

Problem	Probable cause(s)	Solution
One or more fixtures do not function at all	No power to the fixture	<ul style="list-style-type: none"> • Check if power is switched on and cables are plugged in
	Primary fuse blown	<ul style="list-style-type: none"> • Replace fuse
Fixtures reset correctly, but all respond erratically or not at all to the controller	The controller is not connected	<ul style="list-style-type: none"> • Connect controller
	5-pin XLR Out of the controller does not match XLR Out of the first fixture on the link (i.e. signal is reversed)	<ul style="list-style-type: none"> • Install a phase reversing cable between the controller and the first fixture on the link
Fixtures reset correctly, but some respond erratically or not at all to the controller	Poor data quality	<ul style="list-style-type: none"> • Check data quality. If much lower than 100 percent, the problem may be a bad data link connection, poor quality or broken cables, missing termination plug, or a defective fixture disturbing the link
	Bad data link connection	<ul style="list-style-type: none"> • Inspect connections and cables. Correct poor connections. Repair or replace damaged cables
	Data link not terminated with 120 Ohm termination plug	<ul style="list-style-type: none"> • Insert termination plug in output jack of the last fixture on the link
	Incorrect addressing of the fixtures	<ul style="list-style-type: none"> • Check address setting
	One of the fixtures is defective and disturbs data transmission on the link	<ul style="list-style-type: none"> • Bypass one fixture at a time until normal operation is restored: unplug both connectors and connect them directly together • Have the defective fixture serviced by a qualified technician
	5-pin XLR Out on the fixtures does not match (pins 2 and 3 reversed)	<ul style="list-style-type: none"> • Install a phase-reversing cable between the fixtures or swap pin 2 and 3 in the fixture that behaves erratically
No light or LEDs cut out intermittently	Fixture is too hot	<ul style="list-style-type: none"> • Allow the fixture to cool down • Clean the fan • Make sure air vents in control panel and the front lens are not blocked • Turn up the air conditioning
	LEDs damaged	<ul style="list-style-type: none"> • Disconnect the fixture and return it to your dealer
	The power supply settings do not match local AC voltage and frequency	<ul style="list-style-type: none"> • Disconnect fixture. Check settings and correct if necessary

Product Specifications

Model:	Infinity S401 Spot
Input voltage:	100-240V AC, 50/60Hz
Power consumption:	610W (full output)
DMX linking:	30pcs
Fuse:	F12AL/250V
Dimensions:	385 x 284 x 680 mm (LxWxH)
Weight:	28,9 kg
Operating and Programming:	
Signal pin OUT:	Pin 1 (earth), pin 2 (-), pin 3 (+), pin 4 (N/C), pin 5 (N/C)
DMX Mode:	Basic (26 channels), Advance (37 channels), User (up to 37 channels)
Signal input:	5-pin XLR IN
Signal output:	5-pin XLR OUT
Electro-mechanical effects:	
Light source:	1 x 350W White LED
Lux @ 5m 6°:	34442
Lux @ 5m 30°:	2205
Color temperature:	7500K
Beam angle:	6° - 30°
Onboard:	Battery-powered, fixture orientated touch display
Motorized zoom:	8, 16 bit
Motorized iris:	0-100%
Focus:	Motorized auto focus
Dimmer:	16 bit, 0-100%
Strobe:	0-20Hz
CMY:	0-100%
CTO:	0-100%
Pan:	540°
Tilt:	270°
Pan/Tilt resolution:	16 bit
Special:	Fixture orientated auto pan invert
Rotating gobo wheel:	6 glass gobos + open
Static gobo wheel:	7 metal gobos + open
Gobo rotation:	Bi-directional
Gobo functions:	Gobo-flow effect, Gobo shake
Gobo index:	8, 16 bit
Gobo size:	Glass gobo: 25,9 mm (gobo size); 22,94 mm (image diameter); 1,1 mm (gobo thickness)
Color wheel:	7 dichroic filters + white
Color functions:	Split colors, Rainbow-flow effect, CMY macros
Prisms:	3-facet circular prism & 5-facet linear rotating prism
Animation:	Continuously bi-rotating flame wheel & digital motion FX
Frost filter:	Yes
Selectable PWM:	0,6/1,5/2/4/6/15 kHz
Housing:	Metal & flame-retardant plastic
IP rating:	IP20
DMX control:	via standard DMX controller
Onboard:	LCD display with gravity sensor
Color:	Black
Control modes:	Stand-Alone, Manual, DMX-512, W-DMX, ArtNet
Connections:	Dedicated PowerCON True1 & RJ45 data connector
Control protocol:	DMX, W-DMX, RDM, sACN, ArtNet
Wireless DMX:	Wireless Solutions Sweden
Max. ambient temperature t_a :	40°C
Max. housing temperature t_b :	80°C
Minimum distance:	
Minimum distance from flammable surfaces:	0,5 m
Minimum distance to lighted object:	1 m

Design and product specifications are subject to change without prior notice.



Website: www.highlite.com

Email: service@highlite.com

Dimensions

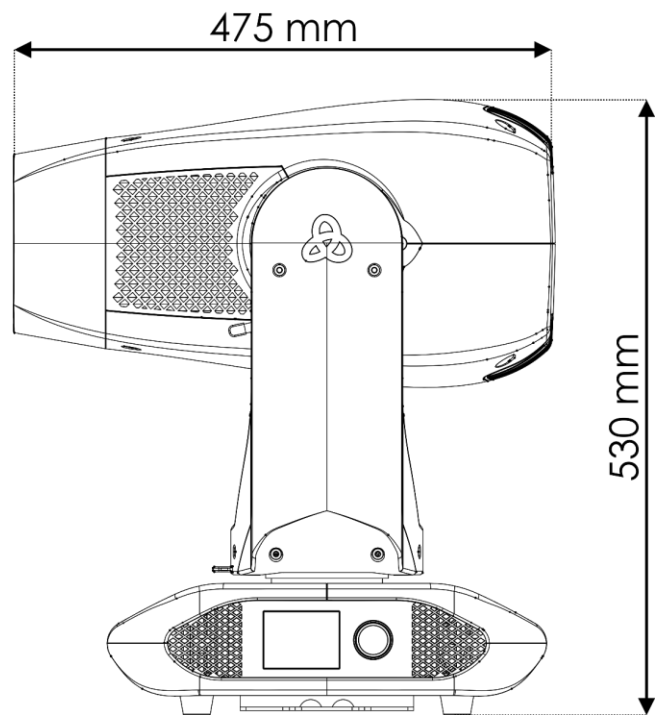
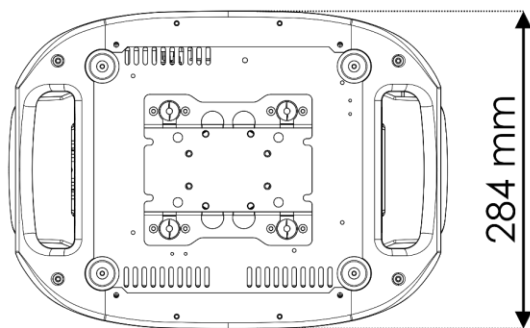
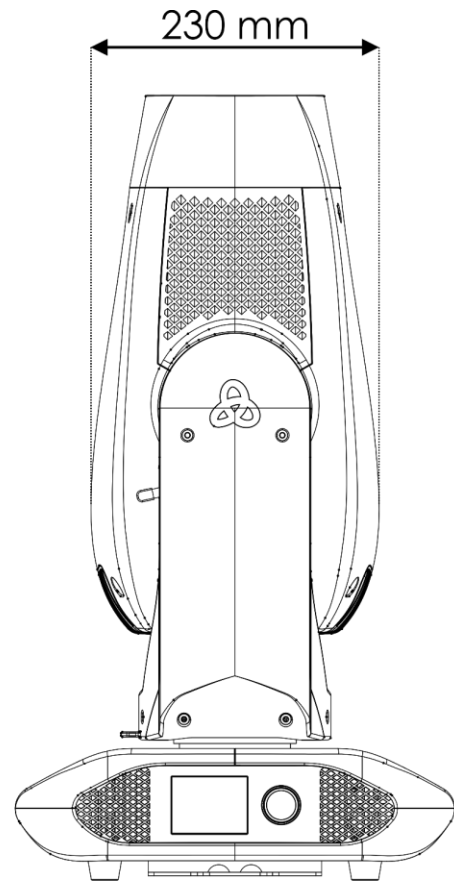
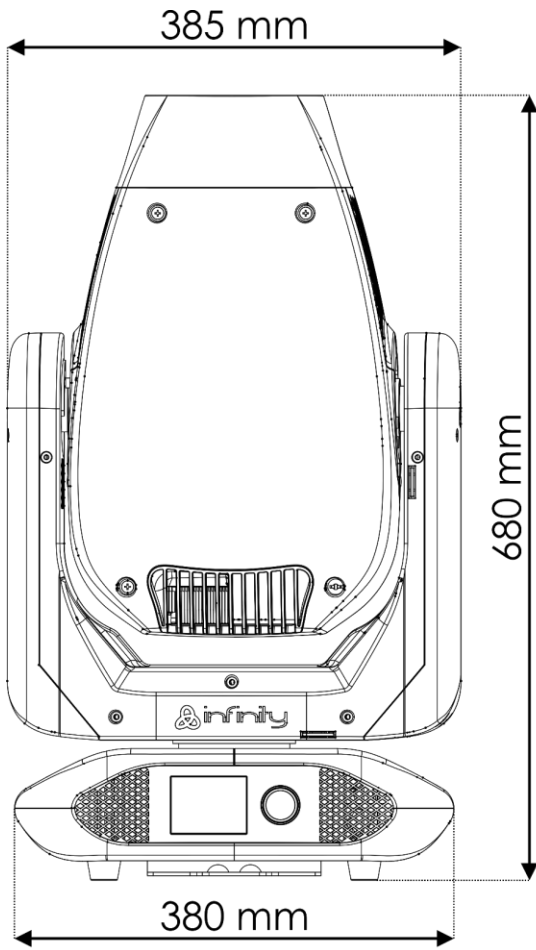

Moving Head Position / DMX Values

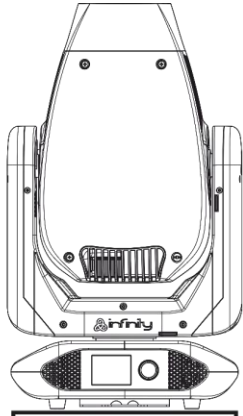

Pan 127 - Tilt 127

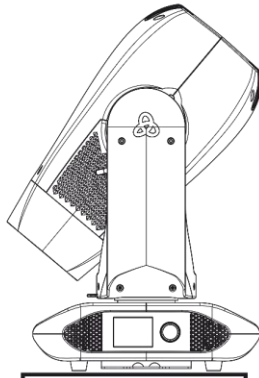

Pan 0 - Tilt 0

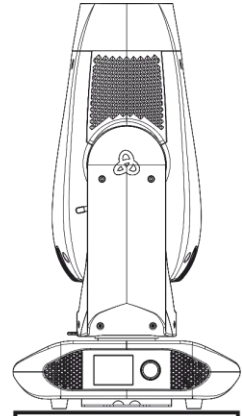

Pan 0 - Tilt 127

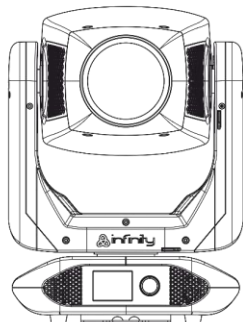

Pan 42 - Tilt 45

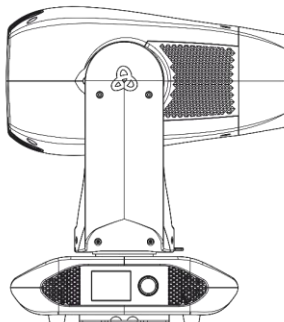

Pan 85 - Tilt 45

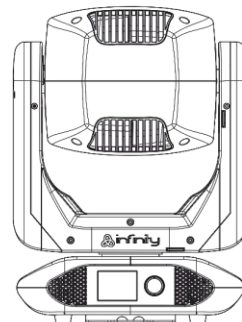

Pan 127 - Tilt 45

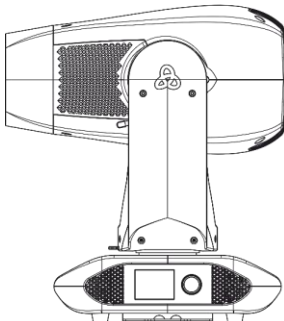

Pan 0 - Tilt 45

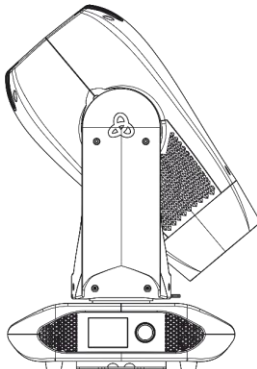

Pan 0 - Tilt 255

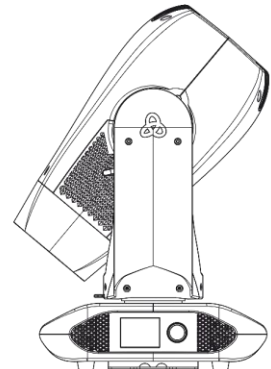

Pan 255 - Tilt 255

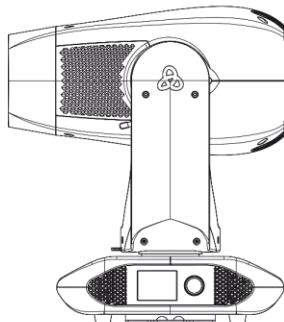

Pan 169 - Tilt 45

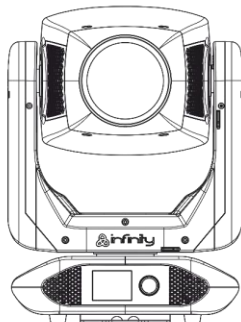

Pan 214 - Tilt 45

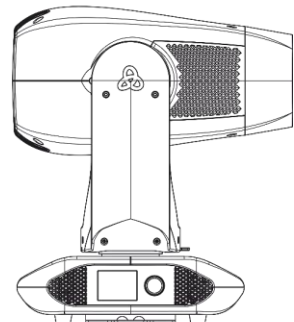

Pan 255 - Tilt 45



©2019 Infinity