



# Eventspot 1900 mkII

ORDERCODE 42717



Highlite International B.V.  
Vestastraat 2  
6468 EX Kerkrade  
The Netherlands  
Phone: +31 45-5667700

**SHOWELECTRONICS FOR PROFESSIONALS**

## **Congratulations!**

You have bought a great, innovative product from Showtec.

The Showtec Eventspot 1900 mkII brings excitement to any venue. Whether you want simple plug-&-play action or a sophisticated DMX show, this product provides the effect you need.

You can rely on Showtec, for more excellent lighting products.

We design and manufacture professional light equipment for the entertainment industry.

New products are being launched regularly. We work hard to keep you, our customer, satisfied.

For more information: [iwant@showtec.info](mailto:iwant@showtec.info)

You can get some of the best quality, best priced products on the market from Showtec.

So next time, turn to Showtec for more great lighting equipment.

Always get the best -- with Showtec !

Thank you!



<b>Warning</b> .....	3
Safety Instructions .....	3
Operating Determinations .....	5
Return Procedure.....	5
Claims .....	5
<b>Description of the device</b> .....	6
Optional accessories.....	6
DMX Channel Summary .....	7
Overview .....	8
<b>Installation</b> .....	9
<b>Set Up and Operation</b> .....	9
Operating position.....	9
Charging the built in battery.....	10
Fixture Linking.....	10
Data Cabling.....	10
Control Modes.....	11
One Eventspot 1900 mkII (Built-in Programs) .....	11
Multiple Eventspots (Master/Slave control) .....	11
Multiple Eventspots (Wireless DMX Control) .....	11
Multiple Eventspots (DMX Control) .....	11
Control Panel.....	13
DMX Control Mode.....	13
DMX Addressing .....	13
Menu overview .....	14
Main Menu Options .....	16
Creating a static color .....	16
Activating an Auto Program .....	17
DMX 512 Address.....	17
Run Mode.....	17
Personality.....	18
Changing the Settings .....	18
Edit Custom .....	19
White Settings.....	20
Making a custom white color.....	20
WDMX Settings .....	20
Keylock settings .....	21
DMX Channels.....	22
DMX Control TOUR .....	22
DMX Control ARC1 .....	23
DMX Control ARC1+D .....	23
DMX Control ARC1+S.....	24
DMX Control HSV .....	24
DMX Control BLOCK.....	24
<b>Maintenance</b> .....	24
<b>Troubleshooting</b> .....	24
No Light .....	24
No Response to DMX.....	25
<b>Product Specification</b> .....	26

## Warning

**FOR YOUR OWN SAFETY, PLEASE READ THIS USER MANUAL CAREFULLY  
BEFORE YOUR INITIAL START-UP!**

## Unpacking Instructions

Immediately upon receiving this product, carefully unpack the carton and check the contents to ensure that all parts are present, and have been received in good condition. Notify the dealer immediately and retain packing material for inspection if any parts appear damaged from shipping or the carton itself shows signs of mishandling. Save the carton and all packing materials. In the event that a fixture must be returned to the factory, it is important that the fixture be returned in the original factory box and packing.

### Your shipment includes:

- Eventspot 1900 mkII
- User manual



## LED Expected Lifespan

LEDs gradually decline in brightness over time. HEAT is the dominant factor that leads to the acceleration of this decline. Packaged in clusters, LEDs exhibit higher operating temperatures than in ideal or singular optimum conditions. For this reason when all color LEDs are used at their fullest intensity, life of the LEDs is significantly reduced. It is estimated that a viable lifespan of 40,000 to 50,000 hours will be achieved under normal operational conditions. If improving on this lifespan expectancy is of a higher priority, place care in providing for lower operational temperatures. This may include climatic-environmental and the reduction of overall projection intensity.

## Safety Instructions

Every person involved with the installation, operation and maintenance of this device has to:

- be qualified
- follow the instructions of this manual



**CAUTION! Be careful with your operations.  
With a dangerous voltage you can suffer  
a dangerous electric shock when touching the wires!**



Before your initial start-up, please make sure that there is no damage caused by transportation. Should there be any, consult your dealer and do not use the device.

To maintain perfect condition and to ensure a safe operation, it is absolutely necessary for the user to follow the safety instructions and warning notes written in this manual.

Please consider that damages caused by manual modifications to the device are not subject to warranty.

This device contains no user-serviceable parts. Refer servicing to qualified technicians only.

### **IMPORTANT:**

*The manufacturer will not accept liability for any resulting damages caused by the non-observance of this manual or any unauthorized modification to the device.*

- Never remove warning or informative labels from the unit.
- Never use anything to cover the ground contact of the (optional) battery charger.
- Never look directly into the light source.
- Never leave any cables lying around.
- Never use the device during thunderstorms, unplug the device immediately.
- Never leave various parts of the packaging (plastic bags, polystyrene foam, nails, etc.) within children's reach, as they are potential sources of danger.
- Do not insert objects into air vents.
- Do not open the device and do not modify the device.
- Do not shake the device. Avoid brute force when installing or operating the device.
- Do not switch the device on and off in short intervals, as this would reduce the system's life.
- Only operate the device after having familiarized with its functions.
- Avoid flames and do not put close to flammable liquids or gases.
- Always allow free air space of at least 50 cm around the unit for ventilation.
- Make sure that the device is not exposed to extreme heat, moisture or dust.
- If the lens is obviously damaged, it has to be replaced. So that its functions are not impaired, due to cracks or deep scratches.
- If device is dropped or struck, switch off the device. Have a qualified engineer inspect for safety before operating.
- If the device has been exposed to drastic temperature fluctuation (e.g. after transportation), do not switch it on immediately. The arising condensation water might damage your device. Leave the device switched off until it has reached room temperature.
- If your Showtec device fails to work properly, discontinue use immediately. Pack the unit securely (preferably in the original packing material), and return it to your Showtec dealer for service.
- For adult use only. The device must be installed out of the reach of children. Never leave the unit running unattended.
- The user is responsible for correct positioning and operating of the Eventspot 1900 mkII. The manufacturer will not accept liability for damages caused by the misuse or incorrect installation of this device.
- Repairs, servicing and electric connection must be carried out by a qualified technician.
- WARRANTY: Till one year after date of purchase.



**CAUTION ! EYEDAMAGES !**  
**Avoid looking directly into the light source.**  
**(meant especially for epileptics) !**



## Operating Determinations

- This device is not designed for permanent operation. Consistent operation breaks will ensure that the device will serve you for a long time without defects.
- The minimum distance between light-output and the illuminated surface must be more than 0.5 meter.
- The maximum ambient temperature  $t_a = 45^\circ\text{C}$  must never be exceeded.
- The relative humidity must not exceed 50 % with an ambient temperature of  $45^\circ\text{C}$ .
- If this device is operated in any other way, than the one described in this manual, the product may suffer damages and the warranty becomes void.
- Any other operation may lead to dangers like short-circuit, burns, electric shock, crash etc.

You endanger your own safety and the safety of others!

*Improper installation can cause serious damage to people and property !*

## Return Procedure

Returned merchandise must be sent prepaid and in the original packing, call tags will not be issued. Package must be clearly labeled with a Return Authorization Number (RMA number). Products returned

without an RMA number will be refused. Highlite will not accept the returned goods or any responsibility. Call Highlite 0031-455667723 or mail [aftersales@highlite.nl](mailto:aftersales@highlite.nl) and request an RMA prior to shipping the fixture. Be prepared to provide the model number, serial number and a brief description of the cause for the return. Be sure to properly pack fixture, any shipping damage resulting from inadequate packaging is the customer's responsibility. Highlite reserves the right to use its own discretion to repair or replace product(s). As a suggestion, proper UPS packing or double-boxing is always a safe method to use.

**Note: If you are given an RMA number, please include the following information on a piece of paper inside the box:**

- 1) Your name
- 2) Your address
- 3) Your phone number
- 4) A brief description of the symptoms

## Claims

The client has the obligation to check the delivered goods immediately upon delivery for any shortcomings and/or visible defects, or perform this check after our announcement that the goods are at their disposal. Damage incurred in shipping is the responsibility of the shipper; therefore the damage must be

reported to the carrier upon receipt of merchandise.

It is the customer's responsibility to notify and submit claims with the shipper in the event that a fixture is damaged due to shipping. Transportation damage has to be reported to us within one day after receipt of the delivery.

Any return shipment has to be made post-paid at all times. Return shipments must be accompanied with a letter defining the reason for return shipment. Non-prepaid return shipments will be refused, unless otherwise agreed in writing.

Complaints against us must be made known in writing or by fax within 10 working days after receipt of the invoice. After this period complaints will not be handled anymore.

Complaints will only then be considered if the client has so far complied with all parts of the agreement, regardless of the agreement of which the obligation is resulting.

## Description of the device

The Eventspot 1900 mkII is a wireless LED Eventspot from Showtec.

### Features

- Compact and lightweight
- RGBA color mixing
- Sealed battery (12 hours at full RGB on)
- For (temporary) outdoor use
- Ideal for all kinds of events and a true leader in his class
- 3 in 1 RGB LED's combined with dedicated high class optics ensuring a bright and well defined beam
- Adjustable projection angle
- Rain cover is separately available
- LED Qty.: 12 X RGB
- Input Voltage (battery charger): 100~240 VA, 50/60Hz
- Power consumption at full output: 45W
- Output (Lumens): 800+
- Lux@2m: 2200+
- Maximum projection distance: 20m
- Dimmer: 0-100%
- Strobe: 0-20Hz
- Beam angle: 16 degrees
- Battery storage: 24Ah
- Battery run time: 12 hours at full RGBA on
- Battery charging cycle: 12 hours
- Control: On-board: Display for Auto, Static color
- Control Protocol: DMX512 via wireless/ DMX512
- Control Personality: Tour, Arc1, Arc1+D, Arc1+S, HSV, Block (12CHS/ 3CHS/ 4CHS/ 5CHS/ 3CH/ 6CHS)
- Dimensions: 198,5 x 198,5 x 341,9 mm
- Weight: 14 Kg
- Housing: Stainless steel
- Lens Plate: Tempered glass
- Fixture Connection: Data in/out, Power in
- Cooling: Convection
- IP44(temporary event)
- Operation Temperature: -20°C ~50°C

**Note:** Knowledge of DMX is required to fully utilize this unit.

### Optional accessories

- 42719 Charger for Eventspot 1900 mkII
- 42718 Flightcase for Eventspot 1900 mkII
- 50231 Wireless DMX transmitter

## DMX Channel Summary

<b>TOUR</b>	<b>Channel</b>	<b>Description</b>
	1	Master Dimmer
	2	Module 1 red
	3	Module 1 green
	4	Module 1 blue
	5	Module 2 red
	6	Module 2 green
	7	Module 2 blue
	8	Color macro
	9	White
	10	Auto programs
	11	Auto speed adjustment
	12	Dimmer Speed

<b>ARC1</b>	<b>Channel</b>	<b>Description</b>
	1	Red
	2	Green
	3	Blue

<b>ARC1+D</b>	<b>Channel</b>	<b>Description</b>
	1	Master Dimmer
	2	Red
	3	Green
	4	Blue

<b>ARC1+S</b>	<b>Channel</b>	<b>Description</b>
	1	Master Dimmer
	2	Red
	3	Green
	4	Blue
	5	Strobe

<b>HSV</b>	<b>Channel</b>	<b>Description</b>
	1	Hue
	2	Saturation
	3	Value

<b>BLOCK</b>	<b>Channel</b>	<b>Description</b>
	1	Module 1 Red
	2	Module 1 Green
	3	Module 1 Blue
	4	Module 2 Red
	5	Module 2 Green
	6	Module 2 Blue



## Overview



Fig. 1

- 1) **Power on/off button + built in LED**  
Push and hold the power button for 3 seconds to switch the Eventspot 1900 mkII on or off. If the battery needs to be charged, the LED will start blinking. If the battery is empty, the LED will dim.
- 2) **40W RGBA LED**
- 3) **Wireless DMX receiver**
- 4) **Battery charger socket**
- 5) **Height adjustable foot**  
You change the height of this foot to change the operating position of the Eventspot (max angle 10°). See the next page.
- 6) **Power on/off switch**  
Use this switch to switch the Eventspot of if you're not using the Eventspot for more than 7 days.
- 7) **Power LED**
- 8) **Control panel**  
See page 13.
- 9) **Adjustable foot release handle**
- 10) **DMX signal connector (OUT) 3-pin**
- 11) **DMX signal connector (IN) 3-pin**

## Installation

Remove all packing materials from the Eventspot 1900 mkII. Check that all foam and plastic padding is removed. Connect all cables.

**Do not supply power before the whole system is set up and connected properly.**  
**Always disconnect from electric mains power supply before cleaning or servicing.**  
**Damages caused by non-observance are not subject to warranty.**

## Set Up and Operation

Before plugging the unit in, always make sure that the power supply matches the product specification voltage. Do not attempt to operate a 120V specification product on 230V power, or vice versa.

### Operating position

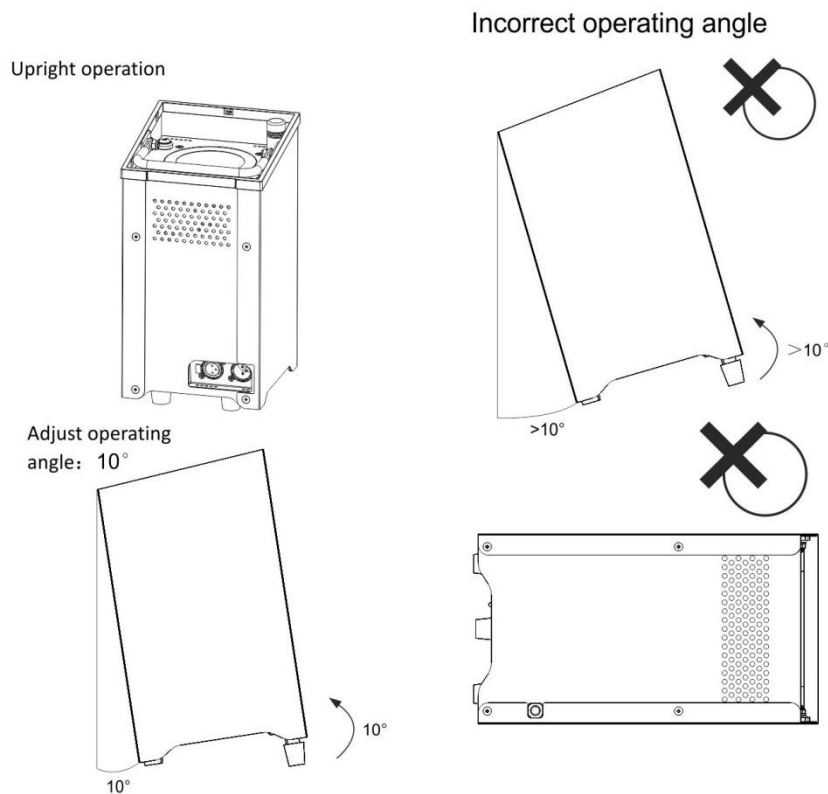

**Fig. 2**

## Charging the built in battery

1. In order to charge the battery, you need either the optional 42719, Charger for Eventspot 1900 mkII or the optional 42718 flightcase with built in chargers.
2. Turn off the **power on/off (6)** switch.
3. Place the Eventspot on the charger.
4. While the battery is charging, the red LED in the **power on/off (1)** button will light.
5. When the battery is fully charged, the red LED in the **power on/off (1)** button will dim.

### Important!

- Do not charge for more than 24 hours.
- Recharge within 3 days of use.
- When charging your Eventspot in the flightcase, make sure that the flightcase is open.
- Store with full load.
- Turn of the **power on/off (6)** switch at the rear when storing for more than 7 days.
- Store in an upright position.

## Fixture Linking

You will need a serial data link to run light shows of one or more fixtures using a DMX-512 controller or to run synchronized shows on two or more fixtures set to a master/slave operating mode. The combined number of channels required by all the fixtures on a serial data link determines the number of fixtures the data link can support.

The Eventspot 1900 mkII uses up to 15 channels.

**Important:** Fixtures on a serial data link must be daisy chained in one single line. To comply with the EIA-485 standard no more than 30 devices should be connected on one data link. Connecting more than 30 fixtures on one serial data link without the use of a DMX optically isolated splitter may result in deterioration of the digital DMX signal.



Maximum recommended DMX data link distance: 100 meters

Maximum recommended number of LED Pars on a DMX data link: 30 fixtures

@ 220V: 12 units may be connected in series

@120V: 6 units may be connected in series

## Data Cabling

To link fixtures together you must obtain data cables. You can purchase DAP Audio certified DMX cables directly from a dealer/distributor or construct your own cable. If you choose to create your own cable please use data-grade cables that can carry a high quality signal and are less prone to electromagnetic interference.

### DAP Audio Certified DMX Data Cables

- DAP Audio Basic microphone cable for allround use. bal. XLR/M 3 p. > XLR/F 3 p.  
**Ordercode:** FL01150 (1,5m.), FL013 (3m.), FL016 (6m.), FL0110 (10m.), FL0115 (15m.), FL0120 (20m.).
- DAP Audio cable for the demanding user with exceptional audio-qualities and connector made by Neutrik®. **Ordercode:** FL71150 (1,5m.), FL713 (3m.), FL716 (6m.), FL7110 (10m.).



## Control Modes

There are 3 modes:

- Select built-in programs
- Master/Slave
- DMX512

### One Eventspot 1900 mkII (Built-in Programs)

When the Eventspot 1900 mkII is not connected by a DMX-cable and Wireless DMX is switched off, it functions as a stand-alone device. See page 16/17 for more information about the built-in programs.

### Multiple Eventspots (Master/Slave control)

Use a 3-p XLR cable to connect the Eventspot 1900 mkII.  
The pins:



- 1. Earth
- 2. Signal -
- 3. Signal +

1. Link the units as shown in (Fig. 4), connect a DMX signal cable from the first unit's DMX "out" socket to the second unit's "in" socket. Repeat this process to link the second, third, and fourth units. You can use the same functions on the master device as described on page 16/17 (Built-in Programs). This means on the master device you can set your desired operation Mode and all slave devices will react the same as the master device.

### Multiple Eventspots (Master/Slave control)

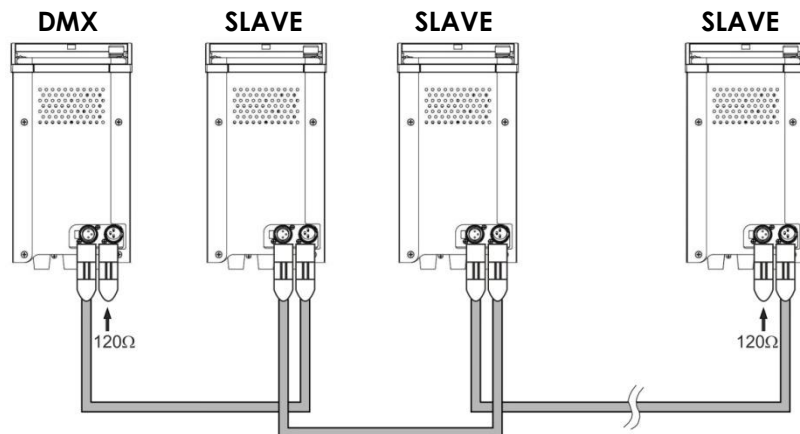

Fig. 4

### Multiple Eventspots (Wireless DMX Control)

Make sure, the Eventspot is in WDMX mode. See page 20 for more details.

### Multiple Eventspots (DMX Control)

Make sure, the Eventspot is not in WDMX mode. See page 20 for more details.  
Use a 3-p XLR cable to connect the Eventspot(s) and other devices.

### Occupation of the XLR-connection:

#### DMX-OUTPUT XLR mounting-socket:



- 1 - Ground
- 2 - Signal (-)
- 3 - Signal (+)

#### DMX-input XLR mounting-plug

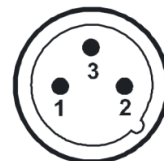

- 1 - Ground
- 2 - Signal (-)
- 3 - Signal (+)

## The transformation of the controller line of 3 pins and 5 pins (plug and socket)

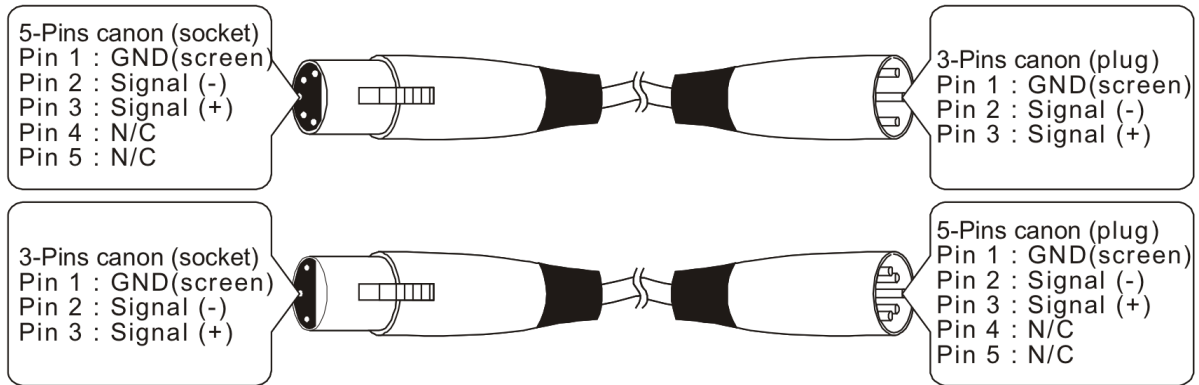

1. Link the units as shown in (figure 5), Connect a DMX signal cable from the first unit's DMX "out" socket to the second unit's "in" socket. Repeat this process to link the second, third, and fourth units.
2. Supply electric power: Plug electric mains power cords into each unit's IEC socket, then plug the other end of the mains power cord into proper electric power supply sockets, starting with the first unit. Do not supply power before the whole system is set up and connected properly.

## Multiple Eventspots DMX Set Up with individual DMX addressing

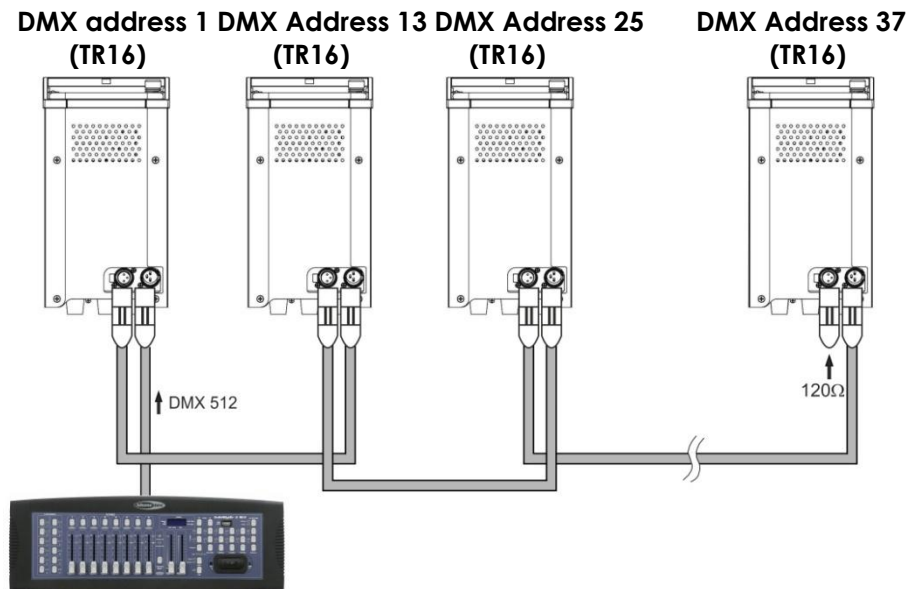

Fig. 5

**Note: Link all cables before connecting electric power**

The Eventspot 1900 mkII has a total of 9 DMX channel configurations, referred to as **Personalities**. The 9 personalities are [TOUR, ARC1, ARC1+D, ARC1+S, BLOCK]. Each of the different personalities can be accessed from the control panel.

## Control Panel

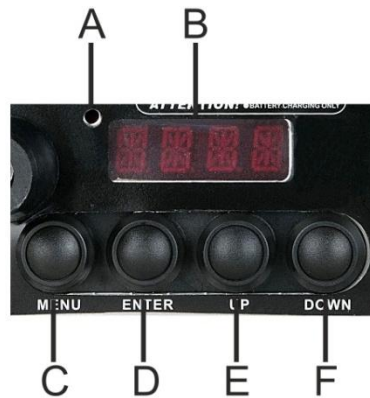

Fig. 6

- |                       |                 |
|-----------------------|-----------------|
| A. WDMX indicator LED | D. Enter Button |
| B. Display            | E. Up Button    |
| C. Menu Button        | F. Down Button  |

## DMX Control Mode

The fixtures are individually addressed on a data-link and connected to the controller. When a DMX signal is present, a “point” behind the last digit will blink. The fixtures respond to the DMX signal from the controller.

## DMX Addressing

The control panel on the front side of the base allows you to assign the DMX fixture address, which is the first channel from which the Eventspot 1900 mkII will respond to the controller. Please note when you use the controller, the unit has up to **12** channels (in TOUR mode). I.e.: When using multiple Eventspot 1900 mkII in **TOUR mode**, make sure you set the DMX addresses right. Therefore, the DMX address of the first Eventspot 1900 mkII should be **1(001)**; the DMX address of the second Eventspot 1900 mkII should be **1+12=13**; the DMX address of the third Eventspot 1900 mkII should be **13+12=25**, etc. Please, be sure that you don't have any overlapping channels in order to control each Eventspot 1900 mkII correctly. If two or more Eventspot 1900 mkII's are addressed similarly, they will work similarly.

**Controlling:** After having addressed all Eventspot 1900 mkII's, you may now start operating these via your lighting controller. **Note:** After switching on, the Eventspot 1900 mkII will automatically detect whether DMX 512 data is received or not. If there is no data received at the DMX-input, the “point” behind the last digit will dim. The problem may be:

- The XLR cable from the controller is not connected with the input of the Eventspot.
- The controller is switched off or defective, the cable or connector is defective, or the signal wires are swapped in the input connector.

**Note:** It's necessary to insert a XLR termination plug (with 120 Ohm) in the last fixture in order to ensure proper transmission on the DMX data link.

# Menu overview

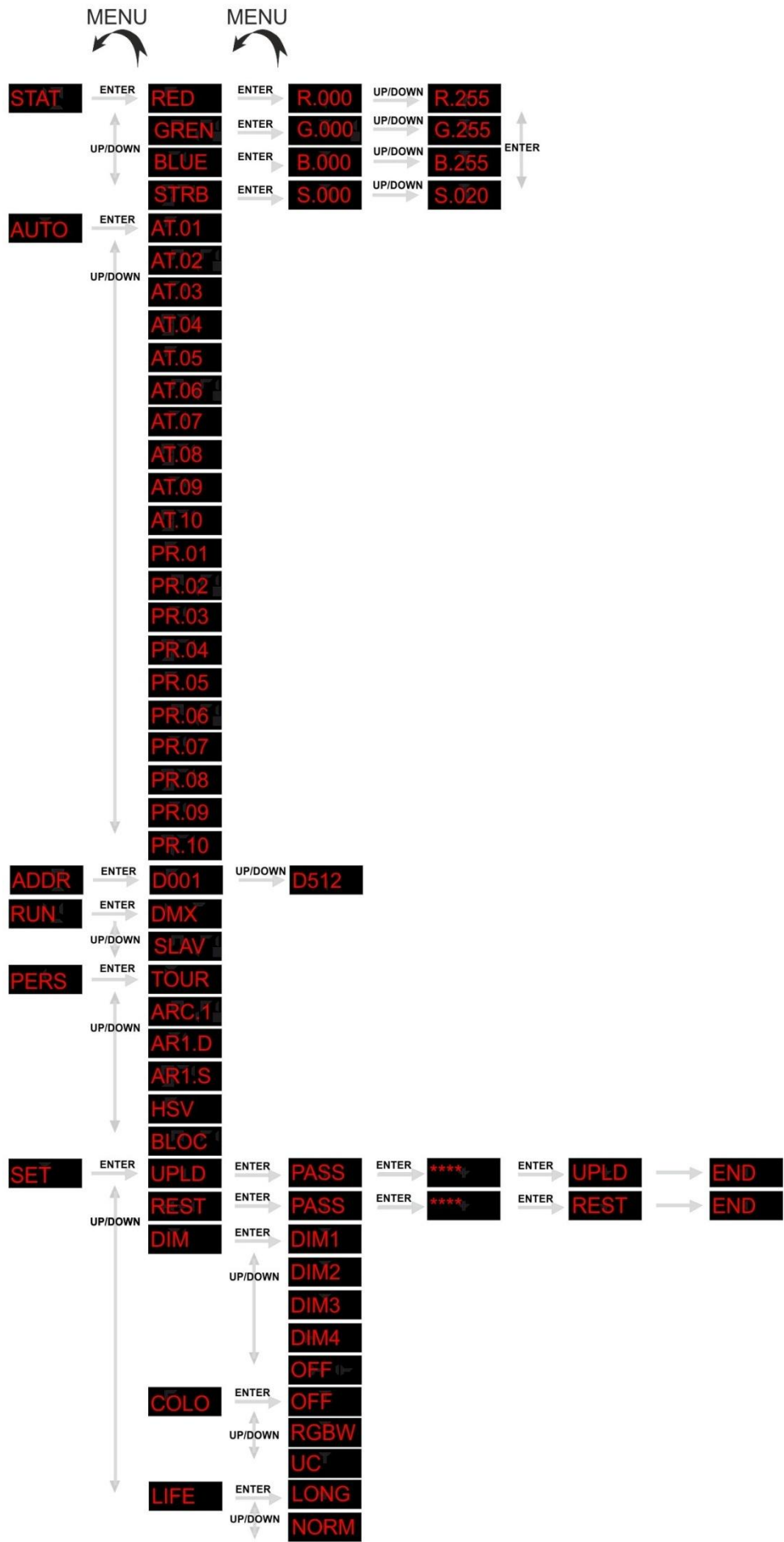

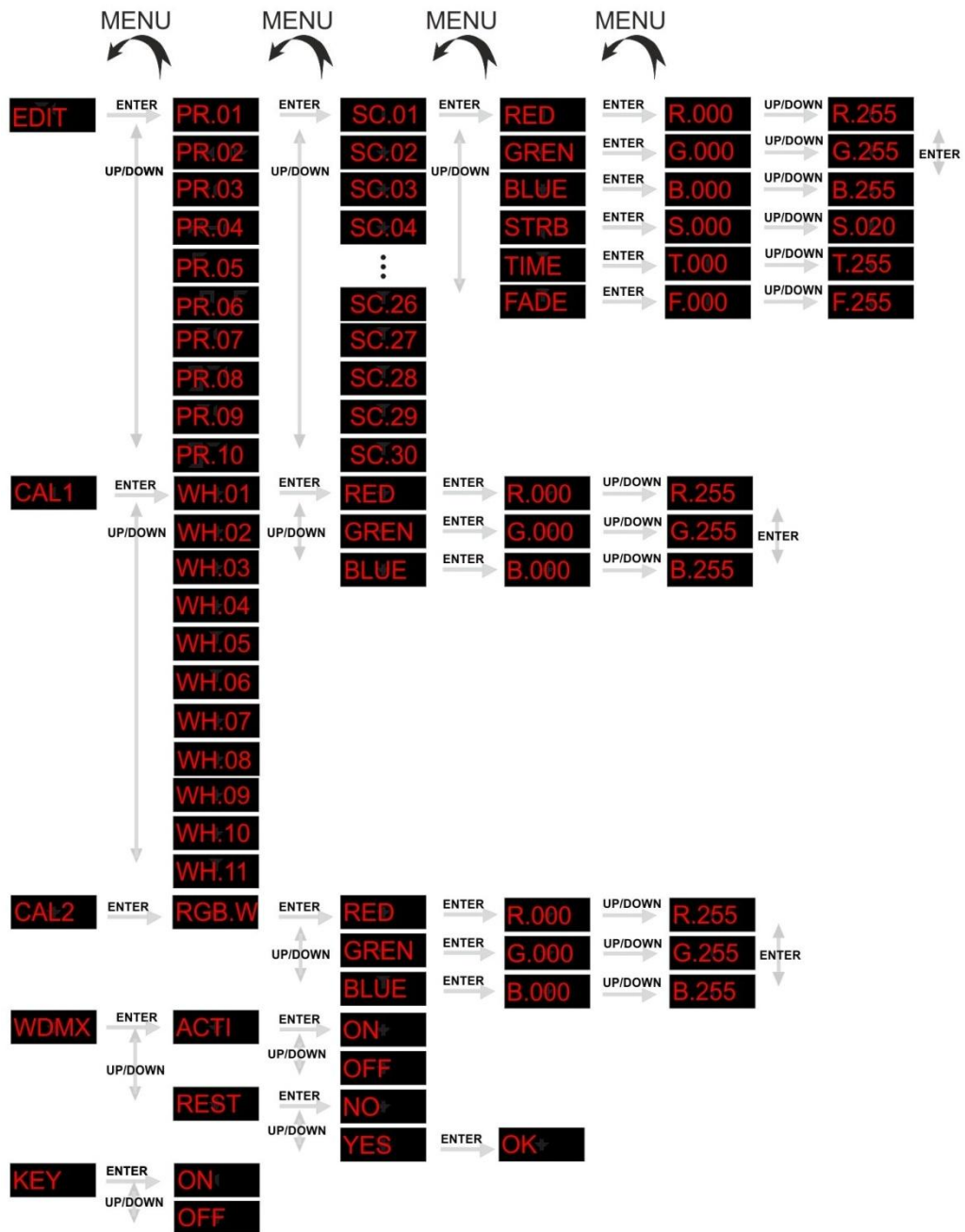



## Main Menu Options

Press the **up (E)/down (F)** buttons or the **menu (C)** button to navigate through the 11 menus:



### Creating a static color



1. Select the **STAT** menu and press the **enter (D)** button.
2. Use the **up (E)/down (F)** buttons you change the static colors (Red, Green, Blue, White or the strobe speed (0-20Hz).
3. Press the **menu (C)** button to go 1 step back.

You can combine RED, GREEN and BLUE to create an infinite range of colors (0-255).

#### Red

Set the value of the red LEDs (0-255).

#### Green

Set the value of the green LEDs (0-255).

#### Blue

Set the value of the blue LEDs (0-255).

#### Strobe

Set the value of the flash (0-20Hz).

## Activating an Auto Program

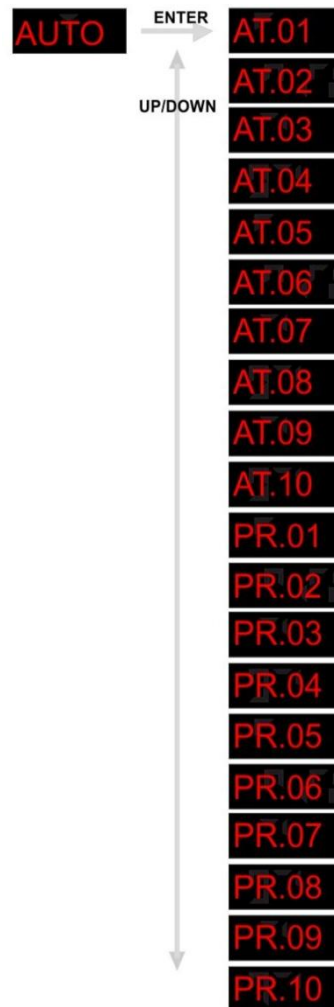

1. Select the **AUTO** menu and press the **enter (D)** button.
2. Use the **up (E)/ down (F)** buttons to select an auto program (AT.01-10) or a custom program (PR.01-10).
3. Press **enter (D)** after selecting the desired auto program. You can set up the auto speed of the 10 built-in programs between 000-255. You can also edit 10 custom programs.

## DMX 512 Address



1. Select the **ADDR** menu and press the **enter (D)** button.
2. Use the **up (E)/ down (F)** buttons to set the DMX address. You can choose your DMX address between 001-512.

## Run Mode



1. Select the **RUN** menu and press the **enter (D)** button.
2. Use the **up (E)/ down (F)** button to select the desired working mode:
  - DMX mode is used when working with a DMX512 controller to control the Eventspot or use the Eventspot as master during a Master –Slave operation.
  - SLAVE mode is for using the device as a slave during a Master-Slave operation.

**⚠ When the fixtures are in Auto program operation, the RUN MODE does not work. ⚠**

## Personality

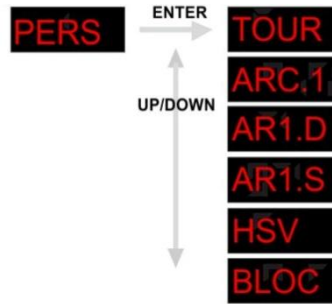

1. Select the **PERS** menu and press the **enter (D)** button.
2. Use the **up (E)/ down (F)** buttons to select a DMX mode:

<b>TOUR:</b>	12 channels
<b>ARC1:</b>	3 channels
<b>AR1+D:</b>	4 channels
<b>AR1+S:</b>	5 channels
<b>HSV:</b>	3 channels
<b>BLOCK</b>	6 channels

## Changing the Settings

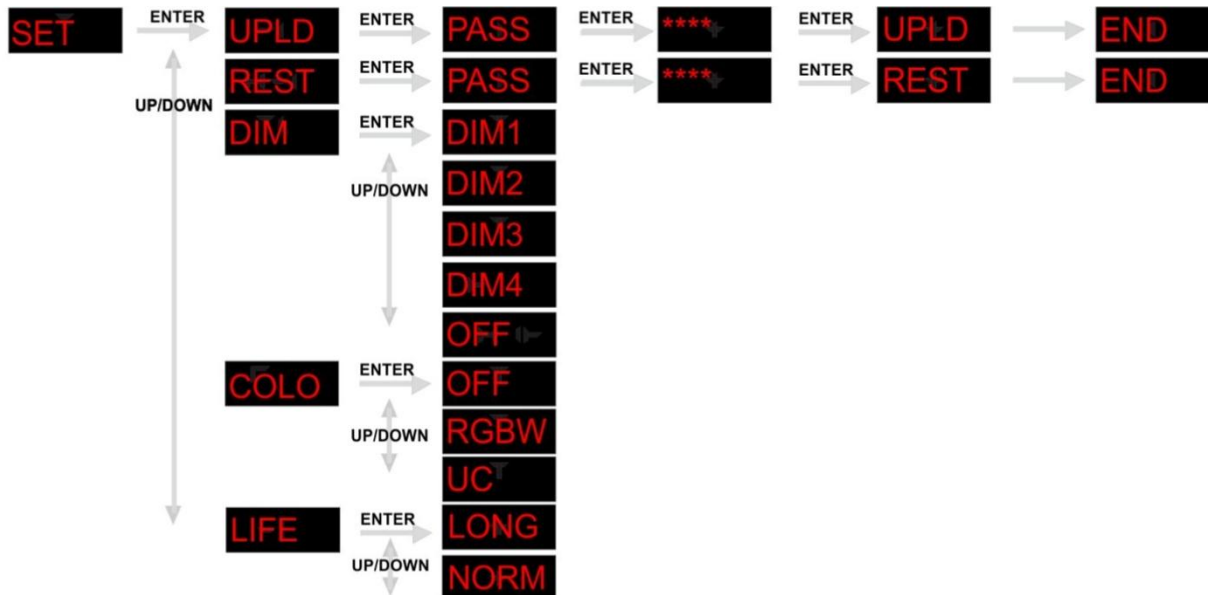

1. Select the **SET** menu and press the **enter (D)** button.

### Uploading a program from the current master device

2. Use the **up (E)/ down (F)** to select the **UPLD** menu in the master device.
3. Press the **enter (D)** button, now the display will show **PASS**.
4. Enter the password by pressing **up (E) -> down (F) -> up (E) -> down (F)**.
5. Press the **enter (D)** button to start uploading. While uploading, the display will show **SEND**.
6. When the system is finished uploading, the display will show **END**.

### Restoring to factory settings

7. Use the **up (E)/ down (F)** to select the **REST** menu.
8. Press the **enter (D)** button, now the display will show **PASS**.
9. Enter the password by pressing **up (E) -> down (F) -> up (E) -> down (F)**.
10. Press the **enter (D)** button to restore the device to the factory settings.
11. When the system is finished the display will show **END**.

### DIM mode setting

11. Use the **up (E)/ down (F)** to select the **DIMX** menu. Press the **enter (D)** button.

12. Use the **up (E)/ down (F)** to select **DIM1 - DIM4** or **OFF**:

When DMXW is set to **OFF**, the **RGBW** dimmer and the **master** dimmer are linear. **DIM1-4** are speed modes of the non linear dimmer. **DIM1** is the fastest and **DIM4** is the slowest. The **DIMX** setting has no effect in **TOUR** mode.

### Color setting

13. Use the **up (E)/ down (F)** to select the **COLO** menu. Press the **enter (D)** button.

14. Use the **up (E)/ down (F)** to select **OFF, RGBW, UC**:

**OFF:** On RGB = 255,255,255, the RGB values are not adjusted and the output is most powerful.

**RGBW:** On RGB = 255, 255, 255. The color is displayed as you have calibrated the specific color in menu **CAL2->RGBW**.

**UC:** RGB output is adjusted to a standard preset universal color. This way, different versions of Eventspot 1900 mkII's are color balanced to match each other.

### Battery life setting

15. Use the **up (E)/ down (F)** to select the **LIFE** menu. Press the **enter (D)** button.

16. Use the **up (E)/ down (F)** to select either **LONG** or **NORM** mode. Select **LONG** for an extended battery life of 12 hours or **NORM** for 10 hours of maximum power operation.

### Edit Custom



1. Select the **EDIT** menu and press the **enter (D)** button.
2. Use the **up (E)/ down (F)** to select a custom program for editing.
  - Each custom program has 30 steps, which can be edited.
  - Each step allows the creation of a scene using RED, GREEN, BLUE, STROBE, TIME & FADE.
3. Press the **enter (D)** button to edit a custom program.
4. Use the **enter (D)/ up (E)/ down (F)** buttons to edit each step.

## White Settings



1. Select the **CAL** menu and press the **enter (D)** button.
2. Enter the password by pressing **up (E) -> down (F) -> up (E) -> down (F) -> enter (D)**.
3. Use the **up (E)/ down (F)** to select the **CAL1** menu and press the **enter (D)** button.
4. Use the **up (E)/ down (F)** to select a white color from **WH.01 - WH11** (11 preset color temperatures).
4. Use the **up (E)/ down (F)** to select **RED, GREN** or **BLUE** and press the enter button.
5. Use the **up (E)/ down (F)** to edit the selected parameter.
6. Repeat step 3-5 until you have created the optimum white color.
7. The new white setting is automatically stored while leaving the menu.

## Making a custom white color



1. Select the **CAL2** menu and press the **enter (D)** button.
2. Enter the password by pressing **up (E) -> down (F) -> up (E) -> down (F) -> enter (D)**.
3. Use the **up (E)/ down (F)** to select the **CAL2** menu and press the **enter (D)** button.
4. Use the **up (E)/ down (F)** to select **RED, GREN** or **BLUE** and press the enter button.
5. Use the **up (E)/ down (F)** to edit the selected parameter.
6. Repeat step 3-5 until you have created the optimum white color.
7. The new white setting is automatically stored while leaving the menu.

Once you've edited one color, you are able to switch between R, G and B by pressing the enter (D) button.

## WDMX Settings

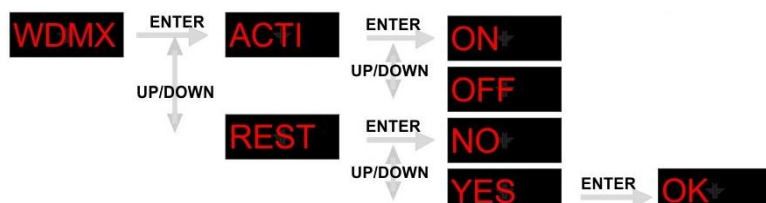

### Activating the wireless DMX

1. Select the **WDMX** menu and press the **enter (D)** button.
2. Use the **up (E)/ down (F)** to select the **ACTI** submenu and press the **enter (D)** button.
3. Use the **up (E)/ down (F)** to select **ON** in order to activate wireless DMX. Select **OFF** in order to deactivate wireless DMX.

### Reset the WDMX pairing

4. Use the **up (E)/ down (F)** to select the **REST** submenu and press the **enter (D)** button.
5. Use the **up (E)/ down (F)** to select **YES** in order to reset the DMX pairing. **Press enter (D)** to confirm. Select **NO** and press the **enter (D)** button to exit the reset mode.

### Keylock settings



1. Select the **KEY** menu and press the **enter (D)** button.

### Setting up the keylock

2. Use the **up (E)/ down (F)** to select the **key** menu. Press the **enter (D)** button.
3. Use the **up (E)/ down (F)** to switch the Keylock on or off. Press the **enter (D)** button. If no button is pressed for 1 minute, the system shuts down and can only be accessed by entering the password.

### Releasing the Keylock

4. Enter the password by pressing **up (E) -> down (F) -> up (E) -> down (F)**. Now switch the **power on/off (6)** switch off.
5. Start up the system by switching **power on/off (6)** switch on and pushing and holding the **power on/off (1)** button for 3 seconds.
6. Enter the **key** menu as described in step 1-2 and switch off the Keylock as described in step 3.

# DMX Channels

## DMX Control TOUR

Channel	Value	Function
1	000 – 255	<b>Dimmer</b> 0 – 100 %
2	000 – 255	<b>Module 1 red</b> 0 – 100 %; <b>CH2</b> will control the <b>STEP TIME</b> , if CH10 is set to custom 01-10 (only if CH10 141-255)
3	000 – 255	<b>Module 1 green</b> 0 – 100 %; <b>CH3</b> will control the <b>FADE TIME</b> , if CH10 is set to custom 01-10 (only if CH10 141-255)
4	000 – 255	<b>Module 1 blue</b> 0 – 100 %
5	000 – 255	<b>Module 2 red</b> 0 – 100 %
6	000 – 255	<b>Module 2 green</b> 0 – 100 %
7	000 – 255	<b>Module 2 blue</b> 0 – 100 %
8	000 – 010 011 – 030 031 – 050 051 – 070 071 – 090 091 – 110 111 – 130 131 – 150 151 – 170 171 – 200 201 – 205 206 – 210 211 – 215 216 – 220 221 – 225 226 – 230 231 – 235 236 – 240 241 – 245 246 – 250 251 – 255	<b>Macro Colors</b> No Function Red 100% / Green Up / Blue 0% Red Down / Green 100% / Blue 0% Red 0% / Green 100% / Blue Up Red 0% / Green Down / Blue 100% Red Up / Green 0% / Blue 100% Red 100% / Green 0% / Blue Down Red 100% / Green Up / Blue Up Red Down / Green Down / Blue 100% Red 100% / Green 100% / Blue 100% White 1: 3200K White 2: 3400K White 3: 4200K White 4: 4900K White 5: 5600K White 6: 5900K White 7: 6500K White 8: 7200K White 9: 8000K White 10: 8500K White 11: 10000K
9	000 – 009 010 – 255	<b>Strobe</b> No Function 1-20Hz
10	000 – 040 041 – 050 051 – 060 061 – 070 071 – 080 081 – 090 091 – 100 101 – 110 111 – 120 121 – 130 131 – 140 141 – 150 151 – 160 161 – 170 171 – 180 181 – 190 191 – 200 201 – 210 211 – 220 221 – 230 231 – 255	<b>Auto + Custom</b> No Function Auto 1 Auto 2 Auto 3 Auto 4 Auto 5 Auto 6 Auto 7 Auto 8 Auto 9 Auto 10 Custom 1 Custom 2 Custom 3 Custom 4 Custom 5 Custom 6 Custom 7 Custom 8 Custom 9 Custom 10

<b>11</b>	000 – 255	<b>Auto Speed.</b> CH11 will control the <b>Autospeed</b> , if CH10 is set to AUTO 1-AUTO 10 (only if CH10 061-140)
<b>12</b>	000 – 009 010 – 029 030 – 069 070 – 129 130 – 189 190 – 255	<b>Dimmer Speed.</b> Preset Dimmer Speed from Display Menu Linear Dimmer Non Linear Dimmer (fastest) 1 Non Linear Dimmer 2 Non Linear Dimmer 3 Non Linear Dimmer (slowest) 4

### MASTER DIMMER

- CH1 controls the intensity of the currently projected color.
- When the fader is at 255, the intensity of the output is at its maximum.

### RED, GREEN, BLUE, WHITE & AMBER SELECTION

- Channels 2, 3, 4, 5, 6 and 7 control the overall intensity of each respective color.
- Channels 2, 3, 4, 5, 6 and 7 can be combined to create an unlimited range of colors.

### COLOR MACROS & WHITE BALANCE

- Channel 8 selects the required COLOR MACRO and whites in different colors.
- Channel 8 has priority over channels 2, 3, 4, 5, 6 and 7.
- Channel 1 is used to control the intensity of the COLOR MACRO.

### STROBE

- CH9 is the strobe channel and controls the strobe effects of CH2, CH3, CH4, CH5 and CH6.
- The strobe has an adjustable speed with a maximum of 20Hz.

### AUTO

- Channel 10 selects the preset AUTO and CUSTOM programs (1-10).
- Channel 10 has priority over channels 2, 3, 4, 5, 6, 7, 9 and 10.
- When activating the custom AUTO programs 1-10, it is possible to control the **Step Time (CH2)** and **Fade Time (CH3)**.

### DIMMER SPEED

Enter DIM Mode (CH12) to select specific dimmer mode and dimmer speed. When DIMMER is set to OFF, then RGBW and the MASTER DIMMER are linear. Dim 1/2/3/4 are speed modes of the non linear dimmer. DIM1 is fastest, and DIM4 is slowest.

### DMX Control ARC1

Channel	Value	Function
<b>1</b>	000 – 255	<b>Red</b> 0 – 100 %
<b>2</b>	000 – 255	<b>Green</b> 0 – 100 %
<b>3</b>	000 – 255	<b>Blue</b> 0 – 100 %

### DMX Control ARC1+D

Channel	Value	Function
<b>1</b>	000 – 255	<b>Dimmer</b> 0 – 100 %
<b>2</b>	000 – 255	<b>Red</b> 0 – 100 %
<b>3</b>	000 – 255	<b>Green</b> 0 – 100 %
<b>4</b>	000 – 255	<b>Blue</b> 0 – 100 %



## DMX Control ARC1+S

Channel	Value	Function
1	000 – 255	<b>Dimmer</b> 0 – 100 %
2	000 – 255	<b>Red</b> 0 – 100 %
3	000 – 255	<b>Green</b> 0 – 100 %
4	000 – 255	<b>Blue</b> 0 – 100 %
5	000 – 255	<b>Strobe</b> 0 – 100 %

## DMX Control HSV

Channel	Value	Function
1	000 – 255	<b>Hue (Color variations)</b> 0 – 100 %
2	000 – 255	<b>Saturation of color Red</b> 0 – 100 %
3	000 – 255	<b>Value (Dimmer)</b> 0 – 100 %

## DMX Control BLOCK

Channel	Value	Function
1	000 – 255	<b>Module 1 red</b> 0 – 100 %
2	000 – 255	<b>Module 1 green</b> 0 – 100 %
3	000 – 255	<b>Module 1 blue</b> 0 – 100 %
4	000 – 255	<b>Module 2 red</b> 0 – 100 %
5	000 – 255	<b>Module 2 green</b> 0 – 100 %
6	000 – 255	<b>Module 2 blue</b> 0 – 100 %

## Maintenance

The Eventspot 1900 mkII requires almost no maintenance. However, you should keep the unit clean. Otherwise, the fixture's light-output will be significantly reduced. Switch of the **power on/off (6)** switch at the rear and then wipe the cover with a damp cloth. Wipe the front glass panel clean with glass cleaner and a soft cloth. Do not use alcohol or solvents. The front glass panel will require weekly cleaning, as smoke-fluid tends to build up residues, reducing the light-output very quickly. Do not immerse in liquid.

Keep connections clean. Disconnect electric power, and then wipe the DMX connections with a damp cloth. Make sure connections are thoroughly dry before linking equipment or supplying electric power.

## Troubleshooting

### No Light

This troubleshooting guide is meant to help solve simple problems.

If a problem occurs, carry out the steps below in sequence until a solution is found. Once the unit operates properly, do not carry out following steps.

If the light effect does not operate properly, refer servicing to a technician.

Response: Suspect two potential problem areas: the battery and the LED.

1. Battery. Check that the battery is fully charged. The red LED in the **power on/off (1)** button should light continuously if the Eventspot is active.

2. The LED. Return the Eventspot 1900 mkII to your Showtec dealer.
3. If all of the above appears to be O.K., switch the unit on again.
4. If you are unable to determine the cause of the problem, do not open the Eventspot 1900 mkII, as this may damage the unit and the warranty will become void.
5. Return the device to your Showtec dealer.

## No Response to DMX

Response: Suspect the DMX cable or connectors, a controller malfunction, a light effect DMX card malfunction.

1. Check the DMX setting. Make sure that DMX addresses are correct.
2. Check the DMX cable: Unplug the unit; change the DMX cable; then reconnect to electrical power. Try your DMX control again.
3. Determine whether the controller or light effect is at fault. Does the controller operate properly with other DMX products? If not, take the controller in for repair. If so, take the DMX cable and the light effect to a qualified technician.

See the table below for more problem solving.

Problem	Probable cause(s)	Remedy
One or more fixtures are completely dead.	No power to the fixture	<ul style="list-style-type: none"> <li>• Check that power is switched on and the battery is charged (red LED in <b>power on/off (1)</b> button should light continuously).</li> </ul>
Fixtures reset correctly, but all respond erratically or not at all to the controller.	The controller is not connected.	<ul style="list-style-type: none"> <li>• Connect controller.</li> </ul>
	3-pin XLR Out of the controller does not match XLR Out of the first fixture on the link (i.e. signal is reversed).	<ul style="list-style-type: none"> <li>• Install a phase reversing cable between the controller and the first fixture on the link.</li> </ul>
Fixtures reset correctly, but some respond erratically or not at all to the controller.	Poor data quality	<ul style="list-style-type: none"> <li>• Check data quality. If much lower than 100 percent, the problem may be a bad data link connection, poor quality or broken cables, missing termination plug, or a defective fixture disturbing the link.</li> </ul>
	Bad data link connection	<ul style="list-style-type: none"> <li>• Inspect connections and cables. Correct poor connections. Repair or replace damaged cables.</li> </ul>
	Data link not terminated with 120 Ohm termination plug.	<ul style="list-style-type: none"> <li>• Insert termination plug in output jack of the last fixture on the link.</li> </ul>
	Incorrect addressing of the fixtures.	<ul style="list-style-type: none"> <li>• Check address setting.</li> </ul>
	One of the fixtures is defective and disturbs data transmission on the link.	<ul style="list-style-type: none"> <li>• Bypass one fixture at a time until normal operation is regained: unplug both connectors and connect them directly together.</li> <li>• Have the defective fixture serviced by a qualified technician.</li> </ul>
	3-pin XLR Out on the fixtures does not match (pins 2 and 3 reversed).	<ul style="list-style-type: none"> <li>• Install a phase-reversing cable between the fixtures or swap pin 2 and 3 in the fixture that behaves erratically.</li> </ul>
No light	Fixture is too hot.	<ul style="list-style-type: none"> <li>• Allow fixture to cool.</li> <li>• Make sure air vents at control panel and front lens are not blocked.</li> <li>• Turn up the air conditioning.</li> </ul>
	LEDs damaged	<ul style="list-style-type: none"> <li>• Disconnect fixture and return to your dealer.</li> </ul>

# Product Specification

## Light Source

LED Quantity: 12 pieces 3-in-1 RGB LED

## Electrical

Input Voltage: 100~240 VAC...50/60Hz

Input voltage: 100-240V AC (For optional charger)

Powerconsumption: 45W (at full output)

## Output

Lumens: 800+

Lux (@2m): 2200+

Max Projection distance: 20m

Beam angle: 16 degrees

Dimmer: 0-100%

Strobe: 0-20Hz

## Battery

Type: Sealed Battery

Storage: 24 Ah.

Run time battery: 12 hours at full RGB on

Charging time battery: 12 hours Storage: 24Ah

## Control

On-board: Display for Auto, Static color

Control Protocol: DMX512 via wireless/ DMX512

Control Personality: Tour, Arc1, Arc1+D, Arc1+S, HSV, BLOCK  
(12CHS/3CHS/4CHS/5CHS/3CHS/6CHS)

## Physical

Housing: Stainless Steel, black anodized

IP Rating: IP-44

Operation temperature: -20 to +50 degrees

Dimensions: 199 x 199 x 361

Weight: 14kg

Cooling: Convection (no fans)



## Accessories

Optional flightcase: 42718

Optional charger: 42719

## Additional Features

LED display with password protection

## Minimum distance

Minimum distance from flammable surfaces: 0,5m

Minimum distance to lighted object: 1,3m

Max. ambient temperature  $t_a$ : 40°C; Max. housing temperature  $t_B$ : 80°C

Design and product specifications are subject to change without prior notice.



Website: [www.Showtec.info](http://www.Showtec.info)

Email: [service@highlite.nl](mailto:service@highlite.nl)



© 2013 Showtec.