

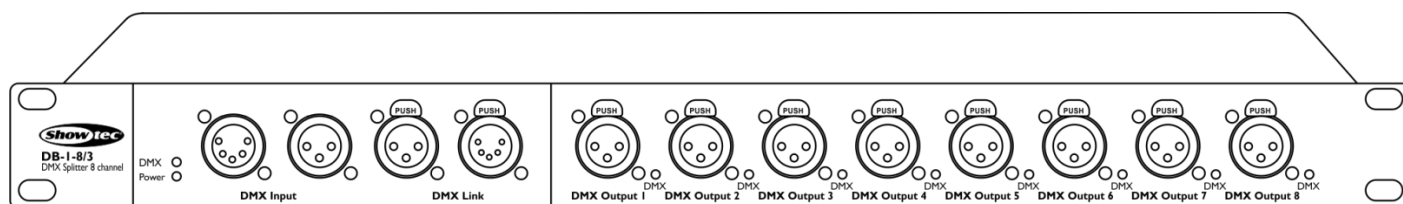

# MANUAL



ENGLISH

## DB-1-8

## V1

Ordercode: 50783

## Table of contents

---

<b>Warning</b> .....	2
Safety Instructions .....	2
Operating Determinations .....	4
Rigging .....	4
Connection with the mains.....	4
Return Procedure.....	5
Claims.....	5
<b>Description of the device</b> .....	6
Frontside.....	6
Backside .....	6
<b>Installation</b> .....	6
<b>Set Up and Operation</b> .....	7
Control Modes.....	7
Multiple DBs (DMX control) .....	7
Fixture Linking.....	8
Data Cabling.....	8
<b>Maintenance</b> .....	9
Replacing the Fuse .....	9
<b>Troubleshooting</b> .....	9
No Light .....	9
No Response to DMX.....	9
<b>Product Specification</b> .....	11
<b>Notes</b> .....	12

## Warning



**For your own safety, please read this user manual carefully  
before your initial start-up!**



### Unpacking Instructions

Immediately upon receiving this product, carefully unpack the carton and check the contents to ensure that all parts are present, and have been received in good condition. Notify the dealer immediately and retain packing material for inspection if any parts appear damaged from shipping or the carton itself shows signs of mishandling. Save the carton and all packing materials. In the event that a fixture must be returned to the factory, it is important that the fixture be returned in the original factory box and packing.

### Your shipment includes:

- DB-1-8 with Schuko power cable (1,5 m)
- User manual

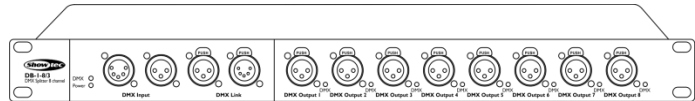

### CAUTION!

**Keep this device away from rain and moisture!  
Unplug mains lead before opening the housing!**



### Safety Instructions

Every person involved with the installation, operation and maintenance of this device has to:

- be qualified
- follow the instructions of this manual



**CAUTION! Be careful with your operations.  
With a dangerous voltage you can suffer  
a dangerous electric shock when touching the wires!**



Before your initial start-up, please make sure that there is no damage caused by transportation. Should there be any, consult your dealer and do not use the device.

To maintain perfect condition and to ensure a safe operation, it is absolutely necessary for the user to follow the safety instructions and warning notes written in this manual.

Please consider that damages caused by manual modifications to the device are not subject to warranty.

This device contains no user-serviceable parts. Refer servicing to qualified technicians only.

**IMPORTANT:**

The manufacturer will not accept liability for any resulting damages caused by the non-observance of this manual or any unauthorized modification to the device.

- Never let the power cord come into contact with other cables! Handle the power cord and all connections with the mains with particular caution!
- Never remove warning or informative labels from the unit.
- Never use anything to cover the ground contact.
- Never look directly into the light source.
- Never leave any cables lying around.
- Never use the device during thunderstorms, unplug the device immediately.
- Never leave various parts of the packaging (plastic bags, polystyrene foam, nails, etc.) within children's reach, as they are potential sources of danger.
- Do not insert objects into air vents.
- Do not open the device and do not modify the device.
- Do not connect this device to a dimmerpack.
- Do not shake the device. Avoid brute force when installing or operating the device.
- Do not switch the device on and off in short intervals, as this would reduce the system's life.
- Do not touch the device's housing bare-handed during its operation (housing becomes hot).
- Only use device indoor, avoid contact with water or other liquids.
- Only operate the device after having familiarized with its functions.
- Only install the device with the hanging-bracket.
- Avoid flames and do not put close to flammable liquids or gases.
- Always keep case closed while operating.
- Always allow free air space of at least 50 cm around the unit for ventilation.
- Always disconnect power from the mains, when device is not used or before cleaning! Only handle the power cord by the plug. Never pull out the plug by tugging the power cord.
- Make sure that the device is not exposed to extreme heat, moisture or dust.
- Make sure that the available voltage is not higher than stated on the rear panel.
- Make sure that the power cord is never crimped or damaged. Check the device and the power cord from time to time.
- Make sure that no side forces can impact on the truss system.
- The cable insert or the female part in the device must never be strained. There must always be sufficient cable to the device. Otherwise, the cable may be damaged which may lead to deadly electrical shocks.
- If the external cable is damaged, it has to be replaced by a qualified technician.
- If the lens is obviously damaged, it has to be replaced. So that its functions are not impaired, due to cracks or deep scratches.
- If device is dropped or struck, disconnect mains power supply immediately. Have a qualified engineer inspect for safety before operating.
- If the device has been exposed to drastic temperature fluctuation (e.g. after transportation), do not switch it on immediately. The arising condensation water might damage your device. Leave the device switched off until it has reached room temperature.
- If your Showtec device fails to work properly, discontinue use immediately. Pack the unit securely (preferably in the original packing material), and return it to your Showtec dealer for service.
- For adult use only. The device must be installed out of the reach of children. Never leave the unit running unattended.
- For replacement use fuses of same type and rating only.
- The user is responsible for correct positioning and operating of the DB-1-8. The manufacturer will not accept liability for damages caused by the misuse or incorrect installation of this device.
- This device falls under protection class I. Therefore it is essential to connect the yellow/green conductor to earth.
- Repairs, servicing and electric connection must be carried out by a qualified technician.
- WARRANTY: Till one year after date of purchase.

## Operating Determinations

- This device is not designed for permanent operation. Consistent operation breaks will ensure that the device will serve you for a long time without defects.
- The minimum distance between light output and the illuminated surface must be bigger than 0.5 meter.
- The maximum ambient temperature  $t_a = 40^{\circ}\text{C}$  must never be exceeded.
- The relative humidity must not exceed 50 % with an ambient temperature of  $40^{\circ}\text{C}$ .
- If this device is operated in any other way, than the one described in this manual, the product may suffer damages and the warranty becomes void.
- Any other operation may lead to dangers like short-circuit, burns, electric shock, crash, etc.

*You endanger your own safety and the safety of others!*

## Rigging

Please follow the European and national guidelines concerning rigging, trussing and all other safety issues.

Do not attempt the installation yourself !

Always let the installation be carried out by an authorized dealer !

## Procedure:

- If the DB-1-8 is lowered from the ceiling or high joists, professional trussing systems have to be used.
- Use a clamp to mount the DB-1-8, with the mounting bracket, to the trussing system.
- The DB-1-8 must never be fixed swinging freely in the room.
- The installation must always be secured with a safety attachment, e.g. an appropriate safety net or safety cable.
- When rigging, derigging or servicing the device, always make sure, that the area below the installation place is blocked and staying in the area is forbidden.

*Improper installation can cause serious damage to people and property !*

## Connection with the mains

Connect the device to the mains with the power-plug.

Always check if the right color cable is connected to the right place.

International	EU Cable	UK Cable	US Cable	Pin
L	BROWN	RED	YELLOW/COPPER	PHASE
N	BLUE	BLACK	SILVER	NEUTRAL
	YELLOW/GREEN	GREEN	GREEN	PROTECTIVE GROUND

*Make sure that the device is always properly connected to the earth!*

*Improper installation can cause serious injuries and/or damage of property!*



### Return Procedure



Returned merchandise must be sent prepaid and in the original packing, call tags will not be issued. Package must be clearly labeled with a Return Authorization Number (RMA number). Products returned without an RMA number will be refused. Highlite will not accept the returned goods or any responsibility. Call Highlite 0031-455667723 or mail [aftersales@highlite.nl](mailto:aftersales@highlite.nl) and request an RMA prior to shipping the fixture. Be prepared to provide the model number, serial number and a brief description of the cause for the return. Be sure to properly pack fixture, any shipping damage resulting from inadequate packaging is the customer's responsibility. Highlite reserves the right to use its own discretion to repair or replace product(s). As a suggestion, proper UPS packing or double-boxing is always a safe method to use.

**Note: If you are given an RMA number, please include the following information on a piece of paper inside the box:**

- 01) Your name
- 02) Your address
- 03) Your phone number
- 04) A brief description of the symptoms

### Claims

The client has the obligation to check the delivered goods immediately upon delivery for any shortcomings and/or visible defects, or perform this check after our announcement that the goods are at their disposal. Damage incurred in shipping is the responsibility of the shipper; therefore the damage must be reported to the carrier upon receipt of merchandise.

It is the customer's responsibility to notify and submit claims with the shipper in the event that a fixture is damaged due to shipping. Transportation damage has to be reported to us within one day after receipt of the delivery.

Any return shipment has to be made post-paid at all times. Return shipments must be accompanied with a letter defining the reason for return shipment. Non-prepaid return shipments will be refused, unless otherwise agreed in writing.

Complaints against us must be made known in writing or by fax within 10 working days after receipt of the invoice. After this period complaints will not be handled anymore.

Complaints will only then be considered if the client has so far complied with all parts of the agreement, regardless of the agreement of which the obligation is resulting.

## Description of the device

### Features

The Showtec DB-1-8 is a universal DMX-512 optical distributor. It is designed to distribute the incoming DMX signal, in daisy chain configurations, into 8 separate outputs with an additional "thru" port.

- Input voltage: 240V AC, 50Hz
- Power consumption: 5W
- 8 DMX output channels
- Connections: 3-pin/5-pin DMX IN, 3-pin/5-pin DMX LINK (thru), 8 x 3-pin DMX OUT
- Fuse: F1AL/250V
- Dimensions: 483 x 134 x 44,5 mm (LxWxH)  
19" x 1 HE
- Weight: 2,5 kg

### Frontside

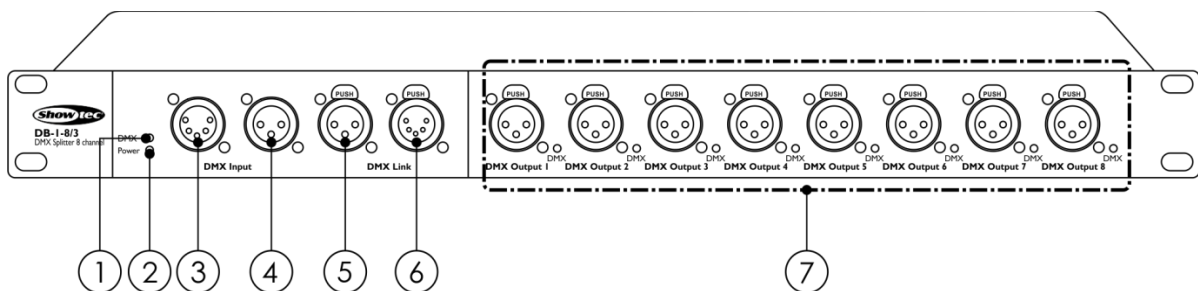

Fig. 01

- 01) DMX LED indicator
- 02) Power LED indicator
- 03) 5-pin DMX signal connector IN
- 04) 3-pin DMX signal connector IN
- 05) 3-pin DMX signal connector LINK (thru)
- 06) 5-pin DMX signal connector LINK (thru)
- 07) 3-pin DMX signal connectors OUT 1-8

### Backside

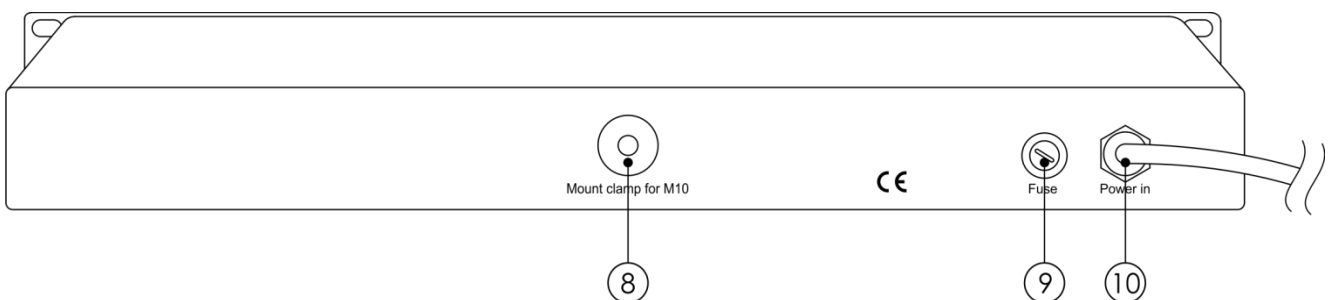

Fig. 02

- 08) M10 clamp thread
- 09) Fuse F1AL/250V
- 10) Schuko power cable 100-240V AC, 60/50 Hz

## Installation

Remove all packing materials from the DB-1-8. Check if all foam and plastic padding is removed. Connect all cables.

**Do not supply power before the whole system is set up and connected properly.**

**Always disconnect from electric mains power supply before cleaning or servicing.**

**Damages caused by non-observance are not subject to warranty.**

## Set Up and Operation

Follow the directions below, as they pertain to your preferred operation mode.  
 Before plugging the unit in, always make sure that the power supply matches the product specification voltage. Do not attempt to operate a 120V specification product on 230V power, or vice versa.  
 Connect the device to the main power supply.

### Control Modes

#### Multiple DBs (DMX control)

- 01) Fasten the distributor to a 19-inch rack.
- 02) Use a 3-pin/5-pin XLR cable to connect the DBs and other devices.

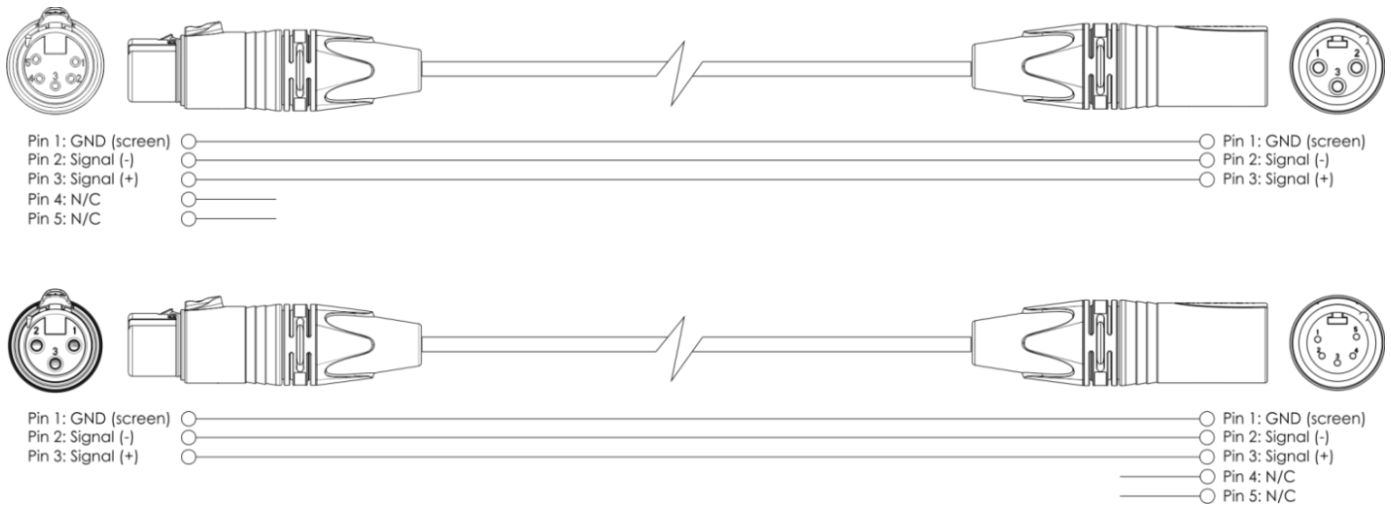

- 03) Connect the first unit's "in" socket to a light controller.
- 04) Link the units as shown in fig. 03. Connect the first unit's DMX "link" socket with the second unit's "in" socket, using a DMX signal cable. Repeat this process to link the second, third, and fourth units.
- 05) Connect light fixtures to the unit's DMX "out" sockets.
- 06) Supply electric power: Plug the unit's mains power cord into proper electric power supply sockets, starting with the first unit. Do not supply power before the whole system is set up and connected properly.

#### Multiple DBs DMX Set Up

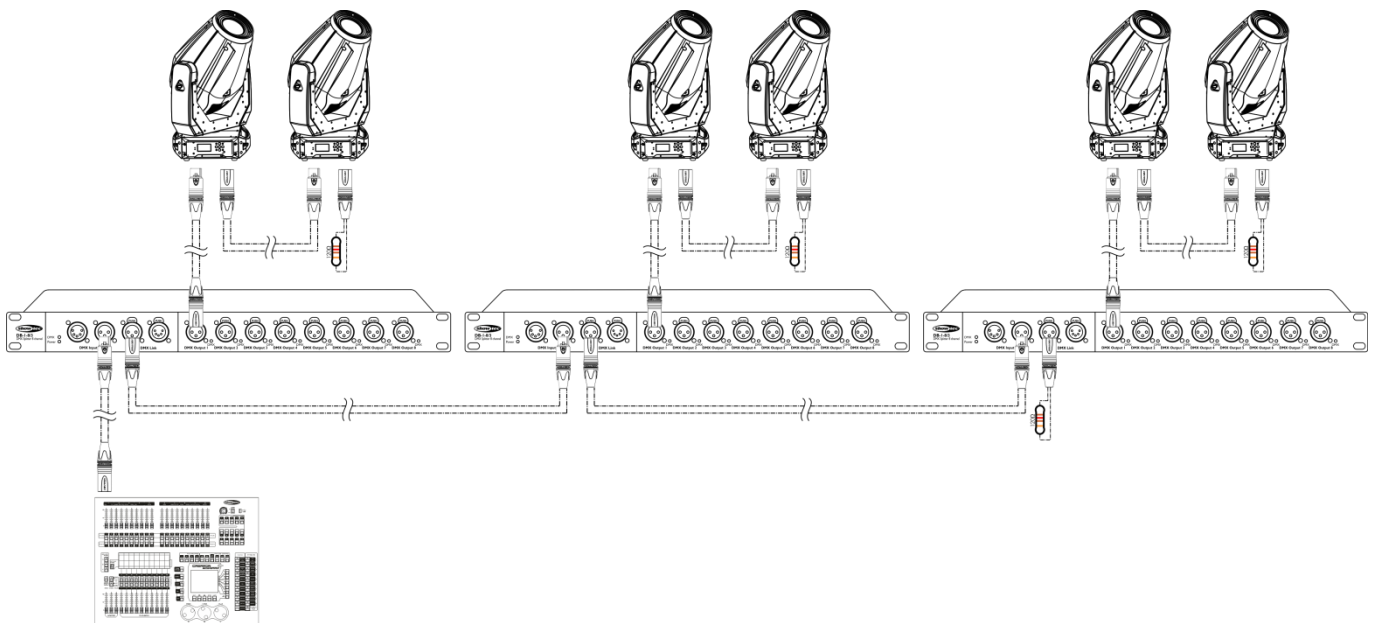

Fig. 03

Note : Link all cables before connecting electric power



## Fixture Linking

You will need a serial data link to run light shows of one or more fixtures using a DMX-512 controller or to run synchronized shows of two or more fixtures set to a master/slave operating mode. The combined number of channels required by all the fixtures on a serial data link determines the number of fixtures the data link can support.

**Important:** Fixtures on a serial data link must be daisy-chained in a single line. To comply with the EIA-485 standard, no more than 30 devices should be connected on one data link. Connecting more than 30 fixtures on one serial data link without the use of a DMX optically isolated splitter may result in deterioration of the digital DMX signal.



Maximum recommended DMX data link distance: 100 meters  
Maximum recommended number of fixtures on a DMX data link: 30 fixtures

## Data Cabling

To link fixtures together, you must obtain data cables. You can purchase DAP Audio certified DMX cables directly from a dealer/distributor or construct your own cable. If you choose to create your own cable, please use data-grade cables that can carry a high quality signal and are less prone to electromagnetic interference.

### DAP Audio DMX Data Cables

- DAP Audio Basic microphone cable for allround use. bal. XLR/M 3-pin > XLR/F 3-pin. **Ordercode** FL01150 (1,5 m), FL013 (3 m), FL016 (6 m), FL0110 (10 m), FL0115 (15 m), FL0120 (20 m).
- DAP Audio X-type data cable XLR/M 3-pin > XLR/F 3-pin. **Ordercode** FLX0175 (0,75 m), FLX01150 (1,5 m), FLX013 (3 m), FLX016 (6 m), FLX0110 (10 m).
- DAP Audio cable for the demanding user with exceptional audio-qualities and connector made by Neutrik®. **Ordercode** FL71150 (1,5 m), FL713 (3 m), FL716 (6 m), FL7110 (10 m).
- DAP Audio cable for the demanding user with exceptional audio-qualities and connector made by Neutrik®. **Ordercode** FL7275 (0,75 m), FL72150 (1,5 m), FL723 (3 m), FL726 (6 m), FL7210 (10 m).
- DAP Audio 110 Ohm cable with digital signal transmission. **Ordercode** FL0975 (0,75 m), FL09150 (1,5 m), FL093 (3 m), FL096 (6 m), FL0910 (10 m), FL0915 (15 m), FL0920 (20 m).

## Maintenance

---

The Showtec DB-1-8 requires almost no maintenance. However, you should keep the unit clean. Disconnect the mains power supply, and then wipe the cover with a damp cloth. Do not immerse in liquid. Do not use alcohol or solvents.

Keep connections clean. Disconnect electric power, and then wipe the DMX connections with a damp cloth. Make sure connections are thoroughly dry before linking equipment or supplying electric power.

### Replacing the Fuse

Power surges, short-circuit or inappropriate electrical power supply may cause a fuse to burn out. If the fuse burns out, the product will not function whatsoever. If this happens, follow the directions below:

- 01) Unplug the unit from electric power source.
- 02) Insert a flat-head screwdriver into a slot in the fuse cover. Turn the screwdriver to the left, at the same time gently push a bit (Turn and Push). The fuse will come out.
- 03) Remove the used fuse. If brown or unclear, it is burned out.
- 04) Insert the replacement fuse into the holder where the old fuse was. Reinsert the fuse cover. Be sure to use a fuse of the same type and specification. See the product specification label for details.

## Troubleshooting

---

### No Light

If the light effect does not operate properly, refer servicing to a technician.

Suspect three potential problem areas as: the power supply, the distributor, the fuse.

- 01) Power supply. Check that the unit is plugged into an appropriate power supply.
- 02) The distributor. Return the DB-1-8 to your Showtec dealer.
- 03) The fuse. Replace the fuse. See page 9 for replacing the fuse.
- 04) If all of the above appears to be O.K., plug the unit in again.
- 05) If you are unable to determine the cause of the problem, do not open the DB-1-8, as this may damage the unit and the warranty will become void.
- 06) Return the device to your Showtec dealer.

### No Response to DMX

Suspect the DMX cable or connectors, a distributor malfunction, a controller malfunction, a light effect DMX card malfunction.

- 01) Check the DMX setting. Make sure that DMX addresses are correct.
- 02) Check the DMX cable: Unplug the unit; change the DMX cable; then reconnect to electrical power. Try your DMX control again.
- 03) Determine whether the distributor, controller or light effect is at fault. If the distributor or controller does not operate properly, take the distributor or controller in for repair. Otherwise, take the DMX cable and the light effect to a qualified technician.

Symptom	Solution(s)	Applies to			
		Lights	Foggers & Snow	Controllers	Dimmers & Chaser
Auto shut off	Check fan thermal switch reset .	•			
Beam is very dim or not bright at all	Clean the optical system or replace a lamp.	•			
Breaker/Fuse keeps blowing	Check the total load placed on the device				•
Chase is too slow	Check the user manual for speed adjustment.	•		•	•
Device has no power	Check the mains power supply. Check the fuse. (internal and/or external)	•		•	•
Fixture is not responding	Check the DMX settings for correct addressing. Check all connected DMX cables. Check the polarity switch settings.	•			
Fixture is on, but there is no sound-controlled movement.	Make sure you have the correct audio mode on the control switches. If audio provided via 1/4" jack, make sure a live audio signal exists. Adjust the sound sensitivity control.	•		•	•
Fixtures reset correctly, but all respond erratically or not at all to the controller.	-The controller is not connected; please reconnect. -3-pin XLR Out of the controller does not match XLR Out of the first fixture on the link (i.e. signal is reversed). Install a phase reversing cable between the controller and the first fixture on the link - One of the fixtures is defective and disturbs data transmission on the link. Bypass one fixture at a time until normal operation is regained: unplug both connectors and connect them directly together Have the defective fixture serviced by a qualified technician			•	
Lamps cuts off sporadically	Possible bad lamp or the fixture is overheating. Lamp may be at the end of its life.	•			
Light will not come on after power failure	Some discharge lamps require a cooling off period ,before the electronics in the fixture can kick start it again. Wait 5 to 10 minutes before the lamp is cooled off and then power it up again.	•			
Loss of signal	Use only proper DMX cables. Install a 120Ω terminator on the last device. Note: Keep DMX cables separated from power cables or black lights.	•	•	•	•
No flash	Re-install the bulb, it may have shifted during shipping.	•			
No laser output	The bounce mirror motor may have shifted during shipping, readjust it accordingly.	•			
No light output	Install a new bulb. Fixture is too hot: -Allow fixture to cool. -Clean fan. -Make sure air vents at control panel and front lens are not blocked. -Turn up the air conditioning The power supply settings do not match local AC voltage and frequency. Disconnect fixture. Check settings and correct if necessary. Contact a technician for servicing, if the problem persists.	•			
Relay doesn't work	Check the reset switch. Check all cable connections.				•
Remote control does not work	Make sure the connector is firmly connected to the device.	•	•		

Stand alone mode	All Showtec lighting fixtures featuring stand-alone functions do not require additional settings, simply power up the fixture and it will automatically enter the stand-alone mode.	.			
------------------	---	---	--	--	--

## Product Specification

Model:	Showtec DB-1-8
Input voltage:	240V AC, 50Hz
Power consumption:	5W
Output channels:	8 channels
Control protocols:	DMX-512
Connections:	Schuko connector & 3-pin/5-pin XLR DMX IN/THRU, 8 x 3-pin XLR DMX OUT
Housing:	Metal & Flame-retardant plastic
Fuse:	F1A/250V
Dimensions:	483 x 134 x 44,5 mm (LxWxH) 19" x 1 HE
Weight:	2,5 kg

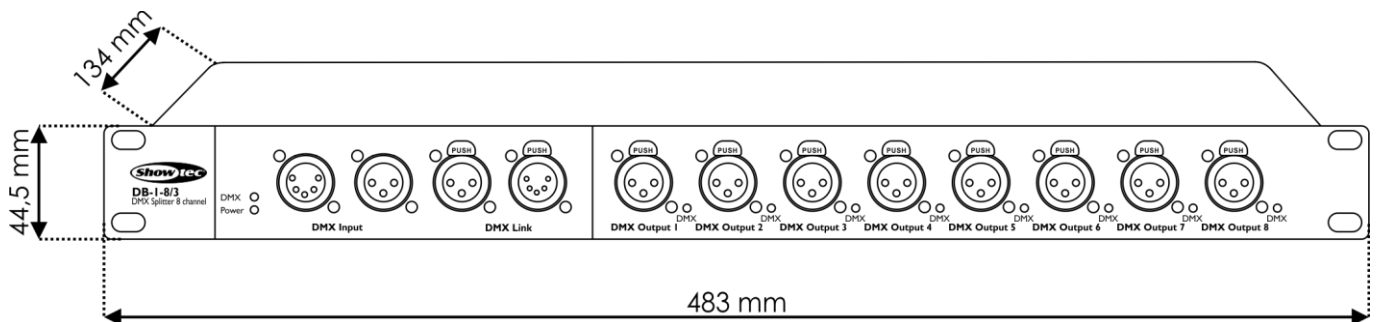

Design and product specifications are subject to change without prior notice.



Website: [www.Showtec.info](http://www.Showtec.info)  
 Email: [service@highlite.nl](mailto:service@highlite.nl)









©2015 Showtec