

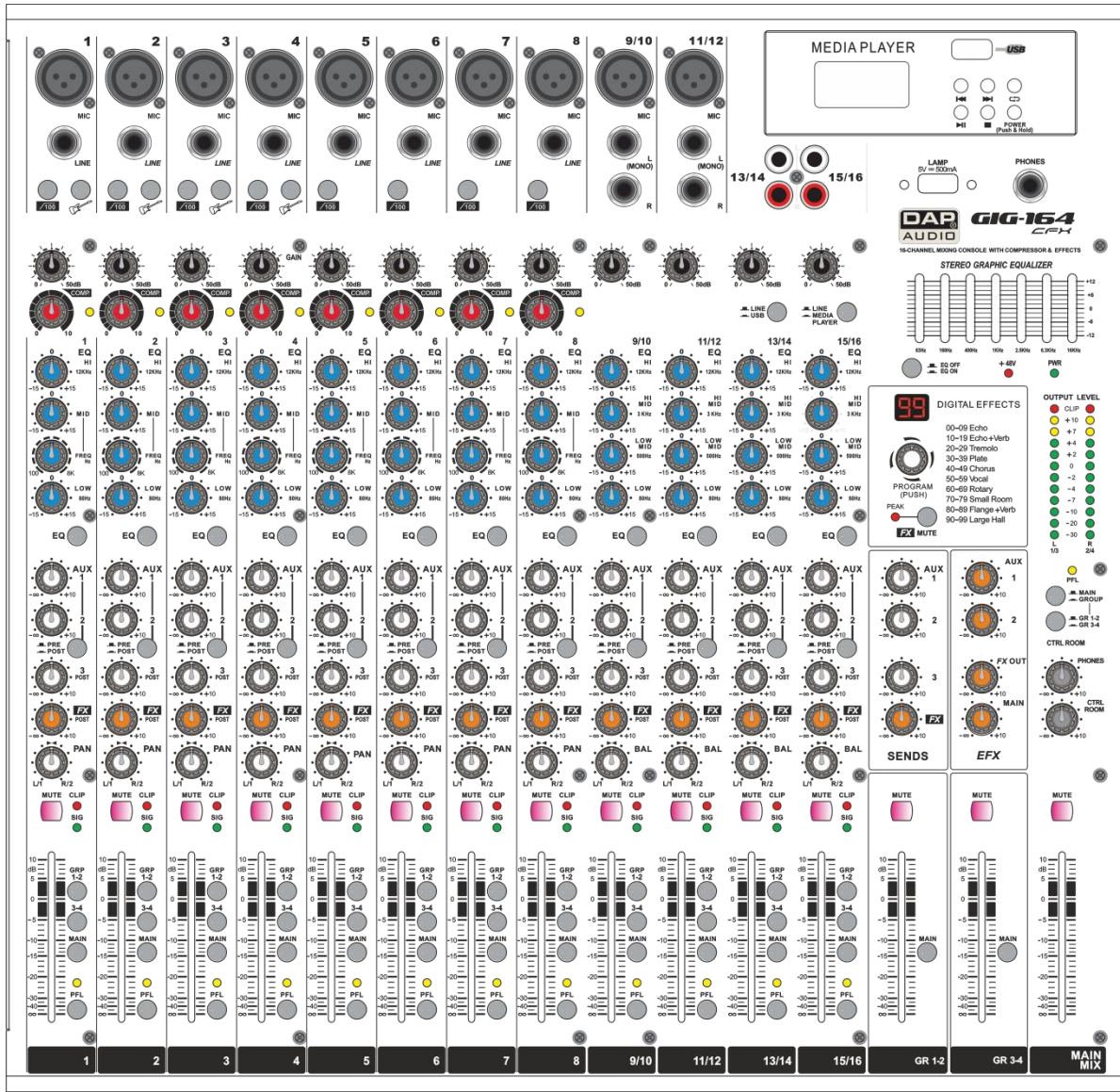

MANUAL



ENGLISH

GIG-164CFX

V1

Order code: D2287

Table of contents

Warning	2
Unpacking Instructions.....	2
Safety Instructions	2
Operating Determinations	4
Connection with the mains.....	4
Return Procedure.....	5
Claims.....	5
Description of the device	6
Features	6
Overview	6
Control Elements	7
Elements section 1	7
Elements section 2	8
Elements section 3	10
Elements section 4	11
Backside	14
Media player (Optional)	15
Installation	16
Set Up and Operation	16
Ready to start	16
Set up and connection	16
Connection Cables	17
Preset List GIG-164CFX	18
Maintenance	19
Replacing the Fuse.....	19
Troubleshooting	19
Product Specifications	19
Dimensions	21
Notes	22

Warning



**For your own safety, please read this user manual carefully
before your initial start-up!**



Unpacking Instructions

Immediately upon receiving this product, carefully unpack the carton and check the contents to ensure that all parts are present and have been received in good condition. Notify the dealer immediately and retain packing material for inspection if any parts appear damaged from shipping or the carton itself shows signs of mishandling. Save the carton and all packing materials. In the event that a fixture must be returned to the factory, it is important that the fixture be returned in the original factory box and packing.

Your shipment includes:

- GIG-164CFX mixing console
- 3-pin IEC power cable 1,5m
- User manual

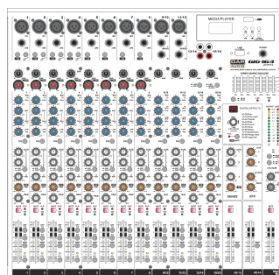

CAUTION!

**Keep this device away from rain and moisture!
Unplug mains lead before opening the housing!**



Safety Instructions

Every person involved with the installation, operation and maintenance of this system has to:

- be qualified
- follow the instructions of this manual



**CAUTION! Be careful with your operations.
With a dangerous voltage you can suffer
a dangerous electric shock when touching the wires!**



Before you initial start-up, please make sure that there is no damage caused by transportation. Should there be any, consult your dealer and do not use the system.

To maintain perfect condition and to ensure a safe operation, it is absolutely necessary for the user to follow the safety instructions and warning notes written in this manual.

Please consider that damages caused by manual modifications to the system are not subject to warranty.

This system contains no user-serviceable parts. Refer servicing to qualified technicians only.

IMPORTANT:

The manufacturer will not accept liability for any resulting damages caused by the non-observance of this manual or any unauthorized modification to the system.

- Never let the power-cord come into contact with other cables! Handle the power-cord and all connections with the mains with particular caution!
- Never remove warning or informative labels from the unit.
- Never use anything to cover the ground contact.
- Never leave any cables lying around.
- Do not insert objects into air vents.
- Do not connect this system to a dimmer pack.
- Do not switch the system on and off in short intervals, as this would reduce the system's life.
- Do not open the device and do not modify the device.
- Do not drive the inputs with a signal level bigger, than required to drive the equipment to full output.
- Do not plug Mics into the console (or stage box) while Phantom Power is on. Also mute the monitor / Pa system when turning Phantom Power on or off. Allow the system to adjust for a couple of seconds, before setting the input gains.
- Only use system indoor, avoid contact with water or other liquids.
- Avoid flames and do not put close to flammable liquids or gases.
- Always disconnect power from the mains, when system is not used. Only handle the power-cord by the plug. Never pull out the plug by tugging the power-cord.
- Always operate the unit with the AC ground wire connected to the electrical system ground.
- Make sure you don't use the wrong kind of cables or defective cables.
- Make sure that the signals into the mixer are balanced, otherwise hum could be created.
- Make sure you use DI boxes to balance unbalanced signals; All incoming signals should be clear.
- Make sure that the available voltage is not higher than stated on the rear panel.
- Make sure that the power-cord is never crimped or damaged. Check the system and the power-cord from time to time.
- Please turn off the power switch, when changing the power cord or signal cable, or select the input mode switch.
- Extreme frequency boosts in connection with a high input signal level may lead to overdriving your equipment. Should this occur, it is necessary to reduce the input signal level by using the INPUT control.
- To emphasize a frequency range, you don't necessarily have to move its respective control upward; try lowering surrounding frequency ranges instead. This way, you avoid causing the next piece of equipment in your sound path to overdrive. You also preserve valuable dynamic reserve ("headroom")
- Avoid ground loops! Always be sure to connect the power amps and the mixing console to the same electrical circuit to ensure the same phase!
- If system is dropped or struck, disconnect mains power supply immediately. Have a qualified engineer inspect for safety before operating.
- If the system has been exposed to drastic temperature fluctuation (e.g. after transportation), do not switch it on immediately. The arising condensation water might damage your system. Leave the system switched off until it has reached room temperature.
- If your Dap Audio device fails to work properly, discontinue use immediately. Pack the unit securely (preferably in the original packing material) and return it to your Dap Audio dealer for service.
- Repairs, servicing and electric connection must be carried out by a qualified technician.
- For replacement use fuses of same type and rating only.
- **WARRANTY:** Till one year after date of purchase.

Operating Determinations

This system is not designed for permanent operation. Consistent operation breaks will ensure that the system will serve you for a long time without defects.

If this system is operated in any other way, than the one described in this manual, the product may suffer damages and the warranty becomes void.

Any other operation may lead to dangers like short-circuit, burns, electric shock, etc.

You endanger your own safety and the safety of others!

Connection with the mains

Connect the device to the mains with the power-plug.

Always pay attention, that the right color cable is connected to the right place.

International	EU Cable	UK Cable	US Cable	Pin
L	BROWN	RED	YELLOW/COPPER	PHASE
N	BLUE	BLACK	SILVER	NEUTRAL
	YELLOW/GREEN	GREEN	GREEN	PROTECTIVE GROUND

Make sure that the device is always connected properly to the earth!

Improper installation can cause serious damage to people and property!





Return Procedure



Returned merchandise must be sent prepaid and in the original packing, call tags will not be issued. Package must be clearly labeled with a Return Authorization Number (RMA number). Products returned without an RMA number will be refused. Highlite will not accept the returned goods or any responsibility. Call Highlite 0031-455667723 or mail offersales@highlite.nl and request an RMA prior to shipping the fixture. Be prepared to provide the model number, serial number and a brief description of the cause for the return. Be sure to properly pack fixture, any shipping damage resulting from inadequate packaging is the customer's responsibility. Highlite reserves the right to use its own discretion to repair or replace product(s). As a suggestion, proper UPS packing or double-boxing is always a safe method to use.

Note: If you are given an RMA number, please include the following information on a piece of paper inside the box:

- 01) Your name
- 02) Your address
- 03) Your phone number
- 04) A brief description of the symptoms

Claims

The client has the obligation to check the delivered goods immediately upon delivery for any shortcomings and/or visible defects, or perform this check after our announcement that the goods are at their disposal. Damage incurred in shipping is the responsibility of the shipper; therefore the damage must be reported to the carrier upon receipt of merchandise.

It is the customer's responsibility to notify and submit claims with the shipper in the event that a fixture is damaged due to shipping. Transportation damage has to be reported to us within one day after receipt of the delivery.

Any return shipment has to be made post-paid at all times. Return shipments must be accompanied with a letter defining the reason for return shipment. Non-prepaid return shipments will be refused, unless otherwise agreed in writing.

Complaints against us must be made known in writing or by fax within 10 working days after receipt of the invoice. After this period complaints will not be handled anymore.

Complaints will only then be considered if the client has so far complied with all parts of the agreement, regardless of the agreement of which the obligation is resulting.

Description of the device

Features

The DAP GIG-164CFX is a professional compact mixer, which gives you great quality and better reliability than ever before. It is really ideal for gigs, recording and fixed PA installations.

- Ultra-low noise discrete MIC Preamps with +48V Phantom Power.
- 10 MIC Input Channels with XLR and 8 balanced Line Inputs.
- Insert I/O and Compressor control.
- Low Cut for MIC Input.
- 4 Auxiliary controls.
- Highly accurate 12-segment output level meter.
- 2 Stereo Input Channels with mono XLR Input and TRS Jack.
- 2 Stereo Input Channels with RCA Jack.
- 3-band EQ with sweepable MID and Clip LED on each MIC channel.
- 4-band EQ and Clip LED on Stereo channels.
- 4 AUX Send POST/PRE per channel for monitoring, external effects and internal effects.
- 4 AUX Send volume control.
- EFX return on AUX, MAIN and dedicated jack output.
- Mute and PFL function for each channel.
- 60mm Fader for level control.
- GR1-2, GR3-4 and Main L/R bus assign for each channel.
- Balanced XLR & TRS outputs for Main Mix.
- Built-in 24-bit DSP effect with 100 presets.
- USB-port to connect the GIG-164CFX to your PC/ laptop.
- Built-in Media player.
- Internal switch-mode power supply for maximum flexibility 100-240V.
- Fuse: T1,25AL/250V
- Dimensions: 500 x 435 x 91 mm (LxWxH)
- Weight: 6,75 kg

Overview

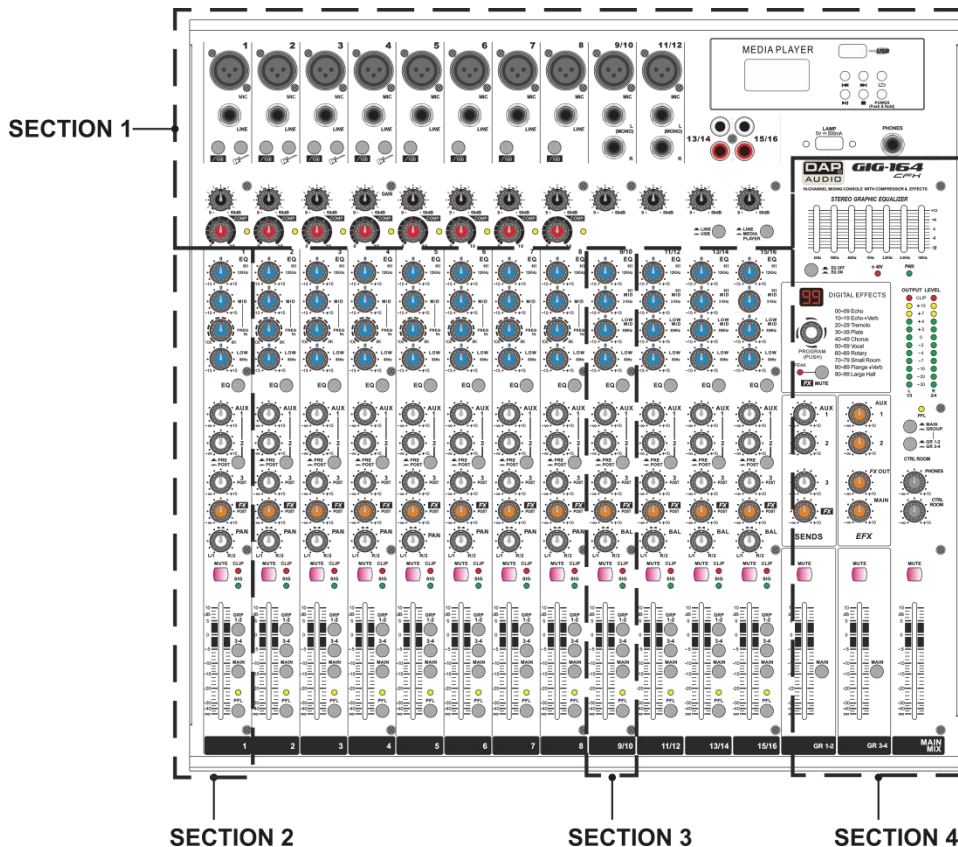

Control Elements

Elements section 1

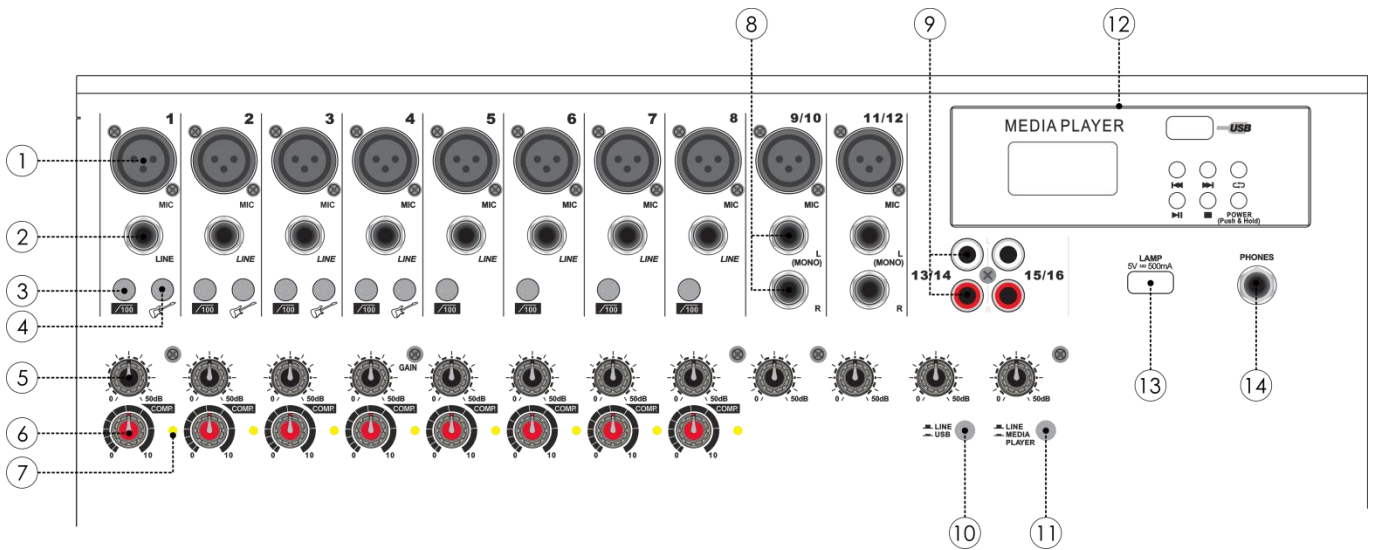

1. MIC INPUT JACKS (CHs 1 to 11/12)

Electronically balanced XLR-type inputs for connecting low-impedance microphones. The input provides extremely low noise and low hum signal processing. When connecting a microphone make sure that the pin assignment is correct. Always make sure to read the manual of the microphone you want to connect. The XLR-inputs are not suitable for connecting line level signals like an additional mixing console, FX-unit, etc. You have to use the LINE-inputs, when connecting this kind of equipment. The balanced XLR input can be connected to microphones, DI boxes and multicores.

2. LINE INPUT JACKS (CHs 1 to 8)

Electronically balanced inputs (1/4" jack connector) for connecting a keyboard, CD player, mixer, etc. You can connect balanced or unbalanced signal sources to the LINE input. Do not connect signal devices to a channel's MIC and LINE input at the same time. This will cause mutual interference, which results in level reduction.

3. LOW CUT

Press the LOW CUT switch to activate the high-pass filter which blends out low-frequency noise (100 Hz, 18 dB/octave). This function can be used to cut the humming sound or to prevent resonances of low frequencies, when the speakers are placed in close distance.

4. INSTRUMENT

Press this button to transform the input into an hi-impedance input. It can be used if you connect a guitar directly on the input.

5. GAIN CONTROL

With the GAIN control you can adjust the MIC or LINE input-sensitivity, while optimally matching the incoming signals to the mixer's internal operation level. Be sure to set this control fully counter-clockwise before you connect or disconnect a signal source to or from one of the inputs.

STEREO: The value range between 0 and +50 refers to the microphone input, indicating the degree of amplification applied to the input's signal.

6. COMPRESSOR CONTROL

Adjust the amount of compression applied to the channel. Turn the control to the right to increase the compression ratio and the output gain will automatically be adjusted. The result is smoother, even more dynamics, because louder signals are attenuated when the overall level is boosted.

7. LED INDICATOR COMPRESSOR

The LED indicator will light up when compressing.

8. LINE INPUT JACKS (CHs 9/10 and 11/12)

The stereo channels consist of two line inputs (1/4" jacks), one for the left and one for the right channel. The inputs are unbalanced (TS connectors). These channels can also be used as mono channels by connecting to the jack labeled "L" (left).

9. LINE INPUT RCA (CHs 13/14 and 15/16)

These are unbalanced stereo RCA pin jacks.

NOTE: Where an input channel provides both a MIC input jack and a LINE input jack or a LINE input jack and RCA pin jack, you can only use one pair of jacks at a time but not both pairs at the same time. Please connect to only one jack on each channel.

10. SWITCH LINE / USB

With this button you can switch the source of channel 13/14 between LINE or USB port.

11. SWITCH LINE/MEDIA PLAYER

With this button you can switch the source of channel 15/16 between LINE or Media player.

12. MEDIA PLAYER (Optional)

You can control the Media player with this section. For more information about the Media player see chapter "Media player" on page 15.

13. USB LAMP

This USB port provides 5V/500mA to connect a dash light.

14. PHONES

This is the PHONES output to plug in your headphones.

Elements section 2

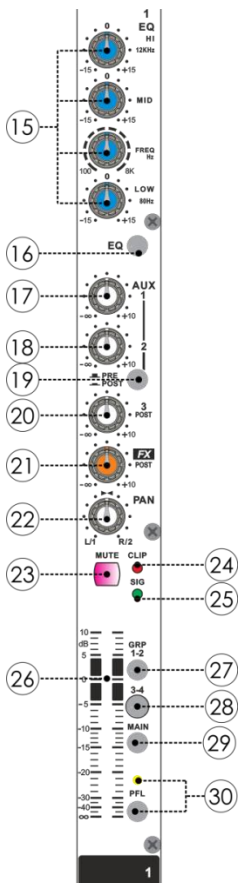

15. EQUALIZER**HI**

The high-frequency range is processed with a shelving filter above 12 kHz. You can boost or cut the bands up to 15 dB. In the center position (0 dB), the equalizer has a flat response.

MID

The mid control adjusts the mid frequency range. You can boost or cut the bands up to 15 dB. In the center position (0 dB), the equalizer has a flat response.

MID FREQUENCY

The control can be used to change the mid frequency from 100Hz – 8Khz.

LOW

The low-frequency range is processed with a shelving filter below 80 Hz. You can boost or cut the bands up to 15 dB. In the center position (0 dB), the equalizer has a flat response.

16. EQUALIZER BUTTON

Press this button to activate the channel equalizer.

17. AUX 1

The AUX bus is used as additional, flexible send path for various applications. The AUX control adjusts the volume level of the channel signal in the AUX 1 bus.

18. AUX 2

The AUX bus is used as additional, flexible send path for various applications. The AUX control adjusts the volume level of the channel signal in the AUX 2 bus.

19. PRE/POST BUTTON

Press the PRE/POST switch to change the routing of the AUX path from "post-fader" to "pre-fader." This way the volume level of the effects signal is not affected by the channel fader.

20. AUX 3 (POST)

The AUX bus is used as additional, flexible send path for various applications. The AUX control adjusts the volume level of the channel signal in the AUX 3 bus. This bus is post fader.

21. FX (POST)

The FX bus is used as a send path to the internal effect unit. The FX control adjusts the volume level of the channel signal to the effects unit. This bus is post fader.

22. PAN CONTROL.

By using the panorama control you can change the input signal's position within the stereo image. When the panorama control is set to center position, the audio signal is equal for both the left and right output.

23. MUTE

The MUTE switch mutes the channel. This means that the channel signal has been removed from the main mix and subgroups. At the same time the FX, monitor and AUX paths of the respective channel are muted as well. The corresponding mute LED indicates that the channel has been muted.

24. CLIP

The CLIP LED lights up as soon as the channel's level is too high. In this case, reduce the channel's input amplification with the gain control. The CLIP LED lights at a level of 3 dB below clipping.

25. SIGNAL LED

The signal indicator shows the presence of an audio signal at the output of the channel.

26. CHANNEL FADER

The channel fader adjusts the level of the channel signal as part of the main mix (or subgroup).

27. GROUP 1-2

Each channel is equipped with a GR1-2 switch, which allows you to feed multiple channels to a stereo mix down. The volume level can be adjusted using the GR1-2 LEVEL fader.

28. GROUP 3-4

Each channel is equipped with a GR3-4 switch, which allows you to feed multiple channels to a stereo mix down. The volume level can be adjusted using the GR3-4 LEVEL fader.

29. MAIN

Each channel is equipped with a MAIN switch, pressing this button will send the signal to the MAIN MIX bus.

30. PFL

Press the PFL switch to hear the signal on your headphones and simultaneously see it on the output level VU indication. The corresponding LED lights up when the function is activated.

Elements section 3

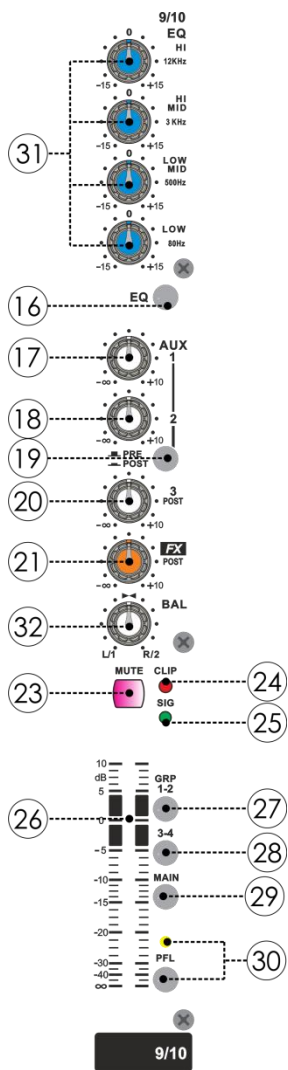

31. EQUALIZER

HI
The high-frequency range is processed with a shelving filter above 12 kHz. You can boost or cut the bands up to 15 dB. In the center position (0 dB), the equalizer has a flat response.

HI MID
The high mid control adjusts the high mid frequency range. This is a peak filter which boosts and cuts the frequencies centered at 3,0 kHz. You can boost or cut the bands up to 15 dB. In the center position (0 dB), the equalizer has a flat response.

LOW MID
The low mid control adjusts the low mid frequency range. This is a peak filter which boosts and cuts the frequencies centered at 500 Hz. You can boost or cut the bands up to 15 dB. When in center position (0 dB), the equalizer has a flat response.

LOW
The low-frequency range is processed with a shelving filter below 80 Hz. You can boost or cut the bands up to 15 dB. In the center position (0 dB), the equalizer has a flat response.

32. BALANCE CONTROL.

By using the balance control you can adjust the balance between the left and the right channel. If you use a mono source (input left mono) the control works as a panorama control and lets you change the input signal's position within the stereo image.

Elements section 4

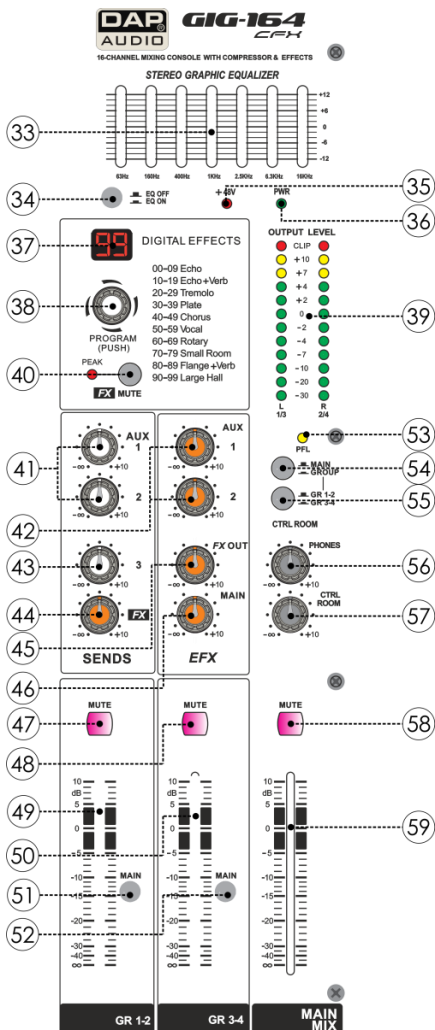

33. STEREO GRAPHIC EQUALIZER

This equalizer gives you up to 12 dB boost or cut at 63 Hz, 160 Hz, 400 Hz, 1 KHz, 2.5 KHz, 6.3 KHz and 16 KHz.

34. ACTIVATE STEREO GRAPHIC EQUALIZER

With this button you can activate the stereo graphic equalizer.

35. PHANTOM LED (+48V)

This LED lights up when the phantom power is switched on for the microphone inputs.

36. POWER LED

This LED lights up when the power is switched on.

37. DIGITAL EFFECTS

It displays the selected preset.

38. PROGRAM(PUSH)

Turn this knob to select the desired effect. There are 100 options: Echo, Vocal, Plate and versatile two-effect combination. Press the button to activate the chosen effect.

39. OUTPUT LEVEL VU INDICATOR

This stereo 12 segments LED meter will indicate the level of the overall output signal.

40. FX MUTE

Press this switch if you want to mute the signal from the internal effect.

NOTE: the effect can be turned on/off also by means of a footswitch connected to the FOOT SWITCH jack socket (68).

NOTE: If the peak LED flashes this means that the signal is too high, near to the clipping of the effect input stage. In this case, reduce the level of the AUX 4 / FX CHANNEL (sends) or AUX 4 / FX MASTER.

41. AUX1/AUX2 (SENDS)

The master AUX send control adjusts the signal volume level of the respective AUX send connector. This way you adjust the sum of the AUX signal on the input channels.

42. AUX1/AUX2 (EFX)

It adjusts the level of the internal effect signal sent to the AUX 1 and AUX 2 output.

43. AUX3

The master AUX send control adjusts the signal volume level of the respective AUX send connector. This way you adjust the sum of the AUX signal on the input channels.

44. AUX4/FX CHANNEL (SENDS)

This is the master FX control for adjusting the volume of all FX send signals at the input of the built-in effect processor.

45. FX OUT

It adjusts the level of the internal effect signal sent to the FX OUT OUTPUT (67).

46. AUX4/FX MASTER (EFX)

It adjusts the level of the internal effect signal sent to MAIN output.

47. MUTE GR 1-2

The MUTE switch mutes the output of group 1-2.

48. MUTE GR 3-4

The MUTE switch mutes the output of group 3-4.

49. CHANNEL FADER GROUP 1-2

Use this fader to control the output level of the subgroup mix.

50. CHANNEL FADER GROUP 3-4

Use this fader to control the output level of the subgroup mix.

51. MAIN GR 1-2

Pressing this button, the total signal from group 1-2 will send to the MAIN MIX bus.

52. MAIN GR 3-4

Pressing this button, the total signal from group 3-4 will send to the MAIN MIX bus.

53. PFL OVERALL

This LED will light up when a PFL button is pressed.

54. SWITCH MAIN/GROUP

If you press the MAIN MIX/GROUP button, the signal from GR1-2 or GR3-4 will be routed into the CONTROL ROOM output. Press the button again, the signal from MAIN MIX will be routed into the CONTROL ROOM output.

55. SWITCH GR 1-2 /GR 3-4

If you press the GR 1-2/GR 3-4 button, the signal from GR 3-4 will be routed into the CONTROL ROOM output. Press the button again, the signal from GR 1-2 will be routed into the CONTROL ROOM output.

56. PHONES

With the PHONES control you can adjust the volume level of all signals routed to the headphones. Depending on the type of headphones connected to the phones jack, the MAIN MIX is capable of producing very high output levels via the PHONES output. Therefore, make sure to turn the control all the way down (minimum setting) before connecting the headphones.

Warning: Listening to loud sound pressure levels over a longer period of time leads to hearing damage!

57. CONTROL ROOM

With the CONTROL ROOM knob you adjust the volume level of the CONTROL ROOM OUTPUTS (69).

58. MUTE MAIN MIX

The mute switch mutes the MAIN MIX output.

59. MAIN MIX LEVEL

Use this fader to control the output level of the MAIN MIX.

Backside

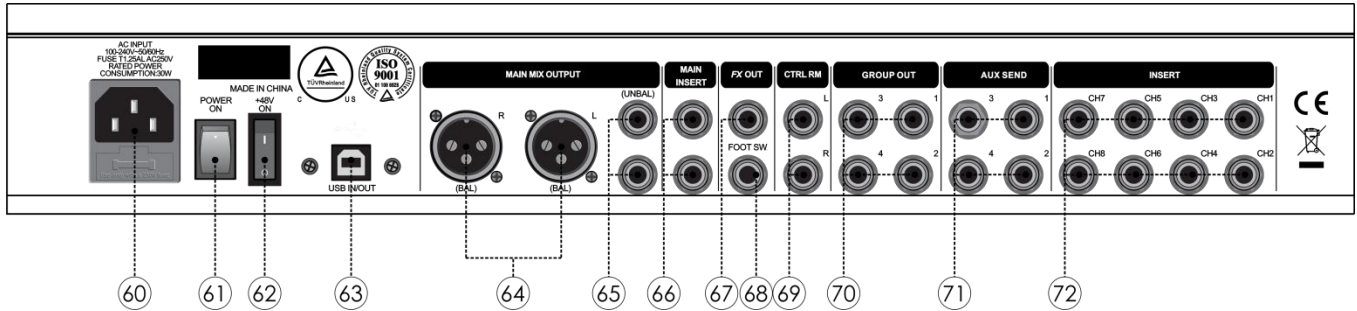
**60. IEC POWER INLET**

This connector is meant for the connection of the supplied main cord. Connect one end of the power cord to the connector, the other end to the mains, and then turn on the POWER (61) switch to operate the unit.

61. POWER ON/OFF

Do not supply power before the whole system is set up and connected properly.

62. +48V POWER SWITCH

Press this button to turn the phantom power +48V on. Do not connect any unbalanced microphones with the phantom power switched on. The red Phantom LED (35) will light if the phantom power is activated.

63. USB PORT

This USB port can be used to connect the GIG-164CFX to your PC/ laptop. You can use this connector for playback or record with your favorite media player.

64. MAIN MIX OUTPUT

Balanced XLR male connectors and provide the MAIN MIX signal.

65. STEREO (MAIN) OUTPUT

Unbalanced 1/4" stereo jacks and provide the MAIN MIX signal.

66. MAIN INSERT

This is where you connect serial effects before the MAIN MIX fader control. These serial effects usually are compressors or equalizers. The send signal is low-impedance, capable of driving any line-level device. The return signal is high impedance and can be driven by almost any device. Use dedicated "Y" cables to connect external effect devices.

67. FX OUT OUTPUT

The FX OUT OUTPUT provides the signal of the internal effects.

68. FOOT SWITCH

This socket is used to connect an external foot switch. It has the same function as the FX MUTE switch (40).

69. STEREO CONTROL ROOM OUTPUTS

The CONTROL ROOM OUTPUTS (unbalanced 1/4" stereo jacks) are used to send the signal to studio monitor speakers.

70. GR 1-2/3-4 OUT

The GR1-2 or GR 3-4 send outputs (unbalanced 1/4" stereo jacks) provide the signals of the GR 1-2 or GR 3-4 bus.

71. AUX SEND 1, 2, 3, 4







The AUX send outputs (unbalanced 1/4" stereo jacks) provides the signal of the AUX bus.

72. INSERT JACKS

The insert connectors (unbalanced 1/4" stereo jack connectors) are used to connect to external signal processors. You can connect a compressor, noise gate or equalizer to process the signal of a single channel.

Media player (Optional)

With this player you can play your MP3 files. The file system should be FAT16 or FAT32. This player can only decode MP3. It has a maximum of 7 sub folders.

- A USB port: Connect any USB memory stick.
- B  PRE: Press and hold this button to rewind or press this button to select a previous track.
- C  NEXT: Press and hold this button to go fast forward or press this button to skip to the next track.
- D  RPT: Press this button to repeat one track, one folder or all tracks.
Repeat All: Plays the complete content of the USB memory stick several times, the symbol on the screen is .
Repeat: Repeats a single track several times, the symbol on the screen is .
Play in order: play all the tracks in order, the symbol on the screen is blank.
Random play: All tracks will be played in random order, the symbol on the screen is A.
- E  PLAY / PAUSE: Press this button to start playback. Press once to start playback, twice to set the pause mode and again to resume playback.
- F  STOP: Press this button to stop playback.
- G POWER(Push & Hold): Press the power switch for 2-3 seconds, the module turns on.
- H DISPLAY: Look at the display to view all the USB player information.

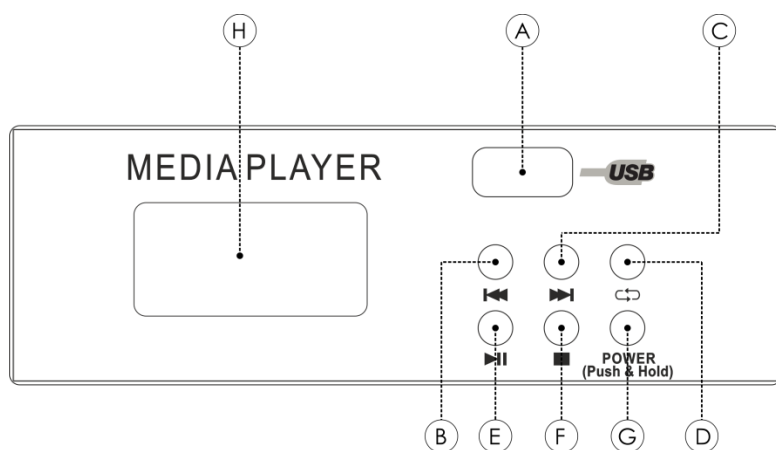

Installation

Remove all packing materials from the DIG-164CFX. Check if all foam and plastic padding is removed. Secure the equipment into a 19" rack if preferred. Connect all cables.

**Do not supply power before the whole system is set up and connected properly.
Always disconnect from electric mains power supply before cleaning or servicing.
Damages caused by non-observance are not subject to warranty.**

Set Up and Operation

Before plugging the unit in, always make sure that the power supply matches the product specification voltage. Do not attempt to operate a 115V specification product on 230V power, or vice versa.

Ready to start

- 01) Please check the available AC voltage in your country before connecting your mixer to the AC socket.
- 02) Be sure that the main power switch is turned off before connecting the mixer to the AC socket. You should also make sure that all input and output controls are turned down. This will avoid damage to your speakers and avoid excessive noise.
- 03) Always turn on the mixer before you turn on the power amplifier; turn off the mixer after the power amplifier is turned off.
- 04) Before connecting and disconnecting the unit from the power source, always turn off the unit.

Set up and connection

At this point you are in a position to successfully operate your GIG-164CFX Mixing Console. However, we advise you to carefully read the following section to be a real master of your own mixer. Not paying enough attention to the input signal level, to the routing of the signal and the assignment of the signal will result in unwanted distortion, a corrupted signal or no sound at all. So you should follow these procedures for every single channel:

- Before connecting mics or instruments, make sure that the power of all your system components, including the mixer, are turned off. Also, make sure that all the input and output controls are turned down. This will avoid damage to your speakers and avoid excessive noise.
- Properly connect all external devices such as mics, power amplifiers, speakers, effect processor, etc.
- First, turn on the power of any peripheral devices, then turn up the power of the mixer.
- Set the output level of your mixer or the connected power amplifier at no more than 75%.
- Set the CONTROL ROOM/PHONE level at no more than 50%.
- Position HI, MID and LOW EQ controls on center position.
- Position panoramic (PAN/BAL) control on center position.
- While speaking into the mic (or playing the instrument), adjust the channel level control so that the CLIP LED will occasionally blink, in this way you will maintain good headroom and dynamic range.
- You can shape the tone of each channel by adjusting the equalizer controls as desired.
- Now repeat the same sequence for all the input channels. The main LEDs can move up into the red section, in this case you can adjust the overall output level through the MAIN MIX control.

Connection Cables

Take care of your cables, always holding them by the connectors and avoiding knots and twists when coiling them: This gives the advantage of increasing their life and reliability. Periodically check your cables. A great number of problems (faulty contacts, ground hum, discharges, etc.) are caused entirely by using unsuitable or faulty cables.

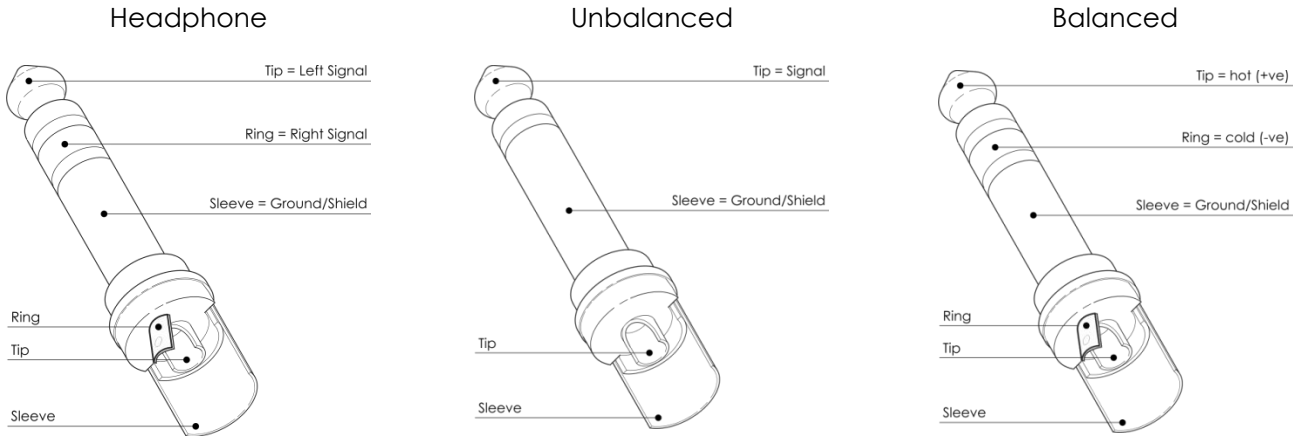

For these applications the unit provides 1/4" TRS and XLR connectors to easily interface with most professional audio devices. Follow the configuration examples below for your particular connection.

Unbalanced



Balanced

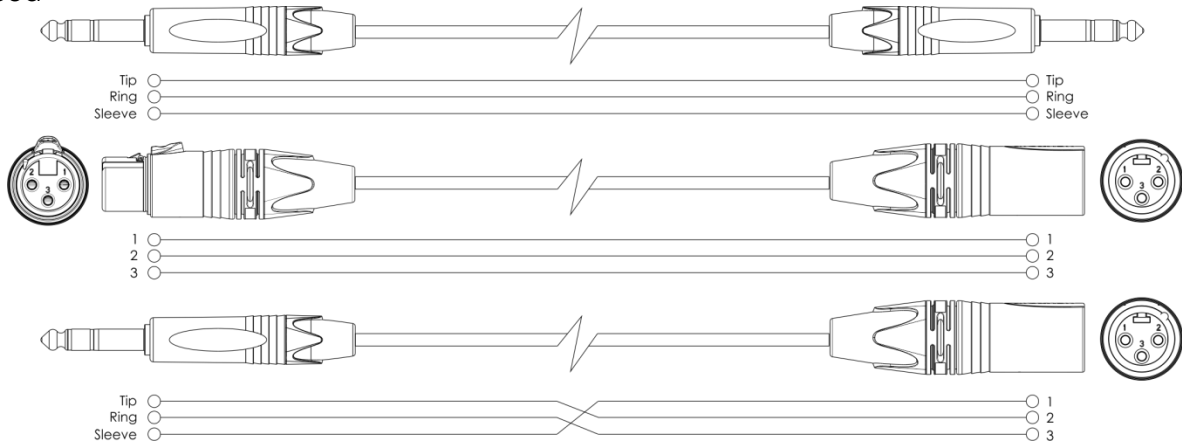

Presets List GIG-164CFX

No.	Preset	Description	Parameter
00~09	Echo	Reproduce the sound input on the output after a lapse of time or delay.	Delay Time: 145~205ms
10~19	Echo + Verb	Echo with Room effect.	Delay Time: 208~650ms Decay time: 1.7~2.1s
20~29	Tremolo	Amplitude modulation of the signal.	Rate: 0.6 Hz~5 Hz
30~39	Plate	Simulate the transducers sound like classic bright vocal plate.	Decay time: 0.9s~3.6s
40~49	Chorus	Recreate the illusion of more than one instrument from a single instrument sound.	Rate : 0.92Hz ~1.72Hz
50~59	Vocal	Simulate a small space with slight decay time.	Rev. decay time: 0.8~0.9s Pre-delay: 0~45ms
60~69	Rotary	Simulate the sound effect achieved by rotating horn speakers and a bass cylinder.	Modulation depth: 20%~80%
70~79	Small Room	Simulate a bright studio room.	Decay time: 0.7~2.1s Pre-delay: 20~45ms
80~89	Flanger + Verb	Simulate to play with another person carrying out the same notes on the same instrument and reverb.	Decay time: 1.5~2.9s Rate: 0.8Hz ~2.52Hz
90~99	Large Hall	Simulate a large acoustic space of the sound.	Decay time: 3.6~5.4s Pre-delay: 23~55ms



DIGITAL EFFECTS



**PROGRAM
(PUSH)**

PEAK



FX MUTE

- 00-09 Echo
- 10-19 Echo +Verb
- 20-29 Tremolo
- 30-39 Plate
- 40-49 Chorus
- 50-59 Vocal
- 60-69 Rotary
- 70-79 Small Room
- 80-89 Flange +Verb
- 90-99 Large Hall

Maintenance

The DAP GIG-164CFX requires almost no maintenance. However, you should keep the unit clean. Disconnect the mains power supply, and then wipe the cover with a damp cloth. Do not immerse in liquid. Do not use alcohol or solvents.

Keep connections clean. Disconnect electric power, and then wipe the audio connections with a damp cloth. Make sure connections are thoroughly dry before linking equipment or supplying electric power.

Replacing the Fuse

Power surges, short-circuit or inappropriate electrical power supply may cause a fuse to burn out. If the fuse burns out, the product will not function whatsoever. If this happens, follow the directions below.

- 01) Unplug the unit from electric power source.
- 02) Insert a screwdriver into the slot in the fuse cover. Gently pry up the fuse cover. The fuse will come out.
- 03) Remove the used fuse. If brown or unclear, it is burned out.
- 04) Insert the replacement fuse into the holder where the old fuse was. Reinsert the fuse cover. Be sure to use a fuse of the same type and specification. See the product specification label for details.

Troubleshooting

DAP GIG-164CFX

This troubleshooting guide is meant to help solve simple problems. If a problem occurs, carry out the steps below in sequence until a solution is found. Once the unit operates properly, do not carry out following steps.

- 01) If the device does not operate properly, unplug the device.
- 02) Check power from the wall, all cables, connections, etc.
- 03) Replace the fuse. See page 19 for replacing the fuse.
- 04) If all of the above appears to be O.K., plug the unit in again.
- 05) If nothing happens after 30 seconds, unplug the device.
- 06) Return the device to your DAP Audio dealer.

Product Specifications

Model:	DAP Audio GIG-164CFX
Power supply:	AC 100- 240V 50Hz/60Hz
Power connection:	IEC power connector
Rated power consumption:	30W
Fuse:	T1,25AL/250V
Dimensions:	500 x 435 x 91 mm (LxWxH)
Weight:	6,75 kg

Mono channels

Microphone input:	XLR balanced
Frequency response:	10Hz to 55KHz, +/-3dB
Distortion(THD+N):	<0.03% at +0dB ,22Hz~22KHz A-weighted
Gain range:	0dB to 50dB
Max. Input:	+15 dB
LOW CUT:	75Hz
SNR:	<-114dB A-weighted
Phantom power:	+48V with switch control
Line input:	1/4' TRS balanced
Frequency response:	10Hz to 55KHz, +/-3dB
Distortion(THD+N):	<0.03% at +0dB ,22Hz~22KHz A-weighted
Sensitivity range:	+15dB~ -35dB
COMPRESSOR:	GAIN:0~9dB THRESHOLD:20dB---> ↓5dB

Stereo input channels

Mic input:	XLR balanced
LOW CUT:	100Hz
Line input:	1/4" TRS or TRS/RCA un-balanced
Frequency response:	10Hz to 55KHz, +/-3dB
Distortion(THD+N):	<0.03% at +0dB ,22Hz~22KHz A-weighted
Sensitivity range:	-20dBu~ +20dBu
SNR:	<-100dB A-weighted
Phantom power:	+48V with switch control

Channels EQ

	mono channel	stereo channel
High:	+/-15dB@12KHz	+/-15dB@12KHz
Mid:	+/-15dB@100Hz-8KHz Sweepable	+/-15dB@3KHz +/-15dB@500Hz
Low:	+/-15dB@80Hz	+/-15dB@80Hz

Impedances

Microphone input:	1.8K Ω
All other input:	>10K Ω
All other outputs:	120 Ω

DSP section (options)

A/D and D/A converters:	24bit
Type of effects:	Echo ,Echo+Verb, Tremolo, Plate, Chorus, Vocal Rotary , Small Room , Flange + Verb , Large Hall
Controls:	Mute switch & Foot-switching with LED indicator 100 position preset selector(10 preset * 10 variation)
FOOT-SW:	TIP:FX SLEEVE:GND

Main mix section

Max. MAIN MIX output:	+22dBu XLR balanced (+16dBu un-balanced)
AUX range:	OFF to +10dB
Fader range:	OFF to +10dB
PHONES range:	OFF to +10dB
CONTROL-ROOM range:	OFF to +10dB
Hum & Noise	<-80dB@20Hz~22KHz A-weighted 1 channel & MAIN level:0dB, the other: minimum
Crosstalk	<-80dB@0dB 20Hz~22KHz A-weighted MAIN level: 0dB, the other: minimum

USB-B Port:	Audio in- & output interface for PC & Mac, 48 KHz,16 bit
USB-A Port:	5V-500mA power supply

Media player

Connection format:	USB-A socket
File system:	FAT16 or FAT32 (MP3)

Design and product specifications are subject to change without prior notice.



Website: www.Dap-audio.info
Email: service@highlite.nl

Dimensions

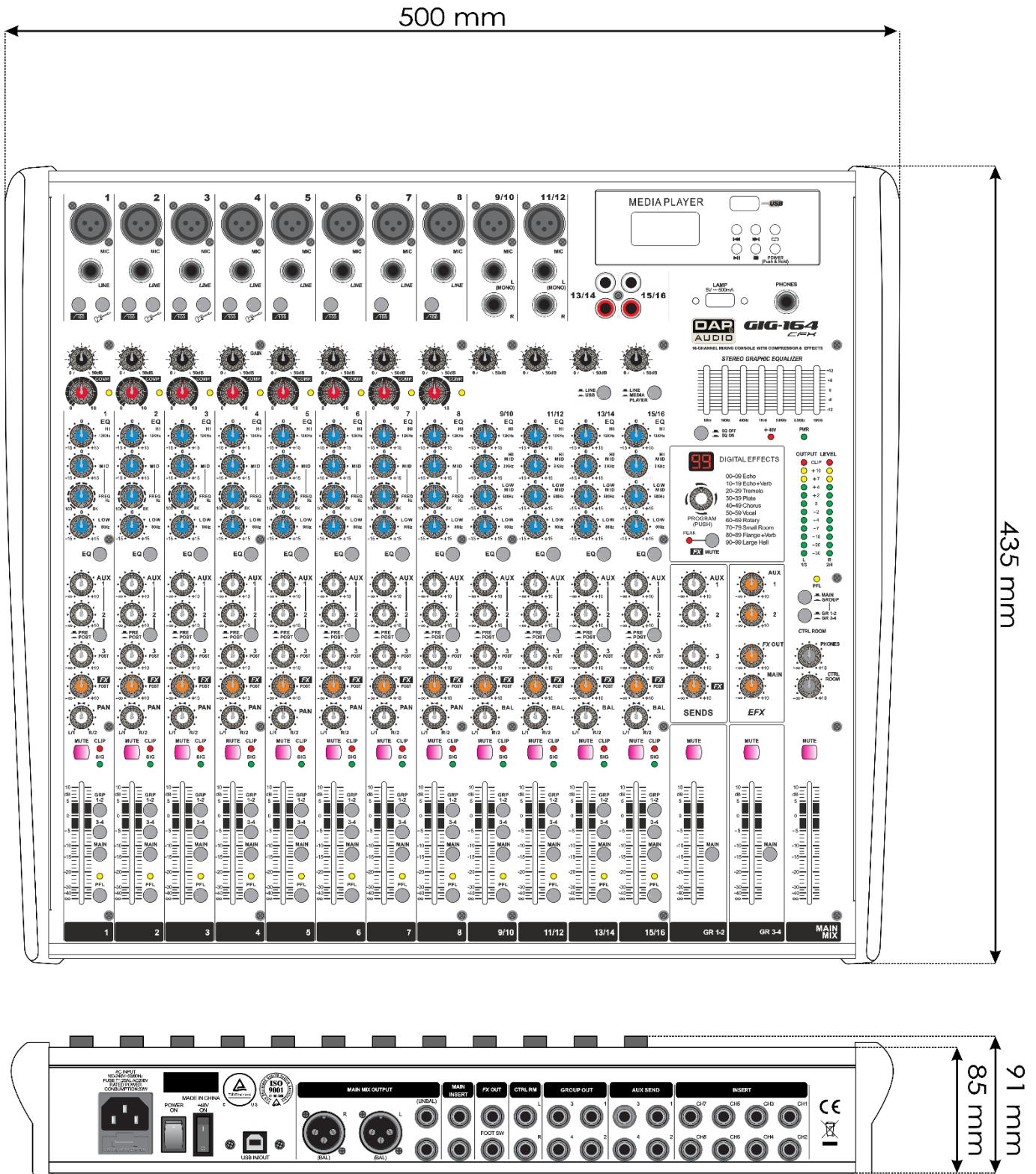



©2018 DAP Audio